



All you need to know ...

Alfa Laval Pump Handbook



First edition 2001

The information provided in this handbook is given in good faith, but Alfa Laval is not able to accept any responsibility for the accuracy of its content, or any consequences that may arise from the use of the information supplied or materials described.

Inside view

This pump handbook has been produced to support pump users at all levels, providing an invaluable reference tool. The handbook includes all the necessary information for the correct selection and successful application of the Alfa Laval ranges of Centrifugal, Liquid Ring and Rotary Lobe Pumps. The handbook is divided into fifteen main sections, which are as follows:

- | | | | |
|---|--------------------------------|----|--|
| 1 | Introduction | 9 | Motors |
| 2 | Terminology and Theory | 10 | Cleaning Guidelines |
| 3 | Pump Selection | 11 | Compliance with International Standards and Guidelines |
| 4 | Pump Description | 12 | Installation Guide |
| 5 | Pump Materials of Construction | 13 | Troubleshooting |
| 6 | Pump Sealing | 14 | Technical Data |
| 7 | Pump Sizing | 15 | Glossary of Terms |
| 8 | Pump Specification Options | | |

Contents

Section 1: Introduction

Introduction of the Pump Handbook. 5

1.1 What is a Pump? 5

Section 2: Terminology and Theory

Explanation of the terminology and theory of pumping applications, including rheology, flow characteristics, pressure and NPSH. 7

2.1 Product/Fluid Data 8

2.1.1 Rheology 8

2.1.2 Viscosity 8

2.1.3 Density 12

2.1.4 Specific Weight 12

2.1.5 Specific Gravity 13

2.1.6 Temperature 13

2.1.7 Flow Characteristics 13

2.1.8 Vapour Pressure 17

2.1.9 Fluids Containing Solids 17

2.2 Performance Data 18

2.2.1 Capacity (Flow Rate) 18

2.2.2 Pressure 18

2.2.3 Cavitation 30

2.2.4 Net Positive Suction Head (NPSH) 31

2.2.5 Pressure 'Shocks' (Water Hammer) 35

Section 3: Pump Selection

Overview of the pump ranges currently available from Alfa Laval and which particular pumps to apply within various application areas. 39

3.1 General Applications Guide 40

3.2 Pumps for Sanitary Applications 41

3.3 PumpCAS Selection and Configuration Tool 43

Section 4: Pump Description

Description of Alfa Laval pump ranges including design, principle of operation and pump model types. 45

4.1 Centrifugal Pumps 45

4.1.1 General 45

4.1.2 Principle of Operation 46

4.1.3 Design 46

4.1.4 Pump Range 48

4.2 Liquid Ring Pumps 52

4.2.1 General 52

4.2.2 Principle of Operation 52

4.2.3 Design 53

4.2.4 Pump Range 55

4.3 Rotary Lobe Pumps 56

4.3.1 General 56

4.3.2 Principle of Operation 56

4.3.3 Pump Range 57

Section 5: Pump Materials of Construction

Description of the materials, both metallic and elastomeric, that are used in the construction of Alfa Laval pump ranges. 61

5.1 Main Components 61

5.2 Steel Surfaces 63

5.3 Elastomers 65

Section 6: Pump Sealing

Explanation of pump sealing principles with illustrations of the different sealing arrangements used on Alfa Laval pump ranges. A general seal selection guide is included, together with various operating parameters. 67

6.1 Mechanical Seals - General 70

6.2 Mechanical Seal Types in Alfa Laval Pump Ranges 80

6.3 Other Sealing Options (Rotary Lobe Pumps only) 82

Section 7: Pump Sizing

How to size an Alfa Laval pump from product/fluid and performance data given, supported by relevant calculations and worked examples with a simple step by step approach. 85

7.1 General Information Required 85

7.2 Power 86

7.2.1 Hydraulic Power 86

7.2.2 Required Power 87

7.2.3 Torque 88

7.2.4 Efficiency 88

7.3 Centrifugal and Liquid Ring Pumps 92

7.3.1 Flow Curve 92

7.3.2 Flow Control 96

7.3.3 Alternative Pump Installations 100

7.4 Worked Examples of Centrifugal Pump Sizing (Metric Units) 102

7.4.1 Example 1 102

7.4.2 Example 2 106

7.5 Worked Examples of Centrifugal Pump Sizing (US Units) 109

7.5.1 Example 1 109

7.5.2 Example 2 113

7.6 Rotary Lobe Pumps 116

7.6.1 Slip 116

7.6.2 Initial Suction Line Sizing 118

7.6.3 Performance Curve 119

7.6.4 Pumps fitted with Bi-lobe Rotors (Stainless Steel) 124

7.6.5 Pumps fitted with Bi-lobe Rotors (Non Galling Alloy) 125

7.6.6 Pumps fitted with Tri-lobe Rubber Covered Rotors 125

7.6.7 Pumps with Electropolished Surface Finish 126

7.6.8 Guidelines for Solids Handling 127

7.6.9 Guidelines for Pumping Shear Sensitive Media 128

7.7 Worked Examples of Rotary Lobe Pump Sizing (Metric Units) 129

7.8 Worked Examples of Rotary Lobe Pump Sizing (US Units) 143

Section 8: Pump Specifications Options

Description of the various specification options available for the Alfa Laval pump ranges, such as port connections, heating/cooling jackets, pressure relief valves and other ancillaries.

8.1	Centrifugal and Liquid Ring Pumps	157
8.1.1	Port Connections	157
8.1.2	Heating/Cooling Jackets	158
8.1.3	Pump Casing with Drain	159
8.1.4	Increased Impeller Gap	159
8.1.5	Pump Inlet Inducer	159
8.2	Rotary Lobe Pumps	160
8.2.1	Rotor Form	160
8.2.2	Clearances	162
8.2.3	Port Connections	164
8.2.4	Rectangular Inlets	165
8.2.5	Heating/Cooling Jackets and Saddles	166
8.2.6	Pump Overload Protection	167
8.2.7	Ancillaries	169

Section 9: Motors

Description of electric motors, including information on motor protection, methods of starting, motors for hazardous environments and speed control.

9.1	Output Power	175
9.2	Rated Speed	175
9.3	Voltage	176
9.4	Cooling	176
9.5	Insulation and Thermal Rating	176
9.6	Protection	177
9.7	Methods of Starting	179
9.8	Motors for Hazardous Environments	180
9.9	Energy Efficient Motors	182
9.10	Speed Control	184
9.11	Changing Motor Nameplates - Centrifugal and Liquid Ring Pumps only	186

Section 10: Cleaning Guidelines

Advises cleaning guidelines for use in processes utilising CIP (Clean In Place) systems. Interpretations of cleanliness are given and explanations of the cleaning cycle.

Section 11: Compliance with International Standards and Guidelines

Description of the international standards and guidelines applicable to Alfa Laval pump ranges.

Section 12: Installation Guide

Advises guidelines relating to pump installation, system design and pipework layout.

12.1	General	199
12.1.1	System Design	199
12.1.2	Pipework	200
12.1.3	Weight	200
12.1.4	Electrical Supply	200

12.2	Flow Direction	201
12.2.1	Centrifugal Pumps	201
12.2.2	Rotary Lobe Pumps	202
12.3	Baseplates Foundation (Rotary Lobe Pumps only)	203
12.4	Coupling Alignment (Rotary Lobe Pumps only)	204
12.5	Special Considerations for Liquid Ring Pumps	204
12.5.1	Pipework	204

Section 13: Troubleshooting

Advises possible causes and solutions to most common problems found in pump installation and operation.

13.1	General	205
13.2	Common Problems	206
13.2.1	Loss of Flow	206
13.2.2	Loss of Suction	206
13.2.3	Low Discharge Pressure	207
13.2.4	Excessive Noise or Vibration	207
13.2.5	Excessive Power	208
13.2.6	Rapid Pump Wear	208
13.2.7	Seal Leakage	208
13.3	Problem Solving Table	209

Section 14: Technical Data

Summary of the nomenclature and formulas used in this handbook. Various conversion tables and charts are also shown.

14.1	Nomenclature	213
14.2	Formulas	214
14.3	Conversion Tables	219
14.3.1	Length	219
14.3.2	Volume	219
14.3.3	Volumetric Capacity	219
14.3.4	Mass Capacity	220
14.3.5	Pressure/Head	220
14.3.6	Force	220
14.3.7	Torque	220
14.3.8	Power	221
14.3.9	Density	221
14.3.10	Viscosity Conversion Table	222
14.3.11	Temperature Conversion Table	224
14.4	Water Vapour Pressure Table	225
14.5	Pressure Drop Curve for 100 m ISO/DIN Tube	226
14.6	Velocity (m/s) in ISO and DIN Tubes at various Capacities	227
14.7	Equivalent Tube Length Table	228
14.7.1	ISO Tube Metric	228
14.7.2	ISO Tube Feet	230
14.7.3	DIN Tube Metric	232
14.7.4	DIN Tube Feet	234
14.8	Moody Diagram	236
14.9	Initial Suction Line Sizing	237
14.10	Elastomer Compatibility Guide	238
14.11	Changing Motor Name Plates	243

Section 15: Glossary of Terms

Explains the various terms found in this handbook.

...if pumps are the question

Alfa Laval is an acknowledged market leader in pumping technology, supplying Centrifugal and Positive Displacement Pumps world-wide to various key application areas such as food, brewery and pharmaceutical.

1. Introduction

This section gives a short introduction of the Pump Handbook.

1.1 What is a Pump?

There are many different definitions of this but at Alfa Laval we believe this is best described as:

‘A machine used for the purpose of transferring quantities of fluids and/or gases, from one place to another’.

This is illustrated below transferring fluid from tank A to spray nozzles B.

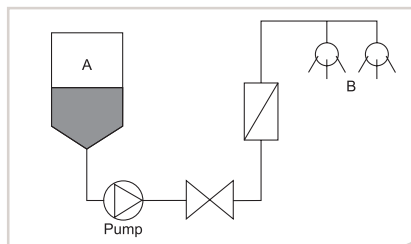

Fig. 1.1a Typical pump installation

Pump types generally fall into two main categories - Rotodynamic and Positive Displacement, of which there are many forms as shown in Fig. 1.1b.

The Rotodynamic pump transfers rotating mechanical energy into kinetic energy in the form of fluid velocity and pressure. The Centrifugal and Liquid Ring pumps are types of rotodynamic pump, which utilise centrifugal force to transfer the fluid being pumped.

The Rotary Lobe pump is a type of positive displacement pump, which directly displaces the pumped fluid from pump inlet to outlet in discrete volumes.

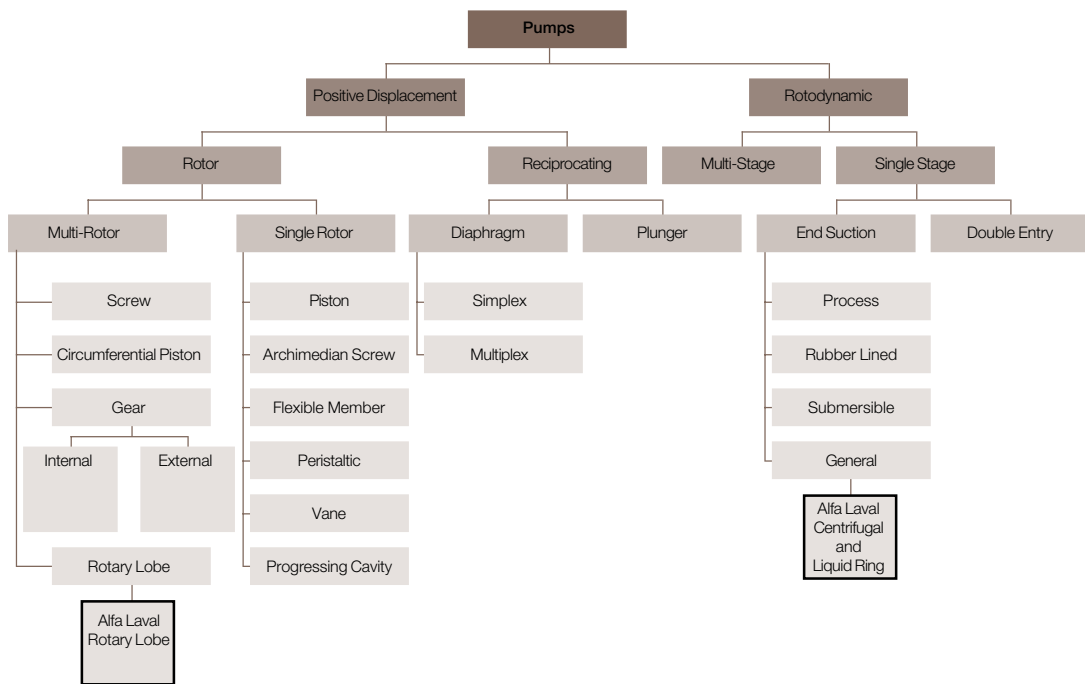

Fig. 1.1b Pump classifications

2. Terminology and Theory

This section explains the terminology and theory of pumping applications, including explanations of rheology, flow characteristics, pressure and NPSH.

In order to select a pump two types of data are required:

- Product/Fluid data which includes viscosity, density/specific gravity, temperature, flow characteristics, vapour pressure and solids content.
- Performance data which includes capacity or flow rate, and inlet/discharge pressure/head.

Different fluids have varying characteristics and are usually pumped under different conditions. It is therefore very important to know all relevant product and performance data before selecting a pump.

2.1 Product/Fluid Data

2.1.1 Rheology

The science of fluid flow is termed 'Rheology' and one of its most important aspects is viscosity which is defined below.

2.1.2 Viscosity

The viscosity of a fluid can be regarded as a measure of how resistive the fluid is to flow, it is comparable to the friction of solid bodies and causes a retarding force. This retarding force transforms the kinetic energy of the fluid into thermal energy.

The ease with which a fluid pours is an indication of its viscosity. For example, cold oil has a high viscosity and pours very slowly, whereas water has a relatively low viscosity and pours quite readily. High viscosity fluids require greater shearing forces than low viscosity fluids at a given shear rate. It follows therefore that viscosity affects the magnitude of energy loss in a flowing fluid.

Two basic viscosity parameters are commonly used, **absolute** (or **dynamic**) viscosity and **kinematic** viscosity.

Absolute (or Dynamic) Viscosity

This is a measure of how resistive the flow of a fluid is between two layers of fluid in motion. A value can be obtained directly from a rotational viscometer which measures the force needed to rotate a spindle in the fluid. The SI unit of absolute viscosity is (mPa.s) in the so-called MKS (metre, kilogram, second) system, while in the cgs (centimetres, grams, seconds) system this is expressed as 1 centipoise (cP) where 1 mPa.s = 1 cP. Water at 1 atmosphere and 20°C (68°F) has the value of 1 mPa.s or 1 cP. Absolute viscosity is usually designated by the symbol μ .

Kinematic Viscosity

This is a measure of how resistive the flow of a fluid is under the influence of gravity. Kinematic viscometers usually use the force of gravity to cause the fluid to flow through a calibrated orifice, while timing its flow. The SI unit of kinematic viscosity is (mm²/s) in the so-called MKS (metre, kilogram, second) system, while in the cgs (centimetres, grams, seconds) system this is expressed as 1 centistoke (cSt), where 1 mm²/s = 1 cSt. Water at 1 atmosphere and 20°C (68°F) has the value of 1 mm²/s = 1 cSt. Kinematic viscosity is usually designated by the symbol ν .

Relationship Between Absolute and Kinematic Viscosity

Absolute and Kinematic viscosity are related by:

$$\nu = \frac{\mu}{\rho} \quad \text{where } \rho \text{ is the fluid density (see 2.1.3).}$$

In the cgs system this translates to:

$$\text{Kinematic Viscosity (cSt)} = \frac{\text{Absolute Viscosity (cP)}}{\text{Specific Gravity}}$$

or

$$\text{Absolute Viscosity (cP)} = \text{Kinematic Viscosity (cSt)} \times \text{SG}$$

A viscosity conversion table is included in 14.3.10.

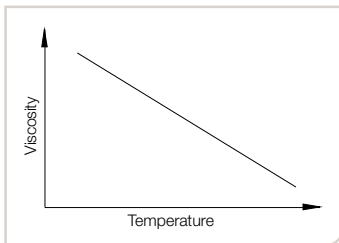

Fig. 2.1.2a Viscosity variation with temperature

Viscosity Variation with Temperature

Temperature can have a significant effect on viscosity and a viscosity figure given for pump selection purposes without fluid temperature is often meaningless - viscosity should always be quoted at the pumping temperature. Generally viscosity falls with increasing temperature and more significantly, it increases with falling temperature. In a pumping system it can be advantageous to increase the temperature of a highly viscous fluid to ease flow.

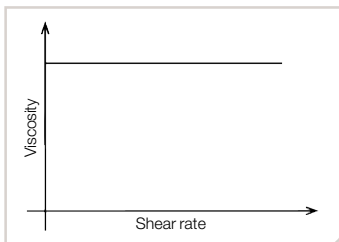

Fig. 2.1.2b Newtonian Fluids

Newtonian Fluids

In some fluids the viscosity is constant regardless of the shear forces applied to the layers of fluid. These fluids are named Newtonian fluids. At a constant temperature the viscosity is constant with change in shear rate or agitation.

Typical fluids are:

- Water • Beer • Hydrocarbons • Milk • Mineral Oils • Resins • Syrups

It is not always obvious which type of viscous behaviour a fluid will exhibit and consideration must be given to the shear rate that will exist in the pump under pumping conditions. It is not unusual to find the effective viscosity as little as 1% of the value measured by standard instruments.

Non-Newtonian Fluids

Most empirical and test data for pumps and piping systems has been developed using Newtonian fluids across a wide range of viscosities. However, there are many fluids which do not follow this linear law, these fluids are named Non-Newtonian fluids.

When working with Non-Newtonian fluids we use Effective Viscosity to represent the viscous characteristics of the fluid as though it was newtonian at that given set of conditions (shear rate, temperature). This effective viscosity is then used in calculations, charts, graphs and 'handbook' information.

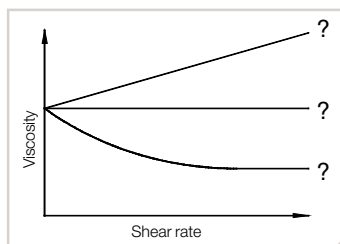

Fig. 2.1.2c Viscosity against shear rate

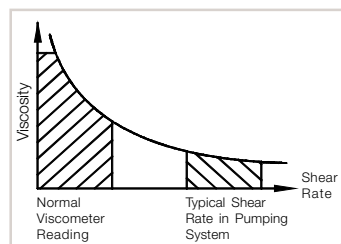

Fig. 2.1.2d Viscosity against shear rate

Types of Non-Newtonian Fluids

There are a number of different type of non-newtonian fluids each with different characteristics. Effective viscosity at set conditions will be different depending on the fluid being pumped. This can be better understood by looking at the behaviour of viscous fluids with changes in shear rate as follows.

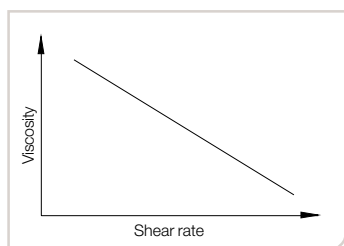

Fig. 2.1.2e Pseudoplastic Fluids

Pseudoplastic Fluids

Viscosity decreases as shear rate increases, but initial viscosity may be so high as to prevent start of flow in a normal pumping system.

Typical fluids are:

- Blood • Emulsions • Gums • Lotions • Soap • Toothpaste • Yeast

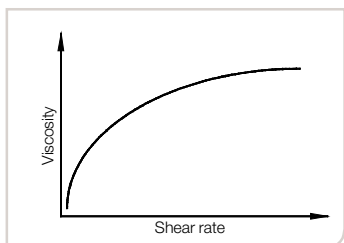

Fig. 2.1.2f Dilatant Fluids

Dilatant Fluids

Viscosity increases as shear rate increases.

Typical fluids are:

- Clay Slurries • Paper Coatings

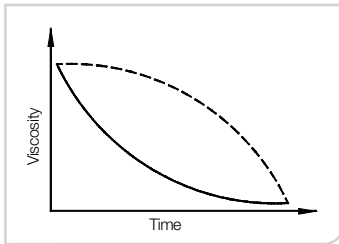

Fig. 2.1.2g Thixotropic Fluids

Thixotropic Fluids

Viscosity decreases with time under shear conditions. After shear ceases the viscosity will return to its original value - the time for recovery will vary with different fluids.

Typical fluids are:

- Cosmetic Creams • Dairy Creams • Greases • Stabilised Yoghurt

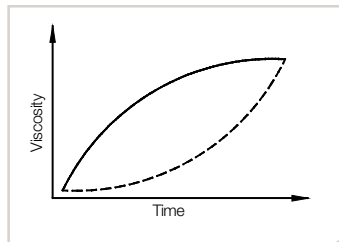

Fig. 2.1.2h Anti-thixotropic Fluids

Anti-thixotropic Fluids

Viscosity increases with time under shear conditions. After shear ceases the viscosity will return to its original value - the time for recovery will vary with different fluids. As the name suggests anti-thixotropic fluids have opposite rheological characteristics to thixotropic fluids.

Typical fluids are:

- Vanadium Pentoxide Solution

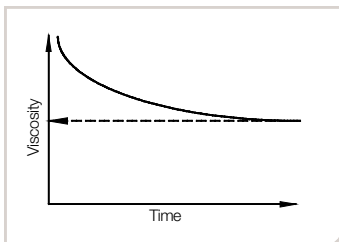

Fig. 2.1.2i Rheomalactic Fluids

Rheomalactic Fluids

Viscosity decreases with time under shear conditions but does not recover. Fluid structure is irreversibly destroyed.

Typical fluids are:

- Natural Rubber Latex • Natural Yoghurt

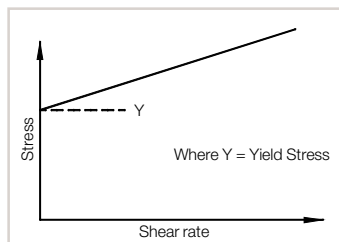

Fig. 2.1.2j Plastic Fluids

Plastic Fluids

Need a certain applied force (or yield stress) to overcome 'solid-like structure', before flowing like a fluid.

Typical fluids are:

- Barium X-ray Meal • Chocolate • Tomato Ketchup

It should be noted that some fluids would have both thixotropic and pseudoplastic behaviour.

Density in gases varies considerably with pressure and temperature but can be regarded as constant in fluids.

2.1.3 Density

The density of a fluid is its mass per unit of volume, usually expressed as kilograms per cubic metre (kg/m^3) or pounds per cubic foot (lb/ft^3). Density is usually designated by the symbol ρ .

1 m^3 of ethyl alcohol has a mass of 789 kg.
i.e. Density = 0.789 kg/m^3 .

1 ft^3 of ethyl alcohol has a mass of 49.2 lb.
i.e. Density = 49.2 lb/ft^3 .

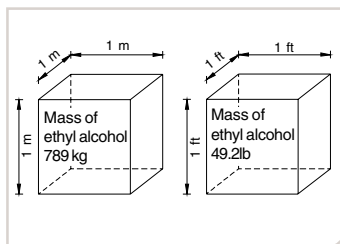

Fig. 2.1.3a Density

2.1.4 Specific Weight

The specific weight of a fluid is its weight per unit volume and is usually designated by the symbol γ . It is related to density as follows:

$$\gamma = \rho \times g \quad \text{where } g \text{ is gravity.}$$

The units of weight per unit volume are N/m^3 or lb/ft^3 .

Standard gravity is as follows:

$$g = 9.807 \text{ m/s}^2$$

$$g = 32.174 \text{ ft/s}^2$$

The specific weight of water at 20°C (68°F) and 1 atmosphere is as follows:

$$\gamma = 9790 \text{ N/m}^3 = 62.4 \text{ lb/ft}^3$$

Note! - Mass should not be confused with **weight**. Weight is the force produced from gravity acting on the mass.

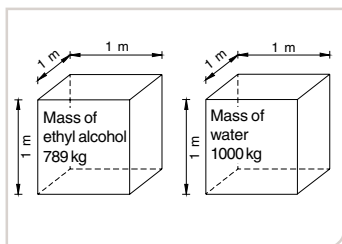

Fig. 2.1.5a Specific gravity

2.1.5 Specific Gravity

The specific gravity of a fluid is the ratio of its density to the density of water. As this is a ratio, it does not have any units of measure.

1 m³ of ethyl alcohol has a mass of 789 kg - its density is 789 kg/m³.

1 m³ of water has a mass of 1000 kg - its density is 1000 kg/m³.

Specific Gravity of ethyl alcohol is: $\frac{789 \text{ kg/m}^3}{1000 \text{ kg/m}^3} = 0.789$

or

1 ft³ of ethyl alcohol has a mass of 49.2 lb - its density is 49.2 lb/ft³.

1 ft³ of water has a mass of 62.4 lb - its density is 62.4 lb/ft³.

Specific Gravity of ethyl alcohol is: $\frac{49.2 \text{ lb/ft}^3}{62.4 \text{ lb/ft}^3} = 0.789$

This resultant figure is dimensionless so the Specific Gravity (or SG) is 0.789.

Temperature is a measure of the internal energy level in a fluid, usually expressed in units of degrees Centigrade (°C) or degrees Fahrenheit (°F).

2.1.6 Temperature

The temperature of the fluid at the pump inlet is usually of most concern as vapour pressure can have a significant effect on pump performance (see 2.1.8). Other fluid properties such as viscosity and density can also be affected by temperature changes. Thus a cooling of the product in the discharge line could have a significant effect on the pumping of a fluid.

The temperature of a fluid can also have a significant affect on the selection of any elastomeric materials used.

A temperature conversion table is given in section 14.3.11.

2.1.7 Flow Characteristics

When considering a fluid flowing in a pipework system it is important to be able to determine the type of flow. The connection between the velocity and the capacity of a fluid (similar to water) in different tube sizes is shown in table 14.6.

Under some conditions the fluid will appear to flow as layers in a smooth and regular manner. This can be illustrated by opening a water tap slowly until the flow is smooth and steady. This type of flow is called **laminar flow**. If the water tap is opened wider, allowing the velocity of flow to increase, a point will be reached whereby the

stream of water is no longer smooth and regular, but appears to be moving in a chaotic manner. This type of flow is called **turbulent flow**. The type of flow is indicated by the **Reynolds number**.

Velocity

Velocity is the distance a fluid moves per unit of time and is given by equation as follows:

In dimensionally consistent SI units

$$\text{Velocity } V = \frac{Q}{A} \quad \text{where } \begin{array}{l} V = \text{fluid velocity (m/s)} \\ Q = \text{capacity (m}^3\text{/s)} \\ A = \text{tube cross sectional area (m}^2\text{)} \end{array}$$

Other convenient forms of this equation are:

$$\text{Velocity } V = \frac{Q \times 353.6}{D^2} \quad \text{where } \begin{array}{l} V = \text{fluid velocity (m/s)} \\ Q = \text{capacity (m}^3\text{/h)} \\ D = \text{tube diameter (mm)} \end{array}$$

or

$$\text{Velocity } V = \frac{Q \times 0.409}{D^2} \quad \text{where } \begin{array}{l} V = \text{fluid velocity (ft/s)} \\ Q = \text{capacity (US gall/min)} \\ D = \text{tube diameter (in)} \end{array}$$

or

$$\text{Velocity } V = \frac{Q \times 0.489}{D^2} \quad \text{where } \begin{array}{l} V = \text{fluid velocity (ft/s)} \\ Q = \text{capacity (UK gall/min)} \\ D = \text{tube diameter (in)} \end{array}$$

Fluid velocity can be of great importance especially when pumping slurries and fluids containing solids. In these instances, a certain velocity may be required to prevent solids from settling in the pipework, which could result in blockages and changes in system pressure as the actual internal diameter of the pipe is effectively decreased, which could impact on pump performance.

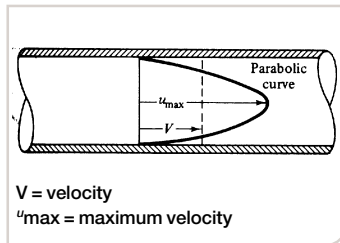

Fig. 2.1.7a Laminar flow

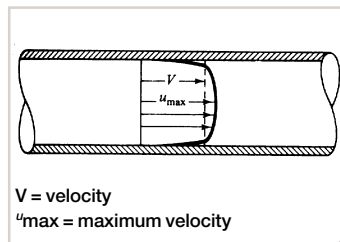

Fig. 2.1.7b Turbulent flow

Laminar Flow

This is sometimes known as streamline, viscous or steady flow. The fluid moves through the pipe in concentric layers with the maximum velocity in the centre of the pipe, decreasing to zero at the pipe wall. The velocity profile is parabolic, the gradient of which depends upon the viscosity of the fluid for a set flow-rate.

Turbulent Flow

This is sometimes known as unsteady flow with considerable mixing taking place across the pipe cross section. The velocity profile is more flattened than in laminar flow but remains fairly constant across the section as shown in fig. 2.1.7b. Turbulent flow generally appears at relatively high velocities and/or relatively low viscosities.

Transitional Flow

Between laminar and turbulent flow there is an area referred to as transitional flow where conditions are unstable and have a blend of each characteristic.

This is a ratio of inertia forces to viscous forces, and as such, a useful value for determining whether flow will be laminar or turbulent.

Reynolds Number (Re)

Reynolds number for pipe flow is given by equation as follows:

In dimensionally consistent SI units

$$Re = \frac{D \times V \times \rho}{\mu} \quad \text{where } D = \text{tube diameter (m)}$$

$V = \text{fluid velocity (m/s)}$
 $\rho = \text{density (kg/m}^3\text{)}$
 $\mu = \text{absolute viscosity (Pa.s)}$

Other convenient forms of this equation are:

$$Re = \frac{D \times V \times \rho}{\mu} \quad \text{where } D = \text{tube diameter (mm)}$$

$$V = \text{fluid velocity (m/s)}$$

$$\rho = \text{density (kg/m}^3\text{)}$$

$$\mu = \text{absolute viscosity (cP)}$$

or

$$Re = \frac{21230 \times Q}{D \times \mu} \quad \text{where } D = \text{tube diameter (mm)}$$

$$Q = \text{capacity (l/min)}$$

$$\mu = \text{absolute viscosity (cP)}$$

or

$$Re = \frac{3162 \times Q}{D \times \nu} \quad \text{where } D = \text{tube diameter (in)}$$

$$Q = \text{capacity (US gall/min)}$$

$$\nu = \text{kinematic viscosity (cSt)}$$

or

$$Re = \frac{3800 \times Q}{D \times \nu} \quad \text{where } D = \text{tube diameter (in)}$$

$$Q = \text{capacity (UK gall/min)}$$

$$\nu = \text{kinematic viscosity (cSt)}$$

Since Reynolds number is a ratio of two forces, it has no units. For a given set of flow conditions, the Reynolds number will not vary when using different units. It is important to use the same set of units, such as above, when calculating Reynolds numbers.

Re less than 2300	-	Laminar Flow (Viscous force dominates - high system losses)
Re in range 2300 to 4000	-	Transitional Flow (Critically balanced forces)
Re greater than 4000	-	Turbulent Flow (Inertia force dominates - low system losses)

Where transitional flow occurs, frictional loss calculations should be carried out for both laminar and turbulent conditions, and the highest resulting loss used in subsequent system calculations.

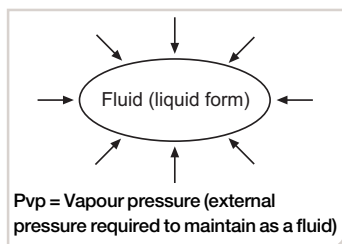

Fig. 2.1.8a Vapour pressure

2.1.8 Vapour Pressure

Fluids will evaporate unless prevented from doing so by external pressure. The vapour pressure of a fluid is the pressure (at a given temperature) at which a fluid will change to a vapour and is expressed as absolute pressure (bar a or *psia*) - see 2.2.2. Each fluid has its own vapour pressure/temperature relationship. In pump sizing, vapour pressure can be a key factor in checking the Net Positive Suction Head (NPSH) available from the system (see 2.2.4).

Temperature	Vapour pressure (bar)
0° C (32° F)	0.006 bar a (0.087 <i>psia</i>)
20° C (68° F)	0.023 bar a (0.334 <i>psia</i>)
100° C (212° F)	1.013 bar a (14.7 <i>psia</i>)

Water will boil (vaporise) at a temperature of:

- 0° C (32° F) if Pvp = 0.006 bar a (0.087 *psia*).
- 20° C (68° F) if Pvp = 0.023 bar a (0.334 *psia*).
- 100° C (212° F) if Pvp = 1.013 bar a (14.7 *psia*) (atmospheric conditions at sea level).

In general terms Pvp:

- Is dependent upon the type of fluid.
- Increases at higher temperature.
- Is of great importance to pump inlet conditions.
- Should be determined from relevant tables.

The Pvp for water at various temperatures is shown in section 14.4.

2.1.9 Fluids Containing Solids

It is important to know if a fluid contains any particulate matter and if so, the size and concentration. Special attention should be given regarding any abrasive solids with respect to pump type and construction, operating speed and shaft seals.

Size of solids is also important, as when pumping large particles the pump inlet should be large enough for solids to enter the pump without 'bridging' the pump inlet. Also the pump should be sized so the cavity created in the pump chamber by the pump elements is of sufficient size to allow satisfactory pump operation.

Concentration is normally expressed as a percentage by weight (W/W) or volume (V/V) or a combination of both weight and volume (W/V).

2.2 Performance Data

2.2.1 Capacity (Flow Rate)

The capacity (or flow rate) is the volume of fluid or mass that passes a certain area per time unit. This is usually a known value dependent on the actual process. For fluids the most common units of capacity are litres per hour (l/h), cubic metres per hour (m³/h) and *UK or US gallons per minute (gall/min)*. For mass the most common units of capacity are kilogram per hour (kg/h), tonne per hour (t/h) and *pounds per hour (lb/h)*.

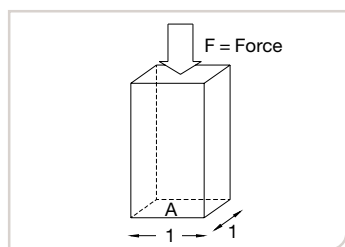

Fig. 2.2.2a Pressure

2.2.2 Pressure

Pressure is defined as force per unit area:
$$P = \frac{F}{A}$$

where F is the force perpendicular to a surface and A is the area of the surface.

In the SI system the standard unit of force is the Newton (N) and area is given in square metres (m²). Pressure is expressed in units of Newtons per square metre (N/m²). This derived unit is called the Pascal (Pa). In practice Pascals are rarely used and the most common units of force are bar, *pounds per square inch (lb/in²)* or *psi*, and kilogram per square centimetre (kg/cm²).

Conversion factors between units of pressure are given in section 14.3.5.

Different Types of Pressure

For calculations involving fluid pressures, the measurements must be relative to some reference pressure. Normally the reference is that of the atmosphere and the resulting measured pressure is called gauge pressure. Pressure measured relative to a perfect vacuum is called 'absolute pressure'.

Atmospheric Pressure

The actual magnitude of the atmospheric pressure varies with location and with climatic conditions. The range of normal variation of atmospheric pressure near the earth's surface is approximately 0.95 to 1.05 bar absolute (bar a) or 13.96 to 15.43 *psi gauge (psig)*. At sea level the standard atmospheric pressure is 1.013 bar a or 14.7 *psi absolute (bar a or psia)*.

Gauge Pressure

Using atmospheric pressure as a zero reference, gauge pressure is the pressure within the gauge that exceeds the surrounding atmospheric pressure. It is a measure of the force per unit area exerted by a fluid, commonly indicated in units of barg (bar gauge) or *psig* (*psi gauge*).

Absolute Pressure

Is the total pressure exerted by a fluid. It equals atmospheric pressure plus gauge pressure, indicated in units of bar a (bar absolute) or *psia* (*psi absolute*).

Absolute Pressure = Gauge Pressure + Atmospheric Pressure

Vacuum

This is a commonly used term to describe pressure in a pumping system below normal atmospheric pressure. This is a measure of the difference between the measured pressure and atmospheric pressure expressed in units of mercury (Hg) or units of *psia*.

$0\text{ psia} = 760\text{ mm Hg}$ (29.9 in Hg).

$14.7\text{ psia} = 0\text{ mm Hg}$ (0 in Hg).

Inlet (Suction) Pressure

This is the pressure at which the fluid is entering the pump. The reading should be taken whilst the pump is running and as close to the pump inlet as possible. This is expressed in units of absolute bar a (*psia*) or gauge bar g (*psig*) depending upon the inlet conditions.

Outlet (Discharge) Pressure

This is the pressure at which the fluid leaves the pump. Again this reading should be taken whilst the pump is running and as close to the pump outlet as possible. The reading is expressed in units of gauge bar (*psig*).

Differential Pressure

This is the difference between the inlet and outlet pressures. For inlet pressures above atmospheric pressure the differential pressure is obtained by subtracting the inlet pressure from the outlet pressure. For inlet pressures below atmospheric pressure the differential pressure is obtained by adding the inlet pressure to the outlet pressure. It is therefore the total pressure reading and is the pressure against which the pump will have to operate. Power requirements are to be calculated on the basis of differential pressure.

Example: Inlet Pressure above Atmospheric Pressure

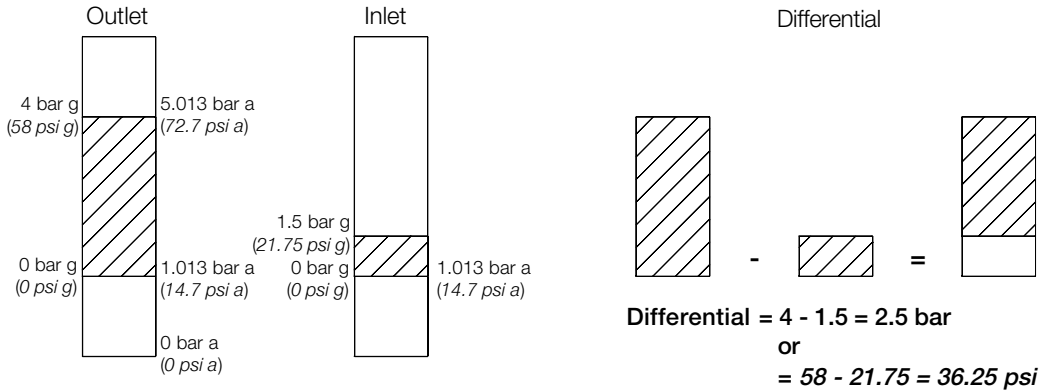

Example: Inlet Pressure below Atmospheric Pressure

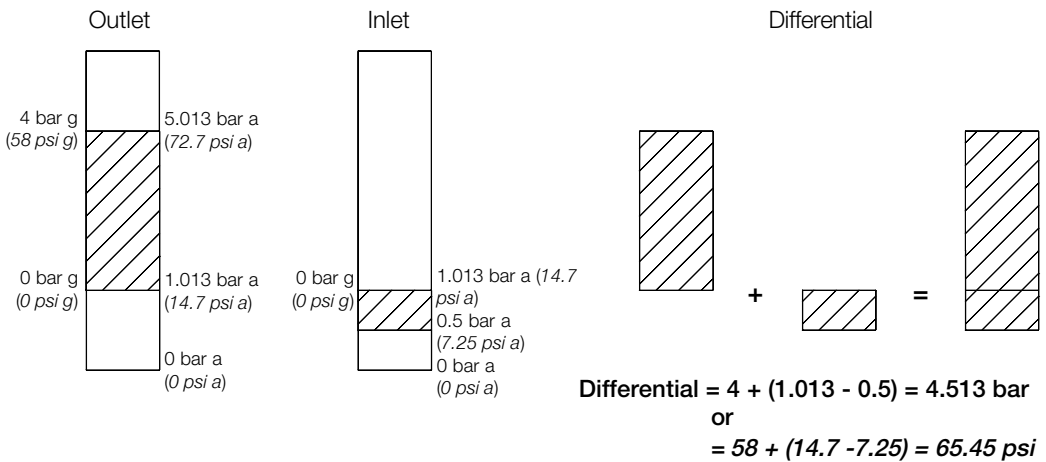

Fig. 2.2.2b Differential pressure

The relationship of elevation equivalent to pressure is commonly referred to as 'head'.

Fig. 2.2.2c Relationship of pressure to elevation

The Relationship Between Pressure and Elevation

In a static fluid (a body of fluid at rest) the pressure difference between any two points is in direct proportion only to the vertical distance between the points. The same vertical height will give the same pressure regardless of the pipe configuration in between.

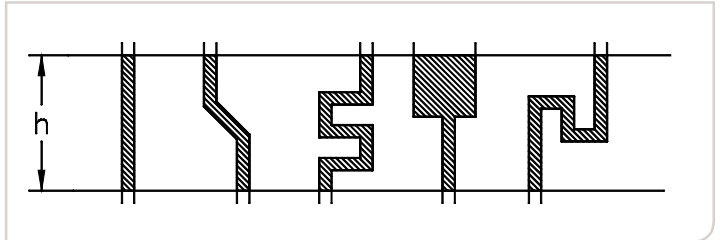

This pressure difference is due to the weight of a 'column' of fluid and can be calculated as follows:

In dimensionally consistent SI units

Static Pressure (P) = $\rho \times g \times h$ where P = Pressure/head (Pa)
 ρ = density of fluid (kg/m^3)
 g = gravity (m/s^2)
 h = height of fluid (m)

Other convenient forms of this equation are:

$$\text{Static Pressure (P)} = \frac{h \text{ (m)} \times SG}{10} \quad (\text{bar})$$

or

$$\text{Static Pressure (P)} = \frac{h \text{ (ft)} \times SG}{2.31} \quad (\text{psi})$$

A pump capable of delivering 35 m (115 ft) head will produce different pressures for fluids of differing specific gravities.

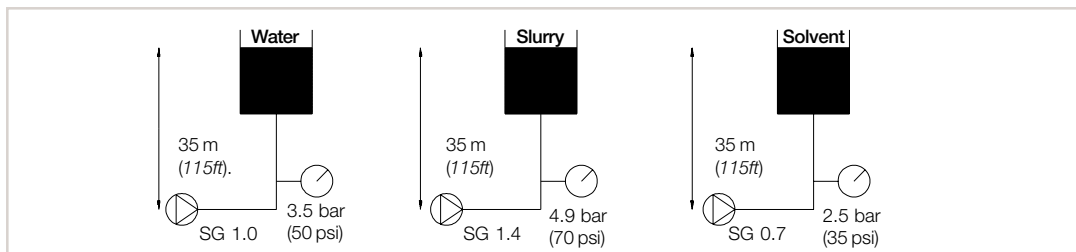

Fig. 2.2.2d Relationship of elevation to pressure

A pump capable of delivering 3.5 bar (50 psi) pressure will develop different amounts of head for fluids of differing specific gravities.

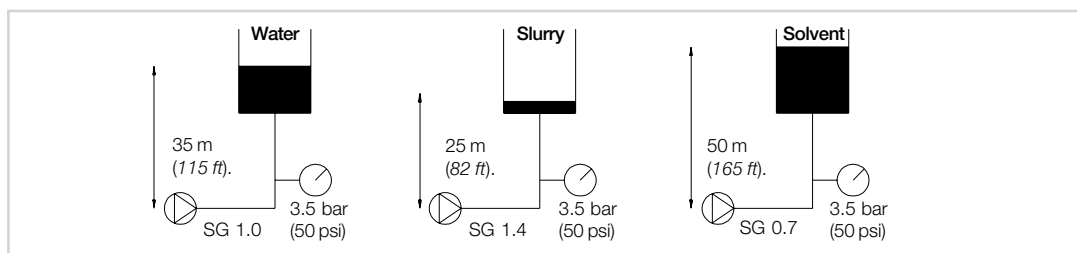

Fig. 2.2.2e Relationship of elevation to pressure

Below are terms commonly used to express different conditions in a pumping system which can be expressed as pressure units (bar or psi) or head units (m or ft).

Flooded Suction

This term is generally used to describe a positive inlet pressure/head, whereby fluid will readily flow into the pump inlet at sufficient pressure to avoid cavitation (see 2.2.3).

Static Head

The static head is a difference in fluid levels.

Static Suction Head

This is the difference in height between the fluid level and the centre line of the pump inlet on the inlet side of the pump.

Static Discharge Head

This is the difference in height between the fluid level and the centre line of the pump inlet on the discharge side of the pump.

Total Static Head

The total static head of a system is the difference in height between the static discharge head and the static suction head.

Friction Head

This is the pressure drop on both inlet and discharge sides of the pump due to frictional losses in fluid flow.

Dynamic Head

This is the energy required to set the fluid in motion and to overcome any resistance to that motion.

Total Suction Head

The total suction head is the static suction head less the dynamic head. Where the static head is negative, or where the dynamic head is greater than the static head, this implies the fluid level will be below the centre line of the pump inlet (ie suction lift).

Total Discharge Head

The total discharge head is the sum of the static discharge and dynamic heads.

Total Head

Total head is the total pressure difference between the total discharge head and the total suction head of the pump. The head is often a known value. It can be calculated by means of different formulas if the installation conditions are specified.

$$\text{Total head } H = H_t - (\pm H_s)$$

$$\text{Total discharge head } H_t = h_t + h_{ft} + p_t$$

$$\text{Total suction head } H_s = h_s - h_{fs} + (\pm p_s)$$

Where:	H	= Total head.
	H_s	= Total suction head.
	H_t	= Total discharge head.
	h_s	= Static suction head.
	h_t	= Static discharge head.
	h_{fs}	= Pressure drop in suction line.
	h_{ft}	= Pressure drop in discharge line.
	P_s	= Vacuum or pressure in a tank on suction side.
	P_t	= Pressure in a tank on discharge side.

In general terms: $p > 0$ for pressure.
 $p < 0$ for vacuum.
 $p = 0$ for open tank.
 $h_s > 0$ for flooded suction.
 $h_s < 0$ for suction lift.

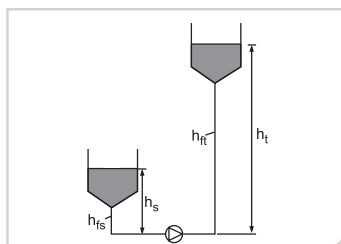

Fig. 2.2.2f Flooded suction and open discharge tanks

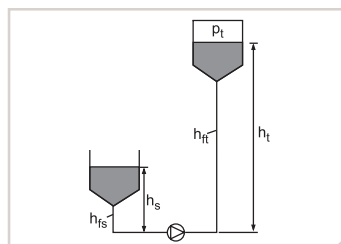

Fig. 2.2.2g Flooded suction and closed discharge tanks

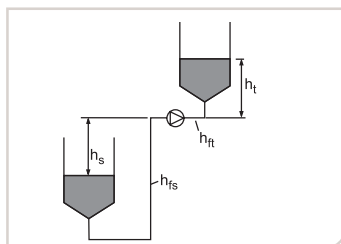

Fig. 2.2.2h Suction lift and open discharge tanks

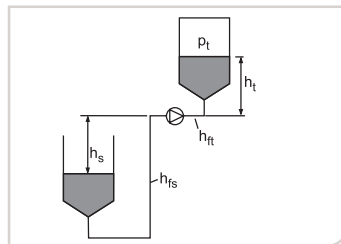

Fig. 2.2.2i Suction lift and closed discharge tanks

Pressure drop is the result of frictional losses in pipework, fittings and other process equipment etc.

Pressure Drop

Manufacturers of processing equipment, heat exchangers, static mixers etc, usually have data available for pressure drop. These losses are affected by fluid velocity, viscosity, tube diameter, internal surface finish of tube and tube length.

The different losses and consequently the total pressure drop in the process are, if necessary, determined in practice by converting the losses into equivalent straight length of tube which can then be used in subsequent system calculations.

For calculations on water like viscosity fluids, the pressure drop can be determined referring to the Pressure Drop Curve (see 14.5) as shown in Example 1. For higher viscosity fluids, a viscosity correction factor is applied to the tube fittings by multiplying the resultant equivalent tube length by the figures shown below - see Example 2.

Table 2.2.2a

Viscosity - cP	1 - 100	101 - 2000	2001 - 20000	20001 - 100000
Correction Factor	1.0	0.75	0.5	0.25

Example 1:

Fig. 2.2.2j Example

Process:

Pumping milk from tank A to tank G.

$Q = 8 \text{ m}^3/\text{h}$ (35 US gall/min).

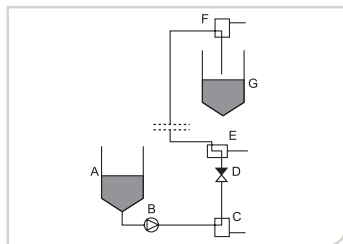
Tubes, valves and fittings:

A: Tank outlet dia. 63.5 mm (2.5 in).

A-B: 4 m (13 ft) tube dia. 63.5 mm (2.5 in).

A-B: 1 off bend 90 deg. dia. 63.5 mm (2.5 in).

B-C: 20 m (66 ft) tube dia. 51 mm (2 in).

C: Seat valve type SRC-W-51-21-100.

C-E: 15 m (49 ft) tube dia. 51 mm (2 in).

B-E: 3 off bend 90 deg. dia. 51 mm (2 in).

D: Non-return valve type LKC-2, 51 mm (2 in).

E: Seat valve type SRC-W-51-21-100.

E-F: 46 m (151 ft) tube dia. 38 mm (1.5 in).

E-F: 4 off bend 90 deg. dia. 38 mm (1.5 in).

F: Seat valve type SRC-W-38-21-100.

The pressure drop through the tubes, valves and fittings is determined as equivalent tube length, so that the total pressure drop can be calculated.

The conversion into equivalent tube length is carried out by reference to section 14.7. This results in the following equivalent tube length for the different equipment as shown in the following tables:

Table 2.2.2b

Equipment	Equivalent ISO Tube Length (m)		
	38 mm	51 mm	63.5 mm
A Tank outlet			1 (estimated)
A-B Tube			4
A-B Bend 90 deg.			1 x 1
B-C Tube		20	
C-E Tube		15	
C-E SRC seat valve, pos 3		10	
B-E Bend 90 deg.		3 x 1	
D LKC-2 non-return valve		12	
E SRC, seat valve, pos.5		14	
E-F Tube	46		
E-F Bend 90 deg.	4 x 1		
F SRC seat valve, pos.3	4		
Total	54	74	6

Table 2.2.2c

Equipment	Equivalent ISO Tube Length (ft)		
	1.5 in	2 in	2.5 in
A Tank outlet			3 (estimated)
A-B Tube			13
A-B Bend 90 deg.			1 x 3
B-C Tube		66	
C-E Tube		49	
C-E SRC seat valve, pos.3		33	
B-E Bend 90 deg.		3 x 3	
D LKC-2 non-return valve		39	
E SRC seat valve, pos.5		46	
E-F Tube	151		
E-F Bend 90 deg.	4 x 3		
F SRC seat valve, pos.3	13		
Total	176	242	19

As viewed from the tables above the pressure drop through the different equipment corresponds to the following equivalent tube length.

- 38 mm (1.5 in) tube: Length = 54 m (176 ft).
- 51 mm (2 in) tube: Length = 74 m (242 ft).
- 63.5 mm (2.5 in) tube: Length = 6 m (19 ft).

The pressure drop through 100 m of tube for sizes 38 mm, 51 mm and 63.5 mm is determined by means of the following curve, also shown in 14.5.

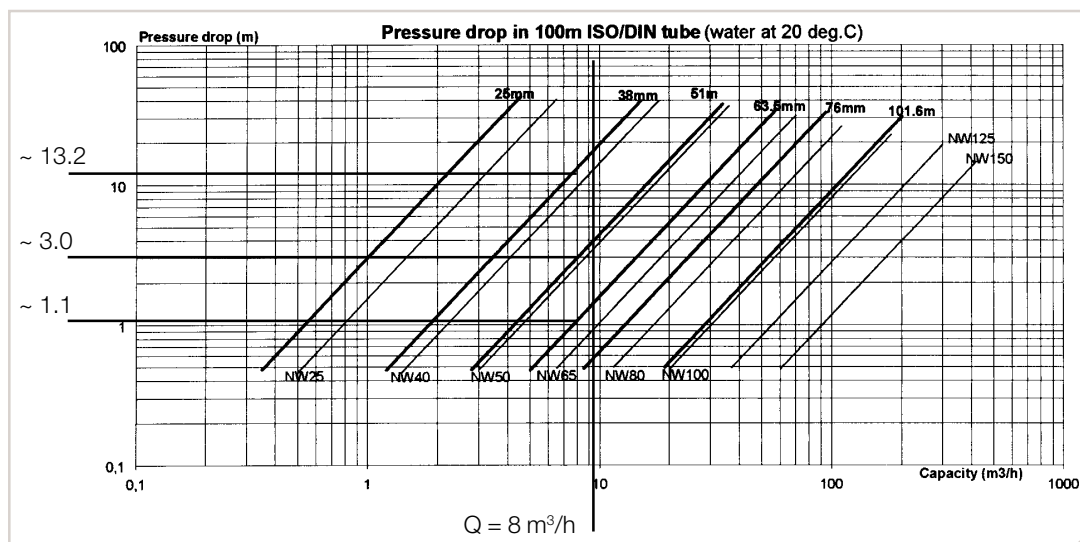

Fig. 2.2.2k Pressure drop curve

The total pressure drop ΔH in the process is consequently calculated as follows:

$$38 \text{ mm: } \Delta H = \frac{54 \times 13.2}{100} = 7.13 \text{ m}$$

$$51 \text{ mm: } \Delta H = \frac{74 \times 3.0}{100} = 2.22 \text{ m}$$

$$63.5 \text{ mm: } \Delta H = \frac{6 \times 1.1}{100} = 0.07 \text{ m}$$

$$\Delta H = 7.13 + 2.22 + 0.07 = 9.42 \text{ m} \approx 9.4 \text{ m} (\approx 1 \text{ bar})$$

or

$$1.5 \text{ in: } \Delta H = \frac{176 \times 43}{328} = 23.1 \text{ ft}$$

$$2 \text{ in: } \Delta H = \frac{242 \times 10}{328} = 7.4 \text{ ft}$$

$$2.5 \text{ in: } \Delta H = \frac{19 \times 4}{328} = 0.2 \text{ ft}$$

$$\Delta H = 23.1 + 7.4 + 0.2 = 30.7 \text{ ft} \approx 31 \text{ ft} (\approx 14 \text{ psi})$$

Example 2:

Process:

Pumping glucose with a viscosity of 5000 cP from a flooded suction through discharge pipeline as follows.

Tubes, valves and fittings:

30 m (98 ft) tube dia. 51 mm (2 in).

20 m (66 ft) tube dia. 76 mm (3 in).

2 off Non-return valves 51 mm (2 in).

6 off Bend 90 deg. dia. 51 mm (2 in).

4 off Bend 90 deg. dia. 76 mm (3 in).

3 off Tee (out through side port) 51 mm (2 in).

The pressure drop through the tubes, valves and fittings is determined as equivalent tube length so that the total pressure drop can be calculated.

For the pipe fittings the conversion into equivalent tube length is carried out by reference to tables 14.7. This results in the following equivalent tube length for the different fittings as shown below:

Table 2.2.2d

Fittings	Equivalent ISO Tube Length (m)	
	51 mm	76 mm
Non-return valve	2 x 12	
Bend 90 deg.	6 x 1	
Bend 90 deg.		4 x 1
Tee	3 x 3	
Total	39	4

Table 2.2.2e

Fittings	Equivalent ISO Tube Length (ft)	
	2 in	3 in
Non-return valve	2 x 39	
Bend 90 deg.	6 x 3	
Bend 90 deg.		4 x 3
Tee	3 x 10	
Total	126	12

As viewed from the tables above the pressure drop through the different fittings corresponds to the following equivalent tube length.

Tube dia. 51 mm (2 in): Length = 39 m (126 ft).

Tube dia. 76 mm (3 in): Length = 4 m (12 ft).

Applying the viscosity correction factor for 5000 cP the equivalent tube length is now:

Tube dia. 51 mm (2 in): Length = 39 m (126 ft) x 0.5 = 19.5 m (63 ft)

Tube dia. 76 mm (3 in): Length = 4 m (12 ft) x 0.5 = 2 m (6 ft)

These figures of 19.5 m (63 ft) and 2 m (6 ft) would be added to the straight tube lengths given as shown below, and subsequently used in calculating the discharge pressure at the flow rate required.

Tube dia. 51 mm (2 in): 30 m (98 ft) + 19.5 m (63 ft) = 49.5 m (161 ft)

+

Tube dia. 76 mm (3 in): 20 m (66 ft) + 2 m (6 ft) = 22 m (72 ft)

The friction losses in a pipework system are dependent upon the type of flow characteristic that is taking place. The Reynolds number (Re) is used to determine the flow characteristic, see 2.1.7.

Friction Loss Calculations

Since laminar flow is uniform and predictable it is the only flow regime in which the friction losses can be calculated using purely mathematical equations. In the case of turbulent flow, mathematical equations are used, but these are multiplied by a co-efficient that is normally determined by experimental methods. This co-efficient is known as the Darcy friction factor (f_D).

The Miller equation given below can be used to determine the friction losses for both laminar and turbulent flow in a given length of pipe (L).

In dimensionally consistent SI units:

$$Pf = f_D \times L \times \rho \times V^2 \over D \times 2$$

Where:

Pf	= pressure loss due to friction (Pa).
f_D	= Darcy friction factor.
L	= tube length (m).
D	= tube diameter (m).
V	= fluid velocity (m/s).
ρ	= density of fluid (kg/m ³).

Other convenient forms of this equation are:

$$Pf = \frac{5 \times SG \times f_D \times L \times V^2}{D}$$

Where:

Pf	= pressure loss due to friction (bar).
f_D	= Darcy friction factor.
L	= tube length (m).
D	= tube diameter (mm).
V	= fluid velocity (m/s).
SG	= specific gravity.

or

$$Pf = \frac{0.0823 \times SG \times f_D \times L \times V^2}{D}$$

Where:

Pf	= pressure loss due to friction (psi).
f_D	= Darcy friction factor.
L	= tube length (ft).
D	= tube diameter (in).
V	= fluid velocity (ft/s).
SG	= specific gravity.

For laminar flow, the Darcy friction factor (f_D) can be calculated directly from the equation:

$$f_D = \frac{64}{Re}$$

The relative roughness of pipes varies with diameter, type of material used and age of the pipe. It is usual to simplify this by using an relative roughness (k) of 0.045 mm, which is the absolute roughness of clean commercial steel or wrought iron pipes as given by Moody.

For turbulent flow, the Darcy friction factor (f_D) has to be determined by reference to the Moody diagram (see section 14.8). It is first necessary to calculate the relative roughness designated by the symbol ϵ .

Where:

$$\epsilon = \frac{k}{D}$$

k = relative roughness which is the average heights of the pipe internal surface peaks (mm).

D = internal pipe diameter (mm).

The term cavitation is derived from the word cavity, meaning a hollow space.

2.2.3 Cavitation

Cavitation is an undesirable vacuous space in the inlet port of the pump normally occupied by fluid. The lowest pressure point in a pump occurs at the pump inlet - due to local pressure reduction part of the fluid may evaporate generating small vapour bubbles. These bubbles are carried along by the fluid and implode instantly when they get into areas of higher pressure.

If cavitation occurs this will result in loss of pump efficiency and noisy operation. The life of a pump can be shortened through mechanical damage, increased corrosion and erosion when cavitation is present.

When sizing pumps on highly viscous fluids care must be taken not to select too high pump speed so as to allow sufficient fluid to enter the pump and ensure satisfactory operation.

For all pump application problems, cavitation is the most commonly encountered. It occurs with all types of pumps, centrifugal, rotary or reciprocating. When found, excessive pump speed and/or adverse suction conditions will probably be the cause and reducing pump speed and/or rectifying the suction condition will usually eliminate this problem.

Cavitation should be avoided at all costs.

2.2.4 Net Positive Suction Head (NPSH)

In addition to the total head, capacity, power and efficiency requirements, the condition at the inlet of a pump is critical. The system on the inlet side of the pump must allow a smooth flow of fluid to enter the pump at a sufficiently high pressure to avoid cavitation. This is called the **Net Positive Suction Head**, generally abbreviated **NPSH**.

Pump manufacturers supply data about the net positive suction head required by their pumps (NPSH_r) for satisfactory operation. When selecting a pump it is critical the net positive suction head available (NPSH_a) in the system is greater than the net positive suction head required by the pump.

For satisfactory pump operation:

NPSH_a > **NPSH_r**

N.I.P.A. > **N.I.P.R.**

NPSH_a is also referred to as N.I.P.A. (Net Inlet Pressure Available) and NPSH_r is also referred to as N.I.P.R. (Net Inlet Pressure Required).

A simplified way to look at NPSH_a or N.I.P.A. is to imagine a balance of factors working for (static pressure and positive head) and against (friction loss and vapour pressure) the pump.

Fig. 2.2.4a NPSH balance

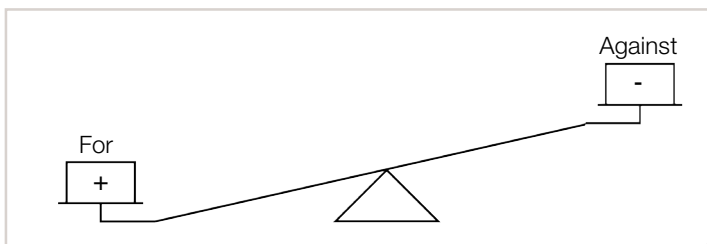

Providing the factors acting for the pump outweigh those factors acting against, there will be a positive suction pressure.

The value of NPSHa or N.I.P.A. in the system is dependent upon the characteristic of the fluid being pumped, inlet piping, the location of the suction vessel, and the pressure applied to the fluid in the suction vessel. This is the actual pressure seen at the pump inlet. It is important to note, it is the inlet system that sets the inlet condition and not the pump. It is calculated as follows:

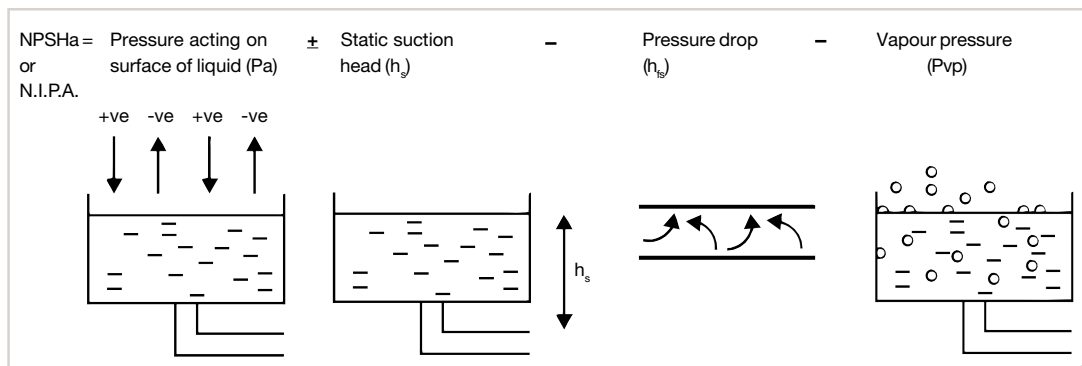

Fig. 2.2.4b NPSH calculation

$$\text{NPSHa or N.I.P.A.} = Pa \pm h_s - h_{fs} - P_{vp}$$

Where:

- Pa = Pressure absolute above fluid level (bar).
- h_s = Static suction head (m).
- h_{fs} = Pressure drop in suction line (m).
- P_{vp} = Vapour pressure (bar a).

or

Where:

- Pa = Pressure absolute above fluid level (psi).
- h_s = Static suction head (ft).
- h_{fs} = Pressure drop in suction line (ft).
- P_{vp} = Vapour pressure (psia).

It is important the units used for calculating NPSHa or N.I.P.A. are consistent i.e. the total figures should be in m or ft.

For low temperature applications the vapour pressure is generally not critical and can be assumed to be negligible.

Example 1:

Fig. 2.2.4c Example

Process:

Water at 50 °C (122° F).

P_a = Pressure absolute above fluid level (1 bar = 10 m)
(14.7 psi = 33.9 ft).

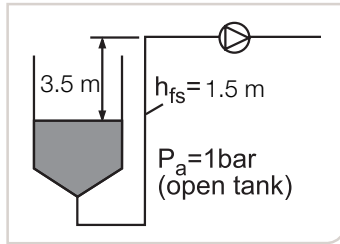
h_s = Static suction head (3.5 m) (11.5 ft).

h_{fs} = Pressure drop in suction line (1.5 m) (5 ft).

P_{vp} = Vapour pressure (0.12 bar a = 1.2 m) (1.8 psia = 4 ft).

NPSHr of pump selected = 3.0 m (10 ft).

$$\begin{aligned} \text{NPSHa} &= P_a - h_s - h_{fs} - P_{vp} &&= P_a - h_s - h_{fs} - P_{vp} \\ &= 10 - 3.5 - 1.5 - 1.2 \text{ (m)} &&\text{or } = 33.9 - 11.5 - 5 - 4 \text{ (ft)} \\ &= 3.8 \text{ m} &&= 13.4 \text{ ft} \end{aligned}$$

As NPSHa is greater than NPSHr, no cavitation will occur under the conditions stated.

Example 2:

Fig. 2.2.4d Example

Process:

Water at 75 °C (167° F).

P_a = Pressure absolute above fluid level (0.5 bar = 5 m)
(7 psi = 16 ft).

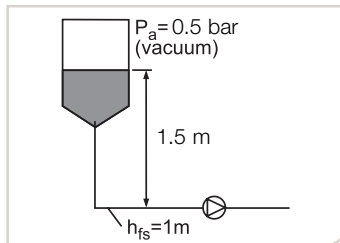
h_s = Static suction head (1.5 m) (5 ft).

h_{fs} = Pressure drop in suction line (1.0 m) (3 ft).

P_{vp} = Vapour pressure (0.39 bar a = 3.9 m) (5.7 psia = 13 ft).

NPSHr of pump selected = 3.0 m (10 ft).

$$\begin{aligned} \text{NPSHa} &= P_a + h_s - h_{fs} - P_{vp} &&= P_a + h_s - h_{fs} - P_{vp} \\ &= 5 + 1.5 - 1.0 - 3.9 \text{ (m)} &&\text{or } = 16 + 5 - 3 - 13 \text{ (ft)} \\ &= 1.6 \text{ m} &&= 5 \text{ ft} \end{aligned}$$

As NPSHa is less than NPSHr, cavitation will occur under the conditions stated.

Example 3:

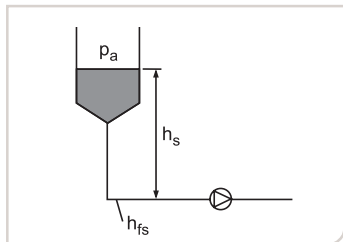

Fig. 2.2.4e Example

Process:
Glucose at 50 °C (122° F).

- Pa = Pressure absolute above fluid level (1 bar = 10 m) (14.7 psi = 33.9 ft).
- h_s = Static suction head (1.5 m) (5 ft).
- h_{fs} = Pressure drop in suction line (9.0 m) (30 ft).
- Pvp = Vapour pressure (assumed negligible = 0 m) (0 ft).

NPSHr of pump selected = 3.0 m (10 ft).

$$\begin{aligned}
 \text{NPSHa} &= Pa + h_s - h_{fs} - Pvp &&= Pa + h_s - h_{fs} - Pvp \\
 &= 10 + 1.5 - 9.0 - 0 \text{ (m)} &&\text{ or } = 33.9 + 5 - 30 - 0 \text{ (ft)} \\
 &= 2.5 \text{ m} &&= 8.9 \text{ ft}
 \end{aligned}$$

As NPSHa is less than NPSHr, cavitation will occur under the conditions stated.

From the NPSHa formula it is possible to check and optimise the conditions which affect NPSHa.

The effects are shown as follows:

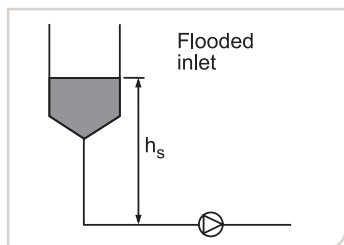

Fig. 2.2.4f Positive effect

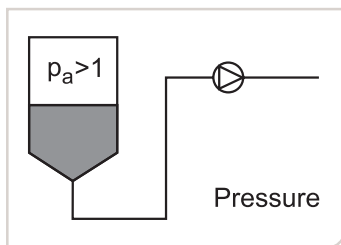

Fig. 2.2.4g Positive effect

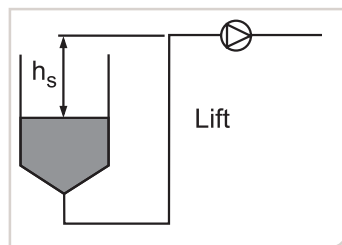

Fig. 2.2.4h Negative effect

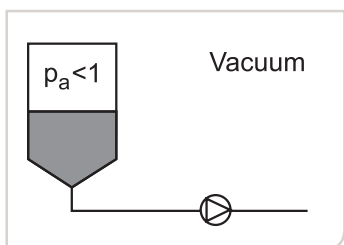

Fig. 2.2.4i Negative effect

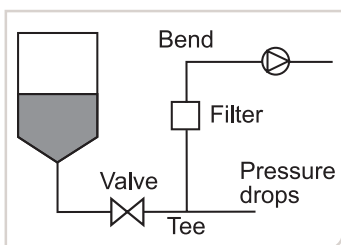

Fig. 2.2.4j Negative effect

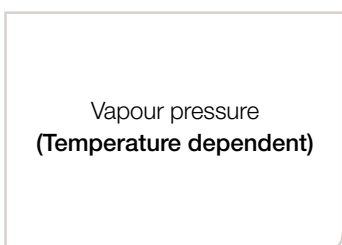

Fig. 2.2.4k Negative effect

Suggestions for avoiding cavitation:

- Keep pressure drop in the inlet line to a minimum i.e. length of line as short as possible, diameter as large as possible, and minimal use of pipe fittings such as tees, valves etc.
- Maintain a static head as high as possible.
- Reduce fluid temperature, although caution is needed as this may have an effect of increasing fluid viscosity, thereby increasing pressure drop.

2.2.5 Pressure 'Shocks' (Water Hammer)

The term 'shock' is not strictly correct as shock waves only exist in gases. The pressure shock is really a pressure wave with a velocity of propagation much higher than the velocity of the flow, often up to 1400 m/s for steel tubes. Pressure waves are the result of rapid changes in the velocity of the fluid in especially in long runs of piping.

The following causes changes in fluid velocity:

- Valves are closed or opened.
- Pumps are started or stopped.
- Resistance in process equipment such as valves, filters, meters, etc.
- Changes in tube dimensions.
- Changes in flow direction.

The major pressure wave problems in process plants are usually due to rapidly closed or opened valves. Pumps, which are rapidly/frequently started or stopped, can also cause some problems.

When designing pipework systems it is important to keep the natural frequency of the system as high as possible by using rigid pipework and as many pipework supports as possible, thereby avoiding the excitation frequency of the pump.

Effects of pressure waves:

- Noise in the tube.
- Damaged tube.
- Damaged pump, valves and other equipment.
- Cavitation.

Velocity of propagation

The velocity of propagation of the pressure wave depends on:

- Elasticity of the tubes.
- Elasticity of the fluid.
- The tubes support.

When for example, a valve is closed, the pressure wave travels from the valve to the end of the tube. The wave is then reflected back to the valve. These reflections are in theory continuing but in practice the wave gradually attenuates cancelled by friction in the tube.

A pressure wave as a result of a pump stopping is more damaging than for a pump starting due to the large change in pressure which will continue much longer after a pump is stopped compared to a pump starting. This is due to the low fluid velocity which results in a relatively small damping of the pressure waves.

A pressure wave induced as a result of a pump stopping can result in negative pressure values in long tubes, i.e. values close to the absolute zero point which can result in cavitation if the absolute pressure drops to the vapour pressure of the fluid.

Precautions

Pressure waves are caused by changes in the velocity of the liquid in especially long runs of tube. Rapid changes in the operating conditions of valves and pump are the major reasons to the pressure waves and therefore, it is important to reduce the speed of these changes.

There are different ways to avoid or reduce pressure waves which are briefly described below.

Correct flow direction

Incorrect flow direction through valves can induce pressure waves particularly as the valve functions. With air-operated seat valves incorrect direction of flow can cause the valve plug to close rapidly against the valve seat inducing pressure waves. Figs 2.2.5a and 2.2.5b specify the correct and incorrect flow direction for this type of valve.

Correct flow directions in the process plant can reduce or even prevent pressure wave problems.

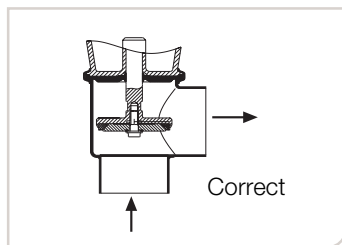

Fig. 2.2.5a Correct flow direction through seat valve

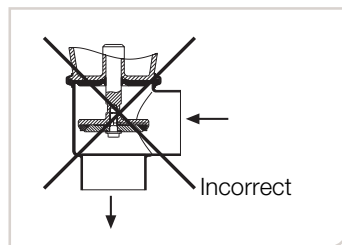

Fig. 2.2.5b Incorrect flow direction through seat valve

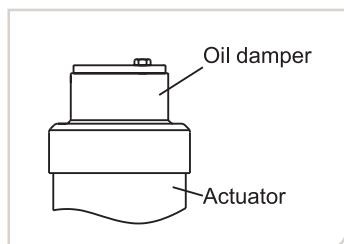

Fig. 2.2.5c Oil damper for seat valve

Damping of valves

The pressure wave induced by a seat valve can be avoided or minimised by damping the movement of the valve plug. The damping is carried out by means of a special damper (see fig. 2.2.5c).

Speed control of pumps

Speed control of a pump is a very efficient way to minimise or prevent pressure waves. The motor is controlled by means of a soft starter or a frequency converter so that the pump is:

- Started at a low speed which is slowly increased to duty speed.
- Stopped by slowly decreasing from duty speed down to a lower speed or zero.

The risk of power failure should be taken into consideration when using speed control against pressure waves.

Equipment for industrial processes

There is various equipment available to reduce pressure waves such as:

- Pressure storage tanks.
- Pressure towers.
- Damped or undamped non-return valves.

These however, may not be suitable for hygienic processes and further advice may be required before they are recommended or used in such installations.

3. Pump Selection

This section gives an overview of the pump ranges currently available from Alfa Laval and which particular pumps to apply within various application areas.

As demands on processes increase, major factors evolve such as the quality of products and process profitability. In view of this, the correct selection of a pump is of great importance.

The pump must be able to carry out various duties under differing conditions.

Some of these are as follows:

- Transfer various types of fluids/products.
- Gentle treatment of the fluids/products.
- Overcome different losses and pressure drops in the system.
- Provide hygienic, economical and long lasting operation.
- Ensure easy and safe installation, operation and maintenance.

As pumps are used in different locations and stages of a process the need for the correct pump in the right place has become increasingly important. It is therefore necessary to be aware of the various problems that might be encountered when selecting a pump.

Some pump problems can be:

- The correct type of pump for the right application.
- The correct design of pump.
- The correct selection of pump with regard to inlet and outlet conditions, product data, operating conditions etc.
- Correct selection of shaft seals.
- Correct selection of drive units.

3.1 General Applications Guide

The table shown below gives a general guide as to the various types of Alfa Laval pump that may be required to suit the application.

General Requirements	Centrifugal	Liquid Ring	Rotary Lobe
Product/Fluid Requirements			
Max. Viscosity	1000 cP	200 cP	1000000 cP
Max. Pumping Temperature	140°C (284°F)	140°C (284°F)	200°C (392°F)
Min. Pumping Temperature	- 10°C (14°F)	- 10°C (14°F)	- 20°C (-4°F)
Ability to pump abrasive products	Not recommended	Not recommended	Fair
Ability to pump fluids containing air or gases	Not recommended	Recommended	Fair
Ability to pump shear sensitive media	Fair	Not recommended	Recommended
Ability to pump solids in suspension	Fair	Not recommended	Recommended
CIP capability (sanitary)	Recommended	Recommended	Recommended
Dry running capability (when fitted with flushed/quench mechanical seals)	Recommended	Recommended	Recommended
Self Draining capability	Recommended	Recommended	Recommended
Performance Requirements			
Max. Capacity - m ³ /hr	440	80	115
Max. Capacity - US gall/min	1936	352	506
Max. Discharge Pressure - bar	20	5.5	20
Max. Discharge Pressure - psig	290	80	290
Ability to vary flow rate	Fair	Not recommended	Recommended
Suction Lift capability (primed wet)	Recommended	Recommended	Recommended
Suction Lift capability (unprimed - dry)	Not recommended	Recommended	Fair
Drive Availability			
Air motor	No	No	Yes
Diesel engine	No	No	Yes
Electric motor	Yes	Yes	Yes
Hydraulic motor	Yes	Yes	Yes
Petrol engine	No	No	Yes
Compliance with International Standards and Guidelines			
3-A	Yes	Yes	Yes
FDA	Yes	Yes	Yes
EHEDG	Yes	No	Yes

Table 3.1a

3.2 Pumps for Sanitary Applications

Alfa Laval Pump Ranges

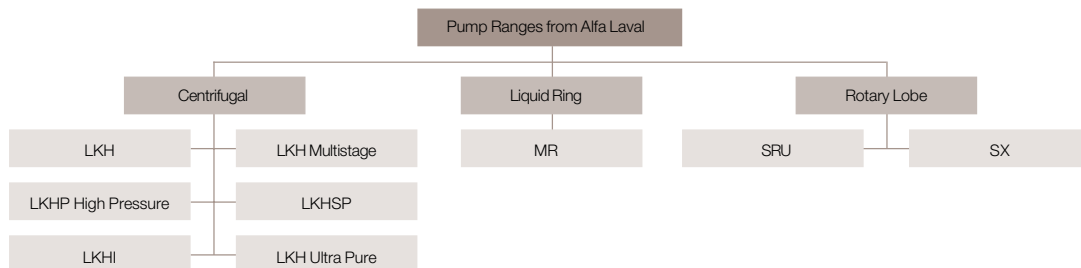

Fig. 3.2a Pump ranges

The following table illustrates which Alfa Laval pump ranges can be used in various sanitary application areas. A detailed description of these pump ranges is given in section 4.

Pump Type	Pump Range	Application Area								
		Brewery	Confectionery	Dairy	Other Food	Pharmaceutical	Soap and Detergent	Soft Drink	Sugar	Water
Centrifugal	LKH	✓	✓	✓	✓	✓	✓	✓	✓	✓
	LKH-Multistage	✓	✓	✓	✓	✓	✓	✓	✓	✓
	LKHP-High Pressure			✓	✓	✓				✓
	LKHSP	✓		✓	✓	✓			✓	
	LKHI	✓	✓	✓	✓	✓	✓	✓	✓	✓
	LKH-Ultra Pure	✓		✓	✓	✓		✓		✓
Rotary Lobe	SRU	✓	✓	✓	✓	✓	✓	✓	✓	
	SX	✓	✓	✓	✓	✓	✓	✓		

Table 3.2a

The Liquid Ring pump is used in most of these sanitary application areas dedicated for CIP and tank emptying duties.

Brewery

Alfa Laval Centrifugal and Rotary Lobe pumps are used in most process stages of brewing from wort handling to beer pasteurisation and filling. Generally, rotary lobe pumps best perform high fluid viscosity applications, such as liquid sugar tanker offloading and malt syrups, whereas low fluid viscosity applications, such as beer and water chilling, are mostly carried out using centrifugal pumps. During the fermentation process, rotary lobe pumps with their gentle pumping action are ideally used handling yeast containing delicate cells.

Confectionery

Alfa Laval is a major supplier of pumping equipment to this industry, providing pumps to all the major confectionery companies. Rotary lobe pumps being used on high viscosity products such as chocolate, glucose, biscuit cream and fondant. Confectionery products that contain particulate matter, such as fruit pie fillings, can be handled with the rotary lobe pump. Centrifugal pumps can be commonly found on fat and vegetable oil applications.

Dairy

Alfa Laval Centrifugal and Rotary Lobe pumps, with their hygienic construction and conforming to 3-A standards (see section 11), are used extensively throughout the dairy industry on milk processing, cream and cultured products such as yoghurt.

Other Food

'Other Food' means other than Confectionery, Dairy and Sugar - generally Alfa Laval Centrifugal and Rotary Lobe pumps can be found on general transfer duties handling products such as petfood, sauces and flavourings.

Pharmaceutical

Alfa Laval Centrifugal and Rotary Lobe pumps can be found on many applications within this industry where hygiene and corrosion resistance is paramount, such as cosmetic creams, protein solutions, toothpaste, perfume, shampoo and blood products.

Soap and Detergent

Alfa Laval Centrifugal and Rotary Lobe pumps can be found on many applications within this industry, handling products such as neat soap, sulphonic acid, fabric conditioner, dishwash liquid, fatty acid, lauryl ether sulphate, liquid detergent and surfactants.

Soft Drink

Alfa Laval Centrifugal pumps are mainly used on applications handling thin liquid sugar solutions, water and flavourings. Alfa Laval Rotary Lobe pumps are mainly used on applications handling high viscosity fruit juice concentrates.

Sugar

Alfa Laval Rotary Lobe pumps, with their ability to handle highly viscosity abrasive products, can be found within many areas of sugar refined products requiring hygienic handling, such as high boiled sugars, glucose solutions and sugar syrups used in confectionery, bakery, brewing and carbonated soft drinks.

Water

Alfa Laval Centrifugal pumps provide a low cost effective solution for high purity water and water like applications.

3.3 PumpCAS Selection and Configuration Tool

Pump selection for both Centrifugal and Rotary Lobe Pumps can be made by the use of Alfa Laval's PumpCAS selection program. This program prompts the user to enter pump duty information and selects the pump from the product range most suited to their specific application. The program selects both centrifugal and rotary lobe pumps and provides the user with a comparison of features enabling the most appropriate technology to be chosen. If one or other technology is not suited to a specific application (this could be due to physical limitations and or fluid characteristics) the program will advise the user, and recommend an alternative solution.

As well as performing the pump selection, PumpCAS also extracts data from a comprehensive liquids database enabling it to suggest viscosity, SG, maximum speed, elastomer compatibility and primary seal configuration. After the pump has been selected, the user will be assisted to complete a detailed pump unit specification. This will include additional options such as pressure relief valves, heating or cooling devices, connection specifications etc. for which the price of the pump and its configuration code (item number) will be automatically generated aiding the quotation and/or ordering process.

If you would like a copy of the Alfa Laval PumpCAS Selection and Configuration Tool please contact your local Alfa Laval sales company.

In addition, PumpCAS will also provide detailed parts list for the pump with item numbers with all recommended spare parts identified and priced. Dimensional details in the form of general arrangement drawings can also be generated.

A link to all technical information that may be required to accompany the quotation such as Operation manuals, generic or specific performance curves, and technical data sheets will also be provided, along with direct access to this Alfa Laval Pump Handbook for any additional supporting information that may be required.

Flexibility has been built in to the software to enable specific enquiries to be answered without the need to complete a full pump selection. For example, recommended spares lists can be extracted based on an existing configuration code or direct access to technical information relating to a specific pump technology is possible.

The liquids database contained within PumpCAS is based on rheological tests performed over many years on end users liquids at Alfa Laval's chemical laboratory, and will be continually added to as additional products are tested. All information is offered for guidance purposes only.

4. Pump Description

This section gives a description of Alfa Laval pump ranges including design, principle of operation and pump model types.

4.1 Centrifugal Pumps

4.1.1 General

The Alfa Laval range of Centrifugal Pumps has been designed specially for use in the food, dairy, beverage, pharmaceutical and light chemical industries. Centrifugal pumps including multi-stage designs and those for high inlet pressure, can handle most low viscosity applications. Centrifugal pumps can provide the most cost effective solution.

Attributes include:

- High efficiency.
- Low power consumption.
- Low noise level.
- Low NPSH requirement.
- Easy maintenance.

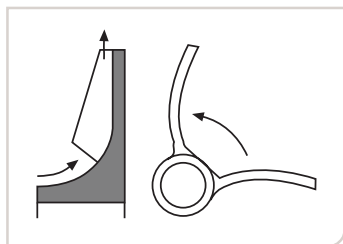

Fig. 4.1.2a Principle of operation

4.1.2 Principle of Operation

Fluid is directed to the impeller eye and is forced into a circular movement by the rotation of the impeller vanes. As a result of this rotation, the impeller vanes transfer mechanical work to the fluid in the impeller channel, which is formed by the impeller vanes. The fluid is then pressed out of the impeller by means of centrifugal force and finally leaves the impeller channel with increased pressure and velocity. The velocity of the fluid is also partly converted into pressure by the pump casing before it leaves the pump through the outlet.

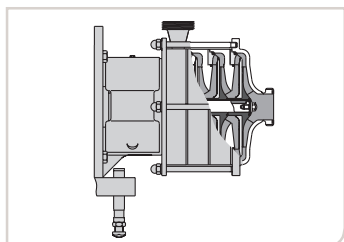

Fig. 4.1.2b Multistage centrifugal pump

The principle of the multi-stage centrifugal pump is the same as the conventional centrifugal pump. The pump consists, however, of several impellers (several stages) which increase the pressure from one stage to another but flow rate is unchanged. The multi-stage centrifugal pump operates as if several conventional centrifugal pumps are connected in series.

4.1.3 Design

In general the Alfa Laval centrifugal pump does not contain many parts, with the pumphead being connected to a standard electric motor. The impeller is fixed onto the pump shaft which is housed in a pump casing and back plate – these components are described below:

Impeller

The impeller is of cast manufacture and open type; i.e. the impeller vanes are open in front. This type allows visual inspection of the vanes and the area between them.

A semi-open impeller is also available which is easy to clean and suitable for polishing.

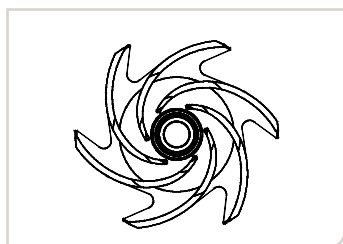

Fig. 4.1.3a Semi-open impeller

The impeller has two or multiple vanes depending on the type of centrifugal pump. The impeller diameter and width will vary dependent upon the duty requirements.

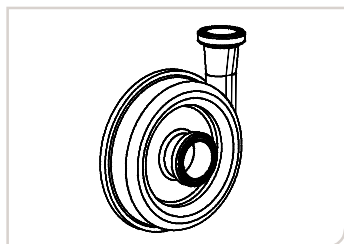

Fig. 4.1.3b Pump casing

Pump Casing

The pump casing is of pressed steel manufacture, complete with male screwed connections and can be supplied with fittings or clamp liners.

The pump casing is designed for multi position outlet, with 360° flexibility.

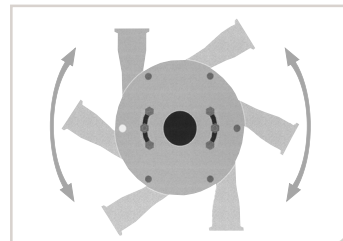

Fig. 4.1.3c 360° flexibility

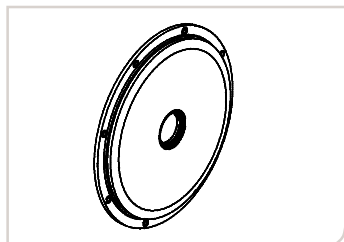

Fig. 4.1.3d Back plate

Back Plate

The back plate is of pressed steel manufacture, which together with the pump casing form the actual fluid chamber in which the fluid is transferred by means of the impeller.

Mechanical Seal

The connection between the motor shaft/pump shaft and the pump casing is sealed by means of a mechanical seal, which is described in section 6.

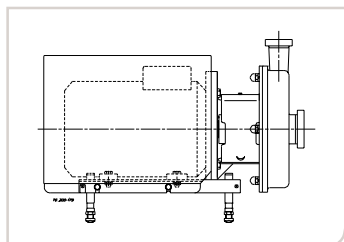

Fig. 4.1.3e Pump with shroud and legs

Shroud and Legs

Most pump types are fitted with shrouds and adjustable legs. The shroud is insulated to keep noise to a minimum and protect the motor against damage.

Please note Alfa Laval Centrifugal pumps for the USA market are supplied without shrouds.

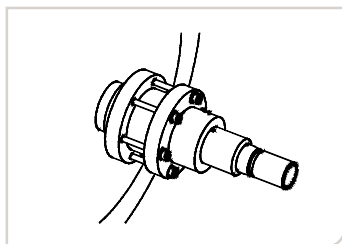

Fig. 4.1.3f Compression coupling

Pump Shaft/Connections

Most pumps have stub shafts that are fixed to the motor shafts by means of compression couplings, eliminating the use of keyways. The stub shaft assembly design provides a simple, yet secure method of drive that reduces vibration and noise. On the multistage centrifugal pump the length of the pump shaft will differ depending upon the number of impellers fitted.

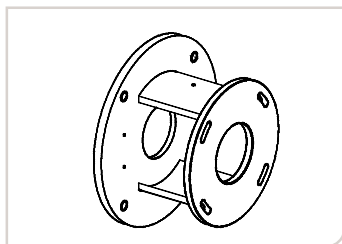

Fig. 4.1.3g Adapter

Adaptor

Most pumps are fitted with a standard IEC electric motor. The connection between the motor and back plate is made by means of an adaptor, which can be attached to any standard IEC or C-frame electric motor.

Pumps supplied with direct coupled motors have no adaptors.

4.1.4 Pump Range

The Alfa Laval Centrifugal Pump portfolio comprises of different ranges as follows:

LKH Range

The LKH pump is a highly efficient and economical centrifugal pump, meeting sanitary requirements with gentle product treatment and chemical resistance.



Fig. 4.1.4a LKH



Fig. 4.1.4b LKH (USA version)

The LKH range is available in twelve sizes: LKH-5, -10, -15, -20, -25, -35, -40, -45, -50, -60, -70 and -80.

Flow rates for 50 Hz up to 440 m³/h (1936 US gall/min) and differential pressures up to 11.5 bar (165 psig) and for 60 Hz up to 440 m³/h (1936 US gall/min) and differential pressure up to 16 bar (230 psig).

LKH-Multistage Range

These pumps are primarily used in applications with high outlet pressure and low capacity requirements such as breweries, reverse osmosis and ultra-filtration. The pumps are available as two, three or four stage models (i.e. pumps fitted with two, three or four impellers respectively).



Fig. 4.1.4c LKH-Multistage



Fig. 4.1.4d LKH-Multistage (USA version)

The LKH-Multistage range is available in six sizes.

Pump Size	Number of Stages
LKH-112	2
LKH-113	3
LKH-114	4
LKH-122	2
LKH-123	3
LKH-124	4

Flow rates for 50 Hz up to 75 m³/h (330 US gall/min) and discharge pressures up to 40 bar (580 psig) with boost pressures up to 19 bar (275 psig) and for 60 Hz up to 80 m³/h (352 US gall/min) and boost pressures up to 26 bar (375 psig).

For inlet pressures greater than 10 bar (145 psig) a 'special' motor is used incorporating fixed angular contact bearings due to axial thrust.

LKHP-High Pressure Range

These pumps are designed to handle high inlet pressures built with reinforced pump casing and back plate. Application areas include reverse osmosis mono-filtration and ultra-filtration.



Fig. 4.1.4e LKHP-High Pressure



Fig. 4.1.4f LKHP-High Pressure (USA version)

The LKHP-High Pressure range is available in nine sizes, LKHP-10, -15, -20, -25, -35, -40, -45, -50 and -60.

The pump range is designed for inlet pressures up to 40 bar (580 psig). Flow rates for 50 Hz up to 240 m³/h (1056 US gall/min) with differential pressures up to 8 bar (115 psig). For 60 Hz, flow rates up to 275 m³/h (1210 US gall/min) with differential pressures up to 11 bar (160 psig).

For these high inlet pressures a 'special' motor with fixed angular contact bearings is used due to axial thrust.

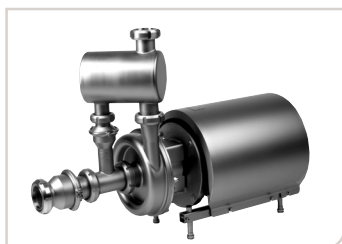

Fig. 4.1.4g LKHSP

LKHSP Range

The LKHSP self-priming pump is specially designed for pumping fluids containing air or gas without losing its pumping ability. The pump is for use in food, chemical, pharmaceutical and other similar industries.

These pumps can be used for tank emptying or as a CIP return pump where there is a risk of air or gas mixing with the fluid in the suction line. The pump is capable of creating a vacuum of 0.6 bar, depending upon pump size.

The pump is supplied complete with a tank, a non-return valve (normally closed) on the inlet side, a tee and a non-return valve (normally open) on the bypass line.

The LKHSP range is available in five sizes, LKHSP-10, -20, -25, -35 and -40.

Flow rates up to 90 m³/h (396 US gall/min) and differential pressures for 50 Hz up to 8 bar (115 psig) and for 60 Hz, 11 bar (160 psig).

LKHI Range

This pump range is similar to the LKH range but is suitable for inlet pressures up to 16 bar (230 psig). The pump can withstand this high inlet pressure due to being fitted with an internal shaft seal.

The LKHI range is available in nine sizes, LKHI-10, -15, -20, -25, -35, -40, -50 and -60.

Flow rates for 50 Hz up to 240 m³/h (1056 US gall/min) with differential pressures up to 8 bar (115 psig). For 60 Hz, flow rates up to 275 m³/h (1210 US gall/min) with differential pressures up to 11 bar (160 psig).

For inlet pressures greater than 10 bar (145 *psig*) a 'special' motor is used incorporating fixed angular contact bearings due to axial thrust.

LKH-UltraPure Range

These pumps are designed for high purity applications such as water-for-injection (WFI). The pump is fully drainable supplied with associated pipework, fittings and valves. Another feature of this pump is self-venting, due to the pump casing outlet being turned 45°.



Fig. 4.1.4h LKH-UltraPure



Fig. 4.1.4i LKH-UltraPure (USA version)

The LKH-UltraPure range is available in five sizes, LKH-UltraPure-10, -20, -25, -35 and -40.

Flow rates up to 90 m³/h (396 *US gall/min*) and differential pressures for 50 Hz up to 8 bar (115 *psig*) and for 60 Hz, 11 bar (160 *psig*).



Fig. 4.1.4j C-Series

C – Series range

The C-Series is the original, all-purpose Alfa Laval centrifugal pump for less demanding applications.

The range is designed for meeting sanitary requirements and can be **Cleaned-In-Place**.

The C-series is produced mainly for the USA and is available in five sizes, C114, C216, C218, C328 and C4410.

Flow rates for 60 Hz up to 227 m³/h (1000 *US gall/min*) and differential pressures up to 10 bar (145 *psig*).

4.2 Liquid Ring Pumps

4.2.1 General

The Alfa Laval range of Liquid Ring Pumps are specially designed for use in food, chemical and pharmaceutical industries where pumping liquids containing air or gases. As the liquid ring pump is self-priming when half filled with fluid, it is capable of pumping from a suction line partly filled with air or gases. As these pumps are self-priming, they are ideally used as return pumps in CIP systems.

Attributes include:

- Self-priming (when pump casing is half filled with fluid).
- Suitable for aerated fluids.
- High efficiency.
- Minimal maintenance.

4.2.2 Principle of Operation

The liquid-ring pump is in principle a centrifugal pump. The pump is, however, self-priming when half filled with fluid. The self-priming capability is a result of the impeller design, small tolerances between the impeller and the pump casing, and due to a side channel made in the pump casing and/or the front cover. The discharge line should be routed 1 to 2 metres vertically upwards from the pump outlet connections to maintain the liquid ring in the side channels (see 12.5.1).

Fig. 4.2.2a Principle of operation

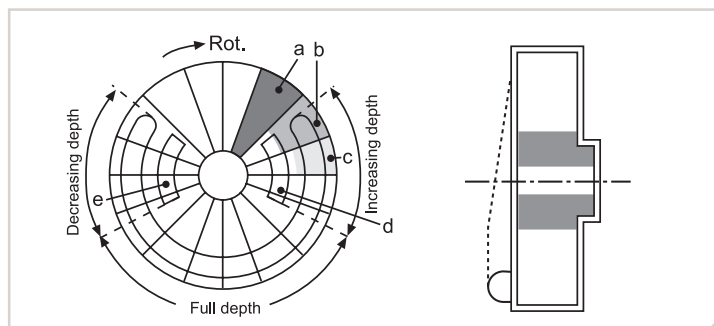

The sequence of a section between two impeller vanes during one revolution is described in the following:

- There is a certain fluid volume in the gap between the vanes which is not in contact with the channel.
- The gap is in contact with the channel, which gradually becomes deeper. Part of the fluid between the vanes fills the channel. The centrifugal force pushes the fluid outwards and consequently forms a vacuum at the centre of the impeller.

- b) to c) The depth of the channel is still increased. The fluid volume is still forced outwards and consequently the fluid-free volume between the vanes is increased until it reaches a maximum where the channel has maximum depth.
- d) The vacuum created induces air from the suction line through the inlet at “d”.
- d) to e) Air and fluid are circulated with the impeller until the depth of the channel begins to decrease. The volume between the vanes is gradually reduced as the depth of the channel is reduced and consequently pressure is build up at the centre of the impeller.
- e) The fluid is still forced outwards and the air remains at the centre of the impeller. The same volume of air that was induced through the inlet is now expelled through the outlet at “e” due to the pressure increase at the centre of the impeller.
- e) to a) The section between the vanes will be refilled with fluid when it has passed the channel as only air and no fluid has yet been pumped. The cycle described above is continuously repeated as the impeller has several sections and rotates at approx. 1500 rev/min. (50 Hz) or 1800 rev/min. (60Hz).

When all the air is removed from the suction line the described cycle is repeated for the fluid. The pump now operates as a fluid pump.

4.2.3 Design

As for centrifugal pumps, the liquid ring pump does not contain many parts – the pumphead being connected to a standard electric motor. The impeller is fixed onto the pump shaft housed in a pump casing and casing cover.

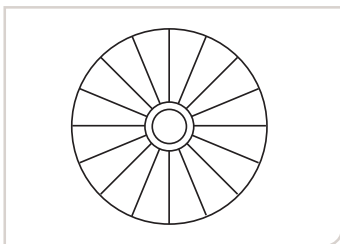

Fig. 4.2.3a Impeller

Impeller

The impeller is of cast manufacture with straight radial impeller vanes. There is only one impeller size for each type of liquid ring pump.

Pump Casing and Casing Cover

The pump casing is of cast manufacture complete with male screwed connections and fittings or clamp liners. The pump casing cover is also of cast manufacture, with or without a channel depending upon pump type/size. The pump casing and casing cover form the actual fluid chamber in which the fluid is transferred by means of the impeller.

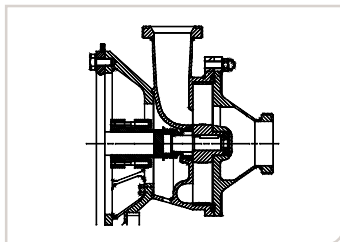

Fig. 4.2.3b Pump with one channel

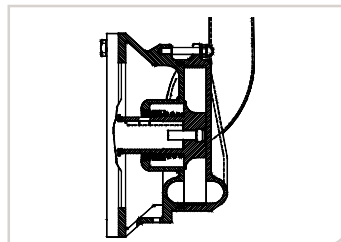

Fig. 4.2.3c Pump with two channels

Mechanical Seal

The connection between the motor shaft/pump shaft and the pump casing is sealed by means of a mechanical seal, which is described in section 6.

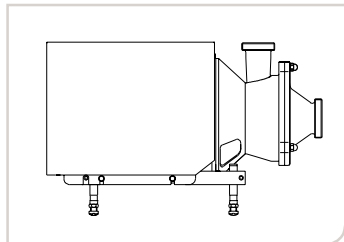

Fig. 4.2.3d Pump with IEC standard motor

Shroud and Legs

Pumps fitted with standard IEC motors utilise the shrouds and legs used on the LKH centrifugal pump range.

Please note Alfa Laval Liquid Ring pumps for the USA market are supplied without shrouds.

Pump Shaft/Connections

Most pumps have stub shafts that are fixed to the motor shafts by means of compression couplings, as used on Centrifugal pumps.

Adaptor

For pumps fitted with a standard IEC electric motor (not MR-300 model), the connection between the motor and pump casing is made by means of an adaptor, similar to that used on Centrifugal pumps.

4.2.4 Pump Range

The Alfa Laval Liquid Ring Pump range is designated the MR range.

MR Range

The MR range is available in four sizes, MR-166S, MR-185S, MR-200S and MR-300.



Fig. 4.2.4a MR-166S, MR-185S and MR-200S



Fig. 4.2.4b MR-300



Fig. 4.2.4c MR pump (USA version)

The pump range is designed for inlet pressures up to 4 bar (60 *psig*). Flow rates up to 80 m³/h (350 *US gall/min*) and differential pressures of 5 bar (73 *psig*) for 50 Hz and 6 bar (87 *psig*) for 60 Hz.

4.3 Rotary Lobe Pumps

4.3.1 General

The Alfa Laval range of Rotary Lobe Pumps with its non-contact pump element design has the ability to cover a wide range of applications in industry. The hygienic design, anti-corrosive stainless steel construction and smooth pumping action have long established these pumps in the food, beverage, dairy and pharmaceutical industries.

Attributes include:

- Gentle transfer of delicate suspended solids.
- Bi-directional operation.
- Compact size with high performance and low energy input.
- Ability to pump shear sensitive media.
- Easy maintenance.

4.3.2 Principle of Operation

Alfa Laval ranges of Rotary Lobe pumps are of conventional design operating with no internal contacting parts in the pump head. The pumping principle is explained with reference to the following diagram, which shows the displacement of fluid from pump inlet to outlet. The rotors are driven by a gear train in the pump gear gearbox providing accurate synchronisation or timing of the rotors. The rotors contra-rotate within the pump head carrying fluid through the pump, in the cavities formed between the dwell of the rotor and the interior of the rotorcase.

In hydraulic terms, the motion of the counter rotating rotors creates a partial vacuum that allows atmospheric pressure or other external pressures to force fluid into the pump chamber. As the rotors rotate an expanding cavity is formed which is filled with fluid. As the rotors separate, each dwell forms a cavity. The meshing of the rotor causes a diminishing cavity with the fluid being displaced into the outlet port.

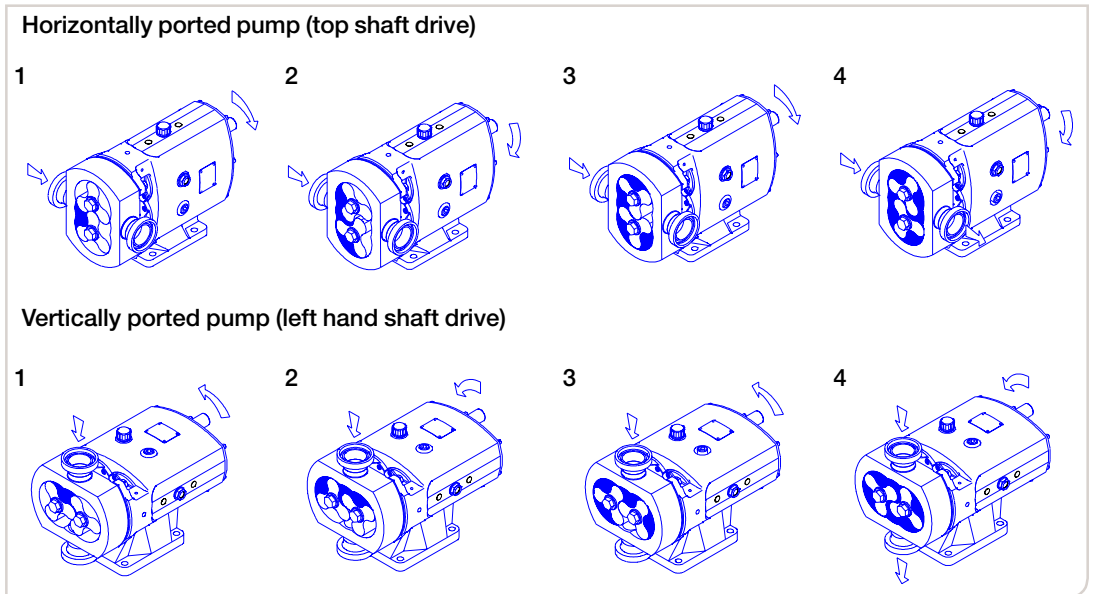

Fig. 4.3.2a Principle of operation

4.3.3 Pump Range

Alfa Laval Rotary Lobe Pumps can be supplied bare shaft (without drive) or complete with drive such as electric motor, air motor, and diesel or petrol engine (see 8.2.7). Ranges primarily as follows:



Fig. 4.3.3a SRU

SRU Range

The SRU pump range has been designed for use on general transfer duties throughout the brewing, dairy, food and chemical manufacturing processes.

The SRU range is available in six series each having two pumphead displacements and two different shaft materials.

- Displacement is the theoretical amount of fluid the pump will transfer per revolution.
- Duplex stainless steel material used for higher pressures.

Pump Description

The SRU pump range incorporates a universally mounted gearbox on series 1 - 4. This gives the flexibility of mounting pumps with the inlet and outlet ports in either a vertical or horizontal plane by changing the foot and foot position. For the larger series 5 and 6, either horizontal or vertical plane inlet and outlet porting is achieved by using dedicated gearbox castings. This pump range also incorporates full bore through porting complying with international standards BS4825/ISO2037, maximising inlet and outlet port efficiency and NPSH characteristics.

Flow rates up to 106 m³/h (466 US gall/min) and pressures up to 20 bar (290 psig).

The SRU range conforms to USA 3A requirements.

Pump Nomenclature

SRU Series	Build Selection			SRU Model	Displacement			Differential Pressure		Max. Speed
	Pump head code	Gearbox	Shaft		Litres/rev	UK gall/100 rev	US gall/100 rev	bar	psig	
1	005	L or H	D	SRU1/005/LD or HD	0.053	1.17	1.4	8	115	1000
	008	L or H	D	SRU1/008/LD or HD	0.085	1.87	2.25	5	75	1000
2	013	L or H	S	SRU2/013/LS or HS	0.128	2.82	3.38	10	145	1000
	013	L or H	D	SRU2/013/LD or HD	0.128	2.82	3.38	15	215	1000
	018	L or H	S	SRU2/018/LS or HS	0.181	3.98	4.78	7	100	1000
	018	L or H	D	SRU2/018/LD or HD	0.181	3.98	4.78	10	145	1000
3	027	L or H	S	SRU3/027/LS or HS	0.266	5.85	7.03	10	145	1000
	027	L or H	D	SRU3/027/LD or HD	0.266	5.85	7.03	15	215	1000
	038	L or H	S	SRU3/038/LS or HS	0.384	8.45	10.15	7	100	1000
	038	L or H	D	SRU3/038/LD or HD	0.384	8.45	10.15	10	145	1000
4	055	L or H	S	SRU4/055/LS or HS	0.554	12.19	14.64	10	145	1000
	055	L or H	D	SRU4/055/LD or HD	0.554	12.19	14.64	20	290	1000
	079	L or H	S	SRU4/079/LS or HS	0.79	17.38	20.87	7	100	1000
	079	L or H	D	SRU4/079/LD or HD	0.79	17.38	20.87	15	215	1000
5	116	L or H	S	SRU5/116/LS or HS	1.16	25.52	30.65	10	145	600
	116	L or H	D	SRU5/116/LD or HD	1.16	25.52	30.65	20	290	600
	168	L or H	S	SRU5/168/LS or HS	1.68	36.95	44.39	7	100	600
	168	L or H	D	SRU5/168/LD or HD	1.68	36.95	44.39	15	215	600
6	260	L or H	S	SRU6/260/LS or HS	2.60	57.20	68.70	10	145	500
	260	L or H	D	SRU6/260/LD or HD	2.60	57.20	68.70	20	290	500
	353	L or H	S	SRU6/353/LS or HS	3.53	77.65	93.26	7	100	500
	353	L or H	D	SRU6/353/LD or HD	3.53	77.65	93.26	15	215	500
L - Horizontal Porting H - Vertical Porting S - Stainless Steel D - Duplex Stainless Steel										

Table 4.3.3a



Fig. 4.3.3b SX

SX Range

The SX pump range is designed to be used where ultra-clean operation is critical, suited to applications in the pharmaceutical, biotechnology, fine chemical and speciality food industries. This pump range like the SRU range incorporates a universally mounted gearbox on series 1 - 4. This gives the flexibility of mounting pumps with the inlet and outlet ports in either a vertical or horizontal plane by changing the foot and foot position. For the larger series 5, 6 and 7, only vertical plane inlet and outlet porting is available by using a dedicated gearbox casting. This pump range also incorporates full bore through porting complying with international standards BS4825/ISO2037, maximising the inlet and outlet efficiency of the pump and the NPSH characteristics.

The SX range has been certified by EHEDG (European Hygienic Equipment Design Group) as fully CIP cleanable to their protocol. In addition to being EHEDG compliant, the SX pump also conforms to the USA 3A standard and all media contacting components are FDA compliant. All media contacting elastomers are controlled compression joints to prevent pumped media leaking to atmosphere (see section 6.2).

The SX range is available in seven series each having two pumphead displacements. Flow rates up to 115 m³/h (506 US gall/min) and pressures up to 15 bar (215 psig).

Pump Nomenclature

SX Series	Build Selection		SX Model	Displacement			Differential Pressure		Max. Speed rev/min
	Pump head code	Gearbox		Litres/rev	UK gall/100 rev	US gall/100 rev	bar	psig	
1	005	H or U	SX1/005/H or U	0.05	1.11	1.32	12	175	1400
	007	H or U	SX1/007/H or U	0.07	1.54	1.85	7	100	1400
2	013	H or U	SX2/013/H or U	0.128	2.82	3.38	15	215	1000
	018	H or U	SX2/018/H or U	0.181	3.98	4.78	7	100	1000
3	027	H or U	SX3/027/H or U	0.266	5.85	7.03	15	215	1000
	035	H or U	SX3/035/H or U	0.35	7.70	9.25	7	100	1000
4	046	H or U	SX4/046/H or U	0.46	10.12	12.15	15	215	1000
	063	H or U	SX4/063/H or U	0.63	13.86	16.65	10	145	1000
5	082	H	SX5/082/H	0.82	18.04	21.67	15	215	600
	115	H	SX5/115/H	1.15	25.30	30.38	10	145	600
6	140	H	SX6/140/H	1.40	30.80	36.99	15	215	500
	190	H	SX6/190/H	1.90	41.80	50.20	10	145	500
7	250	H	SX7/250/H	2.50	55.00	66.05	15	215	500
	380	H	SX7/380/H	3.80	83.60	100.40	10	145	500

H - Vertical Port (EHEDG approved)
U - Universal mounting (not EHEDG approved)

Table 4.3.3b

5. Pump Materials of Construction

This section describes the materials, both metallic and elastomeric, that are used in the construction of Alfa Laval pump ranges.

5.1 Main Components

Pumps today can be manufactured from a number of different materials dependent upon the product being pumped and its environment.

For Alfa Laval pump ranges this is generally stainless steel and can be split into two main categories:

- Product Wetted Parts
(i.e. Metallic and elastomeric parts in contact with the fluid being pumped).
- Non-product Wetted Parts
(i.e. Metallic and elastomeric parts not in contact with the fluid being pumped).

Centrifugal and Liquid Ring Pumps

Main Pump Component	Product Wetted Parts	Non-product Wetted Parts
Adaptor		AISI 304 or Werkstoff 1.4301
Backplate	AISI 316L or Werkstoff 1.4404	
Impeller	AISI 316L or Werkstoff 1.4404	
Pump Casing	AISI 316L or Werkstoff 1.4404	
Pump Shaft	AISI 316L or Werkstoff 1.4404	
Shroud and Legs		AISI 304 or Werkstoff 1.4301

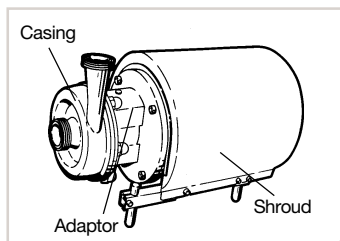

Fig. 5.1a Centrifugal pump

Table 5.1a

Rotary lobe pumps

Main Pump Component	SRU Models		SX Models	
	Metallic Product Wetted Parts	Metallic Non-product Wetted Parts	Metallic Product Wetted Parts	Metallic Non-product Wetted Parts
Gearcase		BS EN 1561:1977 grade 250 cast iron		BS EN 1561:1977 grade 250 cast iron
Rotor	Werkstoff 1.4404 or 316L, Non-galling alloy or rubber covered		BS EN 10088-3:1995 grade 1.4404 or 316L	
Rotorcase	BS 3100:1991 316 C12 or 316L		BS3100:1991 316 C12 or 316L or BS EN10088-3:1995 grade 1.4404	
Rotorcase Cover	BS3100:1991 316 C12 or 316L or BS EN10088-3:1995 grade 1.4404		BS3100:1991 316 C12 or 316L or BS EN10088-3:1995 grade 1.4404	
Shaft	BS EN10088-3:1995 grade 1.4404 or 316L or duplex stainless steel (AISI 329 or BS EN10088-3:1995 grade 1.4462)		Duplex stainless steel (AISI 329 or BS EN10088-3:1995 grade 1.4462)	

Table 5.1b

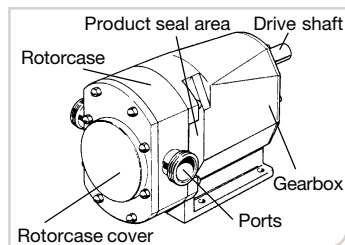

Fig. 5.1b Rotary lobe pump

For description of elastomers used see 5.3.

For mechanical seal components see 6.1.

Surface finish of product wetted steel components has become a major factor in the food, pharmaceutical and biotechnology industries where hygiene and cleanability are of paramount importance.

5.2 Steel Surfaces

The 'standard' machined surface finish on pumps can be enhanced by the following methods:

- Rumbling.
- Shot blasting.
- Electropolishing.
- Mechanical (Hand) polishing.

Rumbling

This is achieved by vibrating the pump components with abrasive particulate such as stones and steel balls.

Shotblasting

This method involves blasting finished components with small metallic particles at great force to achieve the surface finish required. For Alfa Laval centrifugal stainless steel pump components, fine particles of stainless steel are used in this process to avoid contamination.

Electropolishing

This is an electro-chemical process in which the stainless steel component is immersed into a chemical bath and subjected to an electrical current. A controlled amount of metal is removed from all surfaces evenly. The appearance is 'Semi bright'.

Mechanical (Hand)

This is required when it is necessary to improve the surface finish beyond that achieved by electropolishing only i.e. a 'Mirror finish'.

It typically involves:

- Fine grinding using felt and compound.
- Brushing using bristle brushes and compound to remove any cutting marks left from fine grinding, and to reach any awkward areas.
- Polishing using mops and compound to obtain a mirror polished effect.

Surface Roughness

The most commonly used surface roughness measurement is Ra and is defined as ‘the arithmetic mean of the absolute value of the departure of the profile from the mean line’. Ra is measured in micron (μm). The surface roughness can alternatively be specified by a Grit value. The Grit value specifies the grain size of the coating of the grinding tool used.

The approximate connection between the Ra value and the Grit value is as follows:

$Ra = 0.8 \mu\text{m}$ ($32 Ra$) \approx 150 Grit (3A standard).

$Ra = 1.6 \mu\text{m}$ ($64 Ra$) \approx 100 Grit.

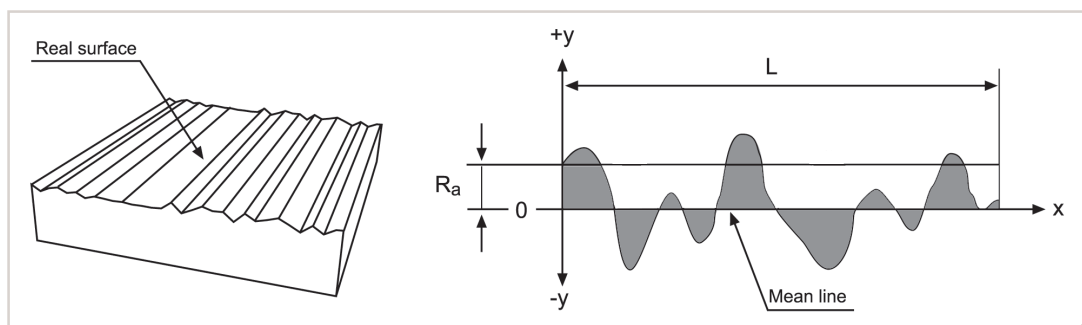

Fig. 5.2a Surface roughness

For Alfa Laval Centrifugal and Liquid Ring Pumps see table below:

Pump surfaces	Standard surface roughness Ra (mm) by Rumbling method	Optional surface roughness (3A finish) Ra (mm) by Mechanical (Hand) method	Optional surface roughness (3A finish) Ra (mm) by shot blasting (Hand or Electropolished)
Product wetted surfaces	< 1.6 (<i>64 Ra</i>)	< 0.8 (<i>32 Ra</i>)	< 0.5 (<i>20 Ra</i>)
External exposed surfaces	< 1.6 (<i>64 Ra</i>)	< 1.6 (<i>64 Ra</i>)	< 1.6 (<i>64 Ra</i>)
Cast surfaces	< 3.2 (<i>125 Ra</i>)	\leq 3.2 (<i>125 Ra</i>)	\leq 3.2 (<i>125 Ra</i>)
Other surfaces	\leq 6.3 (<i>250 Ra</i>)	\leq 6.3 (<i>250 Ra</i>)	\leq 6.3 (<i>250 Ra</i>)

Table 5.2a

Alfa Laval Centrifugal and Liquid Ring pumps supplied in the USA have all product wetted surfaces and external exposed surfaces to 0.8 Ra.

For Alfa Laval Stainless Steel Rotary Lobe Pumps the surface roughness on product wetted parts such as rotors, rotorcase, rotor nuts and rotorcase covers is as follows:

- ‘Standard’ - 0.8 Ra
- Electropolishing - 0.8 Ra
- Mechanical (Hand) - 0.5 Ra

5.3 Elastomers

Alfa Laval pump ranges incorporate elastomers of different material and characteristics dependent upon application within the pump and the fluid being pumped.

Various elastomer types are specified below. It is difficult to predict the lifetime of elastomers as they will be affected by many factors, e.g. chemical attack, temperature, mechanical wear etc.

A selection guide is shown in section 14.10.

NBR (Nitrile)

- Available as O-rings or Quad-rings (depending on pump type).
- Used as static or dynamic seals.
- Resistant to most hydrocarbons, e.g. oil and grease.
- Sufficiently resistant to diluted lye and diluted nitric acid.
- Temperature range - minus 40°C min to 100°C max. (*minus 40°F to 212°F max.*).
- Is attacked by ozone.

EPDM (Ethylene Propylene)

- Available as O-rings or Quad-rings (depending on pump type).
- Used as static or dynamic seals.
- Resistant to most products used within the food industry.
- Resistant to ozone and radiation.
- Temperature range - minus 40°C min to 150°C max. (*minus 40°F to 302°F max.*).
- Not resistant to organic and non-organic oils and fats.

FPM (Fluorinated rubber)

- **alternatively known as Viton®**

- Available as O-rings or Quad-rings (depending on pump type).
- Used as static or dynamic seals.
- Often used when other rubber qualities are unsuitable.
- Resistant to most chemicals and ozone.
- Temperature range - minus 20°C min to 200°C max. (*minus 4°F to 392°F max.*).
- Not suitable for fluids such as water, steam, lye, acid and alcohol's being pumped hot.

PTFE (Polytetrafluoro Ethylene)

- Can be used as “cover” for O-ring seals of EPDM (i.e. encapsulated).
- Used as static or dynamic seals.
- Resistant to ozone.
- Resistant to almost all products.
- Temperature range - minus 30°C min to 200°C max. (*minus 22°F to 392°F max.*).
- Not elastic, tendency to compression set.

MVQ (Silicone)

- Used as static or dynamic seals.
- Resistant to ozone, alcohol's, glycol's and most products used within food industry.
- Temperature range - minus 50°C min to 230°C max. (*minus 58°F to 446°F max.*).
- Not resistant to steam, inorganic acids, mineral oils, or most organic solvents.

FEP (Fluorinated Ethylene Propylene)

- FEP covered (vulcanised) FPM or MVQ O-rings.
- Used as static or dynamic seals.
- Resistant to ozone.
- Resistant to almost all products.
- Suitable for temperatures up to approx. 200°C (392°F).
- More elastic than PTFE covered EPDM.

Kalrez® (Perfluoroelastomer)

- Used as static or dynamic seals.
- Resistant to ozone.
- Resistant to almost all products.
- Temperature range – minus 20°C min to 250°C max. (*minus 4°F to 482°F max.*).
- Elastic.

Chemraz® (Perfluoroelastomer)

- Used as static or dynamic seals.
- Resistant to ozone.
- Resistant to almost all products.
- Temperature range – minus 30°C min to 250°C max. (*minus 22°F to 482°F max.*).
- Elastic.

6. Pump Sealing

This section describes the principle of pump sealing and illustrates the different sealing arrangements used on Alfa Laval pump ranges. A general seal selection guide is included, together with various operating parameters.

This section covers the shaft sealing devices used on Alfa Laval Centrifugal, Liquid Ring and Rotary Lobe Pumps. In addition to shaft seals, other proprietary seals not detailed in this section, such as 'o' rings and lip seals can be found on the pumphead and gearcase.

“A Pump is only as good as it's shaft seal”

A successful pump application largely depends upon the selection and application of suitable fluid sealing devices. Just as we know that there is no single pump that can embrace the diverse range of fluids and applications whilst meeting individual market requirements and legislations, the same can be said of fluid sealing devices. This is clearly illustrated by the large range of shaft seal arrangements, both mechanical and packed gland, that are available to the pump manufacturer.

Shaft sealing devices used in Alfa Laval Centrifugal, Liquid Ring and Rotary Lobe pumps include:

- Mechanical Seals (see 6.2).
 - Single externally mounted.
 - Single internally mounted.
 - Single externally mounted for external flush.
 - Single internally mounted for product recirculation or external flush.
 - Double 'back to back' with the inboard seal externally mounted for flush.

- Packed Glands (see 6.3).
 - Both with and without lantern rings for flush.

Centrifugal and Liquid Ring pumps only have one shaft seal whereas Rotary Lobe pumps employ a minimum of two shaft seals (one per shaft). Generally all shaft seals are under pressure with the pressure gradient across the seal being from pumped fluid to atmosphere. The exceptions will be single internally mounted or double seals where the product recirculation (single internally mounted only) or flush pressure is greater than the pump pressure, resulting in the pressure gradient being reversed.

Mechanical seals meet the majority of application demands and of these, single and single flushed seals are most frequently specified. The application of double mechanical seals is increasing to meet both process demands for higher sanitary standards and legislation requirements, particularly those related to emissions.

The majority of proprietary mechanical seals available from seal manufacturers have been designed for single shaft pump concepts, such as Centrifugal and Liquid Ring pumps. These pump types do not impose any radial or axial constraints on seal design. However on Rotary Lobe type pumps the need to minimise the shaft extension beyond the front bearing places significant axial constraints. If this were extended, the shaft diameter would increase introducing a radial constraint - because shafts on a rotary lobe pump are in the same plane, the maximum diameter of the seal must be less than the shaft centres. Most designs therefore can only accommodate 'bespoke' or 'customised' seal design. This is not done to take any commercial advantage but it is as a consequence of the rotary lobe pump design concept.

There is often more than one solution and sometimes no ideal solution, therefore a compromise may have to be considered.

Selection of shaft seals is influenced by many variables:

- Shaft diameter and speed
- Fluid to be pumped
 - Temperature
 - effect on materials?
 - can interface film be maintained?
 - Viscosity
 - drag on seal faces?
 - clogging of seal restricting movement?
 - can interface film be established and maintained?
 - Fluid behaviour
 - stiction at seal faces?
 - does product shear, thin, thicken or 'work' - balling/carbonise?
 - can interface film be established and maintained?
 - Solids
 - size?
 - abrasiveness?
 - density?
 - clogging of seal restricting movement?
 - can interface film be established and maintained?
 - Thermal stability
 - what, if any change?
 - Air reacting
 - what, if any change?
- Pressure
 - within seal limits?
 - fluctuations?
 - peaks/spikes?
 - cavitation?
- Services
 - flush?
 - pressure?
 - temperature?
 - continuity?
- Health and Safety
 - toxic?
 - flammable?
 - explosive?
 - corrosive?
 - irritant?
 - carcinogenic?

6.1 Mechanical Seals - General

Mechanical seals are designed for minimal leakage and represent the majority of Centrifugal, Liquid Ring and Rotary Lobe pump sealing arrangements.

Mechanical seal selection must consider:

- The materials of seal construction, particularly the sealing faces and elastomers.
- The mounting attitude to provide the most favourable environment for the seal.
- The geometry within which it is to be mounted.

A mechanical seal typically comprises of:

- A primary seal, comprising of stationary and rotary seal rings.
- Two secondary seals, one for each of the stationary and rotary seal rings.
- A method of preventing the stationary seal ring from rotating.
- A method of keeping the stationary and rotary seal rings together when they are not hydraulically loaded i.e. when pump is stopped.
- A method of fixing and maintaining the working length.

The Primary Seal

Comprises of two flat faces, one rotating and one stationary, which support a fluid film, thus minimising heat generation and subsequent mechanical damage.

Commonly used material combinations are:

Carbon	-	Stainless Steel
Carbon	-	Silicon Carbide
Carbon	-	Tungsten Carbide
Silicon Carbide	-	Silicon Carbide
Tungsten Carbide	-	Tungsten Carbide

The Secondary Seal

This is required to provide a seal between the primary seal rings and the components with which they interface. Also it can provide a cushion mounting for the seat ring to reduce any effects of mechanical stress i.e. shock loads.

Types of secondary seal are:

- 'O' rings
- Cups
- Gaskets
- Wedges

For Alfa Laval pump ranges the 'O' ring is the most commonly type of secondary seal used. It's simple and versatile concept is enhanced with the following comprehensive material options:

- NBR
- EPDM
- FPM
- PTFE
- MVQ
- FEP
- Kalrez®
- Chemraz®

These are fully described in section 5.3.

Mechanical Seal Face/'O' Ring Material Availability

Pump Type	Pump Range	Rotary Seal Face				Stationary Seal Face				Seal 'O' Ring					
		Carbon	Stainless Steel	Silicon Carbide	Tungsten Carbide	Carbon	Stainless Steel	Silicon Carbide	Tungsten Carbide	NBR	EPDM	FPM	PTFE	MVQ	FEP
Centrifugal/ Liquid ring	LKH	✓		✓				✓		✓	✓	✓			✓
	LKH-Multistage	✓		✓				✓		✓	✓	✓			✓
	LKHHP-High Pressure			✓				✓		✓	✓	✓			✓
	LKHSP	✓						✓		✓	✓	✓			✓
	LKHI	✓		✓				✓		✓	✓	✓			✓
	LKH-Ultra Pure MR	✓	✓	✓		✓	✓	✓		✓	✓	✓			✓
Rotary Lobe	SRU SX (see note)	✓	✓	✓	✓	✓		✓	✓	✓	✓	✓		✓	

Note: SX1 pump has tungsten carbide seal faces, not silicon carbide seal faces.

Table 6.1a

Stationary Seal Ring Anti-Rotation

Ideally the selected device listed below will also allow for axial resilience.

- Flats
- Pins
- Elastomer resilience
- Press fit
- Clamps

Rotary Seal Ring Drive

Ideally the selected device listed below will allow for a degree of axial movement.

- Spring
- Bellows
- Physical positioning
- Elastomer resilience

One of the main causes of seal failure is for the seal working length not being correctly maintained.

Fig. 6.1a Typical single mechanical seal used in rotary lobe pumps

Working Length

The ideal design should eliminate/minimise possibilities for error by incorporating:

- Physical position i.e. step on shaft
- Grub screws

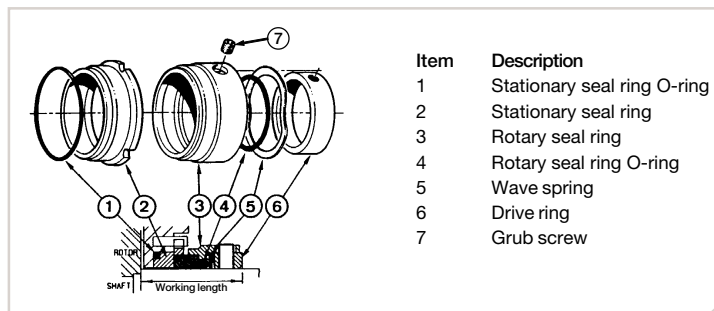

Fig. 6.1b Typical single mechanical seal used in centrifugal pumps

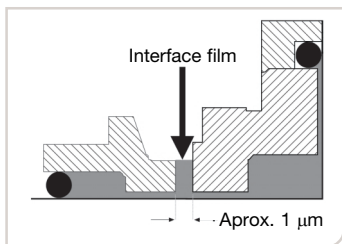
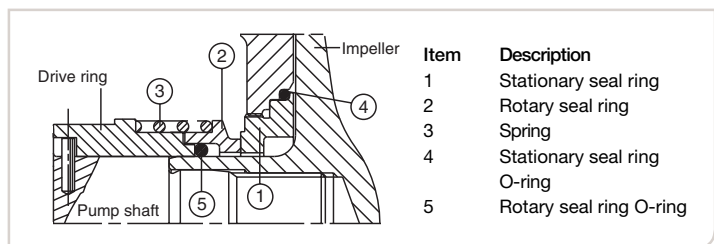
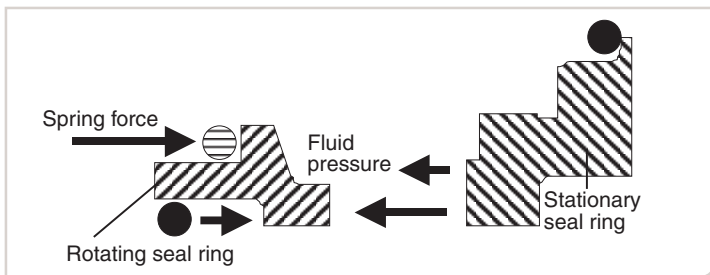

Fig. 6.1c Principle of mechanical seal operation

Principle of Mechanical Seal Operation

The function of the assembly is a combination of the extreme primary seal face flatness and applied spring force. Once the pump is operational, hydraulic fluid forces combine with seal design features i.e. balance, which push the seal faces together. This reduces the fluid interface thickness to a minimum whilst increasing pressure drop, therefore minimising pumped fluid leakage.

Fig. 6.1d Principle of mechanical seal operation



The gap between the seal ring surfaces is enlarged to clarify the principle of mechanical sealing.

Mechanical Seal Mounting

Most mechanical seals can be mounted externally or internally.

External Mechanical Seals

The majority of mechanical seals used on Alfa Laval pump ranges are mounted externally, meaning that all the rotating parts of the mechanical seal (i.e. part of the rotary seal ring, spring, drive ring etc) are not in contact with the fluid to be pumped. The externally mounted mechanical seal is considered easy to clean, as only the inside of the stationary and rotary seal rings and there associated 'o' rings are in contact with the fluid being pumped. The R00 type mechanical seals used on the SX rotary lobe pump range, described in 6.2, are an exception to this, as it is the outside and not the inside of the seal components that is in contact with the fluid being pumped. Externally mounted seals have a lower pressure rating than the equivalent seal mounted internally.

Fig. 6.1e Typical external shaft seal

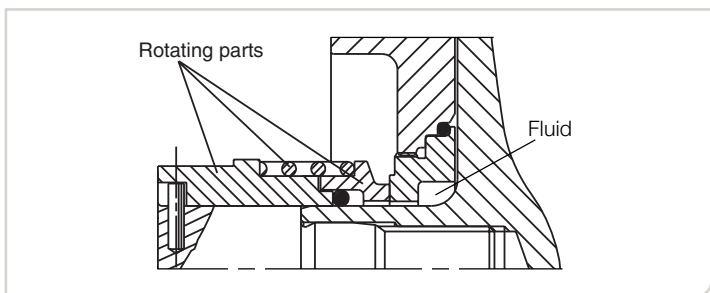

Internal Mechanical Seals

Some mechanical seals are mounted internally, meaning that most of the rotating parts are in contact with the fluid being pumped. The internal mechanical seal is designed with sufficient clearance around the rotating parts so that it can be cleaned as efficiently as possible and can withstand relatively high fluid pressures.

Fig. 6.1f Typical internal shaft seal

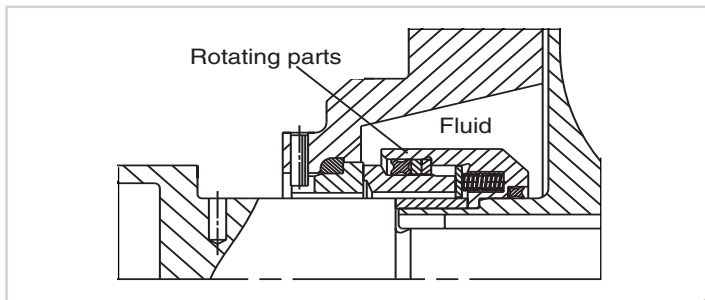

For the Alfa Laval pump ranges, both the externally and internally mounted types of mechanical seal are available as single and single flushed versions. The externally mounted mechanical seal on Alfa Laval pump ranges is also available as a double flushed mechanical seal for some pump models. The typical single, single flushed and double flushed mechanical seal arrangements are described as follows:

Single Mechanical Seal

This is the simplest shaft seal version, which has already been described previously in this section. This seal arrangement is generally used for fluids that do not solidify or crystallise in contact with the atmosphere and other non-hazardous duties. For satisfactory operation it is imperative the seal is not subjected to pressures exceeding the maximum rated pressure of the pump. Also the pump must not be allowed to run 'dry', thus avoiding damage to the seal faces, which may cause excessive seal leakage.

Typical applications are listed below, but full product/fluid and performance data must be referred to the seal supplier for verification.

- Alcohol • Animal Fat • Aviation Fuel • Beer • Dairy Creams
- Fish Oil • Fruit Juice • Liquid Egg • Milk • Shampoo
- Solvents • Vegetable Oil • Water • Yoghurt

Single Flushed Mechanical Seal

The definition of 'flush' is to provide a liquid barrier or support to the selected seal arrangement. This seal arrangement is generally used for any of the following conditions:

- where the fluid being pumped can coagulate, solidify or crystallise when in contact with the atmosphere.
- when cooling of the seals is necessary dependent upon the fluid pumping temperature.

This seal arrangement used on externally mounted seals requires the supply of liquid to the atmospheric side of the mechanical seal to flush the seal area. The characteristics of the fluid being pumped and the duty conditions will normally determine if a flush is necessary. When selecting a flushing liquid you must ensure that it is chemically compatible with the relevant materials of pump/seal construction and fully compatible with the fluid being pumped. Consideration should be given to any temperature limitations that may apply to the flushing liquid to ensure that hazards are not created (i.e. explosion, fire, etc). The flushing liquid is allowed to enter the seal housing at low pressure i.e. 0.5 bar max (7 *psi max*) to act as a barrier.

This most basic flush system, sometimes referred to as quench, provides liquid to the atmosphere side of the mechanical seal thereby flushing away any product leakage. For the majority of pump models the flushed seal comprises of the same stationary and rotating parts as the single seal, with the addition of a seal housing having a flushing connection and/or flushing tubes and a lip seal.

Fig. 6.1g Typical externally mounted single flushed mechanical seal used in rotary lobe pumps

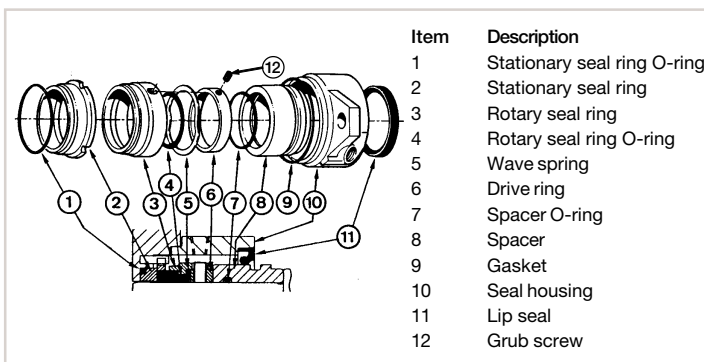
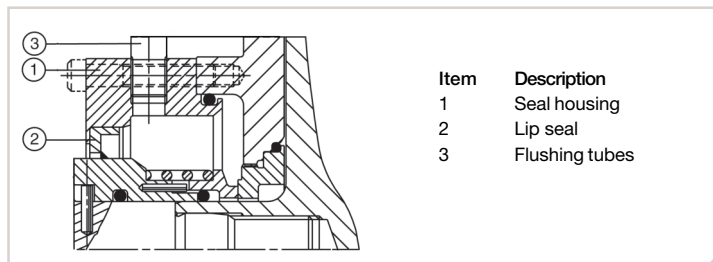

Fig. 6.1h Typical externally mounted single flushed mechanical seal used in centrifugal pumps



Typical applications are listed below, but full product/fluid and performance data must be referred to the seal supplier for verification.

- Adhesive • Caramel • Detergent • Fruit Juice Concentrate • Gelatine
- Jam • Latex • Paint • Sugar Syrup • Toothpaste • Yeast

Double Flushed Mechanical Seal

This seal arrangement is generally used with hostile media conditions i.e. high viscosity, fluid is hazardous or toxic. The double flushed seal used on Alfa Laval pump ranges is basically two single mechanical seals mounted 'back to back'. This seal generally comprises of the same stationary and rotating parts as the single seal for the majority of pump models, with the addition of a seal housing having a flushing connection and/or flushing tubes (dependent upon pump type). A compatible flushing liquid is pressurised into the seal housing at a pressure of 1 bar (14 psi) minimum above the discharge pressure of the pump. This results in the interface film being the flushing liquid and not the pumped liquid. Special attention is required in selecting seal faces and elastomers.

The arrangement in contact with the pumped fluid is referred to as the 'inboard seal', and the seal employed for the flushing liquid is referred to as the 'outboard seal'. For Alfa Laval Centrifugal pumps the design of the outboard seal differs to the inboard seal.

Fig. 6.1i Typical double flushed mechanical seal used in rotary lobe pumps

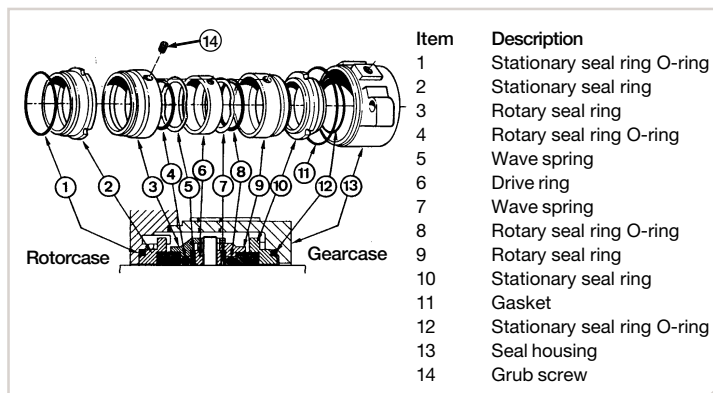
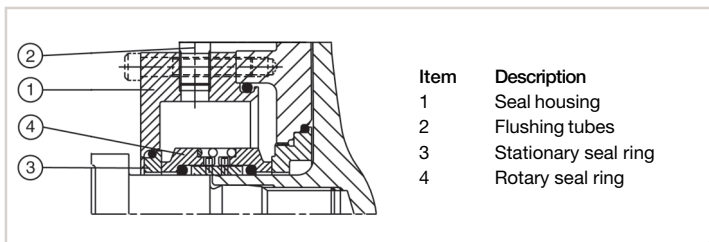

Fig. 6.1j Typical double flushed mechanical seal used in centrifugal pumps



Typical applications are listed below, but full product/fluid and performance data must be referred to the seal supplier for verification.

- Abrasive Slurries • Chocolate • Glucose • Hazardous Chemicals
- PVC Paste • Photographic Emulsion • Resin

General Seal Face Operating Parameters

Tables below show general parameters regarding viscosity and temperature, which should be noted when selecting a mechanical seal.

Table 6.1b

Viscosity	Seal Face Combination
up to 4999 cP	Solid Carbon v Stainless Steel Solid Carbon v Silicon Carbide Solid Carbon v Tungsten Carbide
up to 24999 cP	Inserted Carbon v Stainless Steel Inserted Carbon v Silicon Carbide Inserted Carbon v Tungsten Carbide
up to 149999 cP	Silicon Carbide v Silicon Carbide Tungsten Carbide v Tungsten Carbide
above 150000 cP	Consider Double Seals

Table 6.1c

Temperature	Seal Face Combination
up to 150°C (302°F)	Inserted Carbon v Stainless Steel Inserted Carbon v Silicon Carbide Inserted Carbon v Tungsten Carbide Silicon Carbide v Silicon Carbide Tungsten Carbide v Tungsten Carbide
up to 200°C (392°F)	Solid Carbon v Stainless Steel Inserted Carbon v Silicon Carbide Inserted Carbon v Tungsten Carbide

Flushing Pipework Layout

The suggested arrangement below is for single mechanical seals only. If the pump is fitted with double mechanical seals or packed glands the pressure gauges and control valves should be fitted on the outlet side of the system. The choice of flushing liquid is dependent upon compatibility with the pumping media and overall duty conditions i.e. pressure and temperature. Usually water is used for cooling and any water soluble products.

Fig. 6.1k Typical flushing pipework layout for a rotary lobe pump

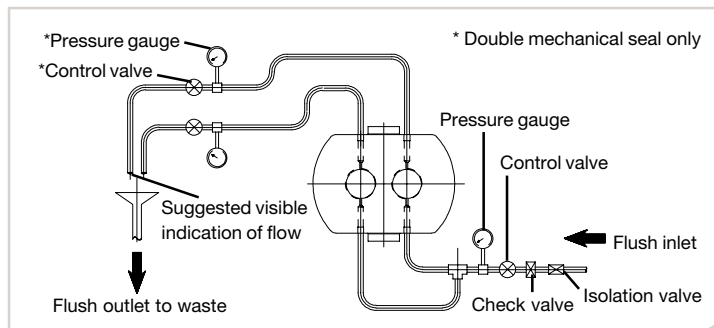
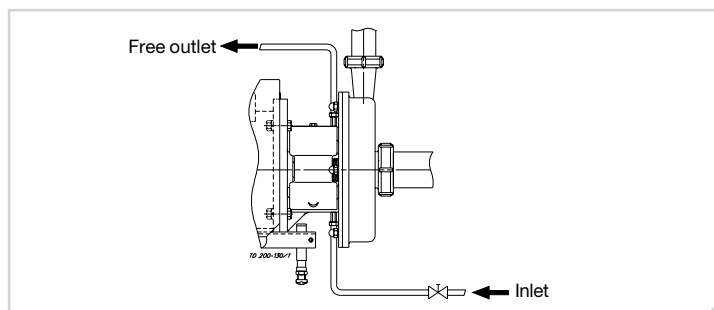

Fig. 6.1l Typical flushing pipework layout for a centrifugal pump



Mechanical Seal Selection Process

The illustration below describes the mechanical seal selection process with relevant questions to be answered.

Fig. 6.1m Seal selection process

This should be used for guidance purposes only, as actual seal selections should be verified by the seal suppliers.

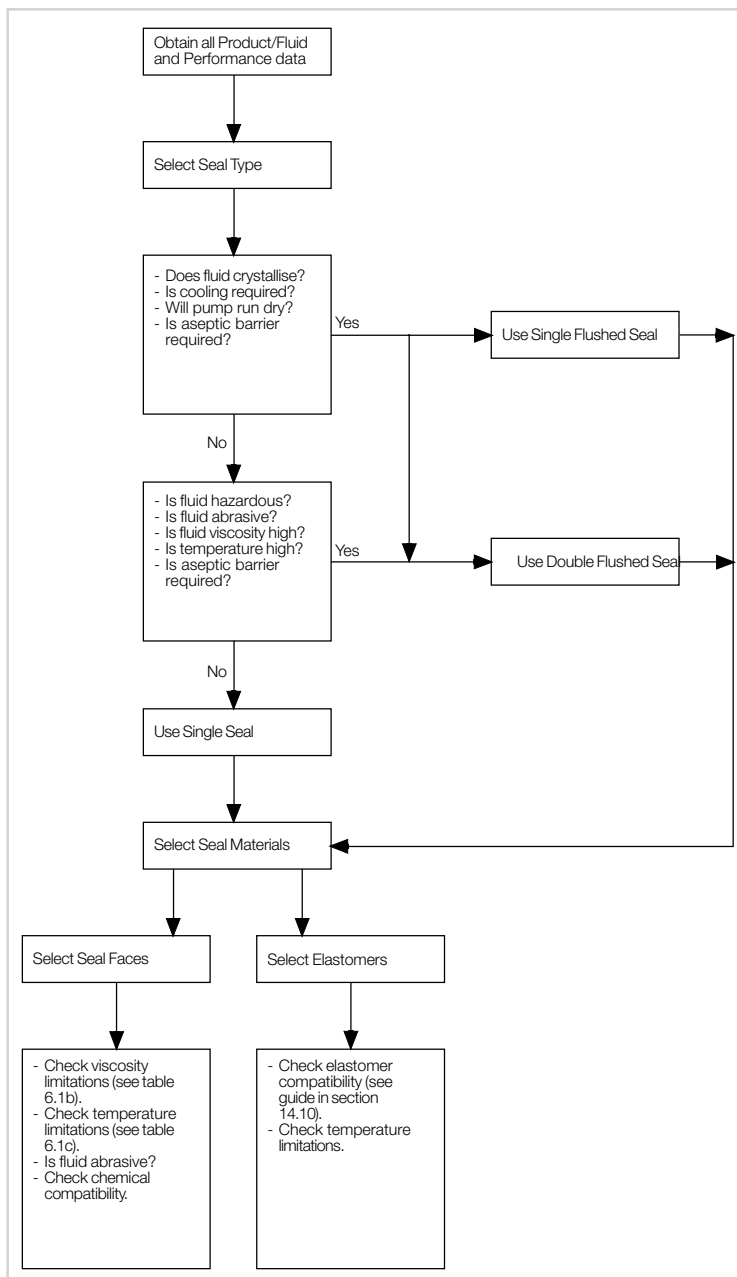

6.2 Mechanical Seal Types in Alfa Laval Pump Ranges

Seal Option Availability for Centrifugal and Liquid Ring Pumps

Pump Range	External Mounting			Internal Mounting	
	Single	Single Flushed	Double Flushed	Single	Single Flushed
LKH	✓	✓	✓		
LKH-Multistage				✓	✓
LKHP				✓	✓
LKHSP	✓	✓	✓		
LKHI				✓	✓
LKH-UltraPure	✓		✓		
MR-166S, -200S	✓				
MR-300				✓	

Table 6.2a

Seal Option Availability for Rotary Lobe Pumps

Table 6.2b

Mechanical Seal Type	Seal Name	Pump Range	
		SRU	SX
Single externally mounted	R90	✓	
	R00		✓
	Hyclean	✓	
Single flushed externally mounted	R90	✓	
	R00		✓
	Hyclean	✓	
Single flushed internally mounted	R90	✓	
Double flushed	R90	✓	
	R00		✓

R90 Type Mechanical Seals

The basic working principles of the R90 type mechanical seals have previously been referred to in 6.1.

Hyclean Type Mechanical Seals

This seal arrangement is generally used for food and other hygienic applications. The design of this seal incorporates a self-cleaning feature.

Fig. 6.2a Hyclean single mechanical seal

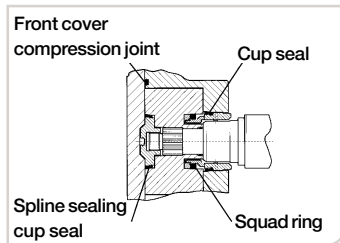
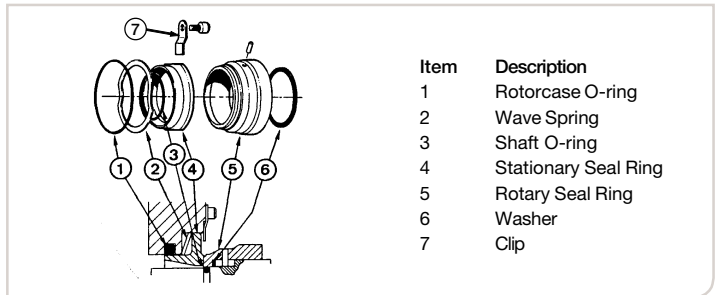
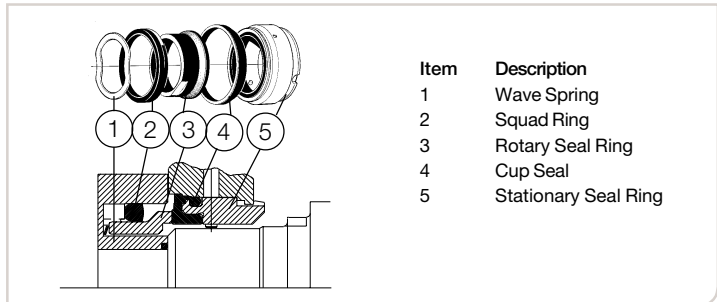

Fig. 6.2b SX pumphead sealing

R00 Type Mechanical Seals

The R00 type mechanical seals specifically designed for the SX rotary lobe pump range are fully front loading seals and fully interchangeable without the need for additional housings or pump component changes. Specialised seal setting of the mechanical seal is not required as the seal is dimensionally set on assembly. Seal faces positioned in the fluid area minimise shear forces. All seals have controlled compression joint elastomers at fluid/atmosphere interfaces.

Fig. 6.2c R00 single mechanical seal



6.3 Other Sealing Options (Rotary Lobe Pumps only)

This is a simple, low cost, and easy to maintain controlled leakage sealing arrangement. These are specified for many ‘dirty’ applications, but when possible, should always be avoided for sanitary duties, as they are less hygienic than mechanical seals.

Packed Gland

The grade of packing used depends on the product being handled and operating conditions. When packed glands are specified, using polyamide or PTFE packings will satisfy the majority of duties. Provided the liquid being sealed contains no abrasive particles or does not crystallise, gland packings will function satisfactorily on plain stainless steel shafts or renewable stainless steel shaft sleeves. In instances of moderately abrasive fluids, such as brine solutions being handled, the pumps should be fitted with hard coated shaft sleeves, which may be easily replaced when worn. Pumps provided with a packed gland seal are normally fitted with rubber slingers mounted between the gland followers and the gearcase front lip seals. The slingers will reduce the possibility of the product contacting the gearcase lip seals, thereby overcoming any undesirable operating conditions that could arise in this area. When correctly assembled and adjusted, a slight loss of product should occur so as to lubricate the packing and shaft or sleeve, if fitted.

Fig. 6.3a Packed gland

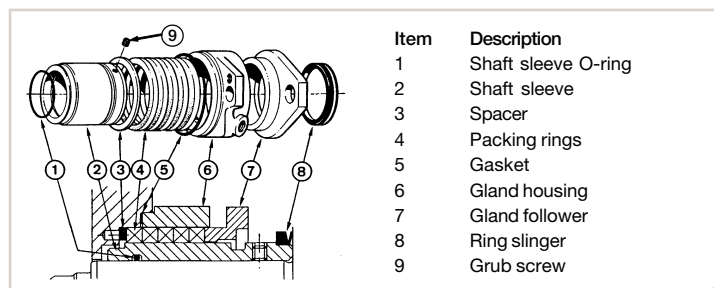

This seal arrangement is available on all SRU pump models.

Packed Gland with Lantern Ring

With fluids containing very abrasive particles or fluids that will coagulate, solidify or crystallise in contact with the atmosphere, a packed gland with lantern ring may be used. In such circumstances a compatible liquid is supplied to the chamber formed by the lantern ring at a pressure of at least 1 bar (14 psi) above the pump pressure. The function of this liquid is to prevent, or at least inhibit, the entry of abrasives into the very small clearances between the shaft and packing. In the case of liquids which coagulate, solidify or crystallise in contact with the atmosphere the flushing liquid acts as a dilutant and barrier in the gland area preventing the pumped fluid from coming in contact with the atmosphere.

A disadvantage with this seal arrangement is that the flushing liquid will pass into the product causing a relatively small degree of dilution/contamination, which cannot always be accepted.

In common with all packed gland assemblies slight leakage must occur but in this instance it will basically be a loss of flushing liquid as opposed to product being pumped.

Fig. 6.3b Packed gland with lantern ring

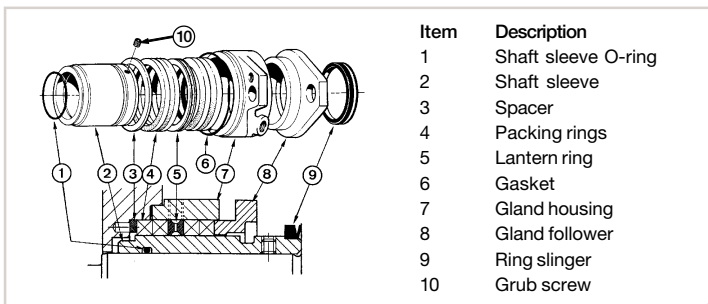

This seal arrangement is available on all SRU pump models.

7. Pump Sizing

This section shows how to size an Alfa Laval pump from product/fluid and performance data given, supported by relevant calculations and worked examples with a simple step by step approach.

See section 2 for detailed descriptions of Product/Fluid data and Performance data.

7.1 General Information Required

In order to correctly size any type of pump some essential information is required as follows:

Product/Fluid Data

- Fluid to be pumped.
- Viscosity.
- SG/Density.
- Pumping temperature.
- Vapour pressure.
- Solids content (max. size and concentration).
- Fluid behaviour (i.e. Newtonian or Pseudoplastic etc.).
- Is product hazardous or toxic?
- Does fluid crystallise in contact with atmosphere?
- Is CIP required?

Performance Data

- Capacity (Flow rate).
- Discharge head/pressure.
- Suction condition (flooded or suction lift).

Site Services Data

- Power source (electric, air, diesel, petrol or hydraulic).
If electric - motor enclosure and electrical supply.
- Seal flushing fluid.

In an ideal situation all the above criteria should be known before sizing a pump - however, in many instances not all of this information is known and made available. In such cases to complete the sizing process, some assumptions may need to be made based upon application knowledge, experience etc. These should be subsequently confirmed, as they could be critical to satisfactory installation and operation.

7.2 Power

All of the system energy requirements and the energy losses in the pump must be supplied by a prime mover in the form of mechanical energy. The rate of energy input needed is defined as power and is expressed in watts (W) - for practical purposes, power within this handbook is expressed in kilowatts (kW), i.e. watts x 10³.

7.2.1 Hydraulic Power

The theoretical energy required to pump a given quantity of fluid against a given total head is known as hydraulic power, hydraulic horse power or water horse power.

This can be calculated as follows:

$$\text{Hydraulic Power (W)} = Q \times H \times \rho \times g$$

where: Q = capacity (m³/s)
 H = total head/pressure (m)
 ρ = fluid density (kg/m³)
 g = acceleration due to gravity (m/s²)

Other forms of this equation can be as follows:

$$\text{Hydraulic Power (kW)} = \frac{Q \times H}{k}$$

where: Q = capacity
 H = total head/pressure
 k = constant (dependent upon units used)

Therefore

$$\text{Hydraulic Power (kW)} = \frac{Q \times H}{k}$$

where: Q = capacity (l/min)
 H = total head/pressure (bar)
 k = 600

or

$$\text{Hydraulic Power (hp)} = \frac{Q \times H}{k}$$

where: Q = capacity (US gall/min)
 H = total head/pressure (psi)
 k = 1715

or

$$\text{Hydraulic Power (hp)} = \frac{Q \times H}{k}$$

where: Q = capacity (UK gall/min)
 H = total head/pressure (psi)
 k = 1428

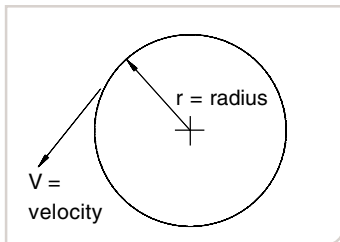

Fig. 7.2.2a Shaft angular viscosity

7.2.2 Required Power

The required power or brake horsepower is the power needed at the pump shaft. This is always higher than the hydraulic power due to energy losses in the pump mechanism (friction loss, pressure loss, seals etc) and is derived from:

$$\text{Required Power} = \omega \times T$$

where: ω = shaft angular velocity
 T = Shaft Torque

$$\text{Shaft angular velocity } \omega = V \times r$$

And is related to Hydraulic power by:

$$\text{Required Power} = \frac{\text{Hydraulic Power}}{\text{Efficiency (100\% = 1.0)}}$$

The appropriate prime mover power must be selected. Generally this will be the nearest prime mover rated output power above the required power.

The power requirements for mechanical devices such as pumps and pump drives are best expressed in terms of torque and speed.

7.2.3 Torque

Torque is defined as the moment of force required to produce rotation and is usually expressed in units of Nm (Newton metres), Kgfm (Kilogram metres) or *ftlb* (*foot pounds*).

Torque can be calculated as follows:

$$\text{Torque (Nm)} = \frac{\text{Required power (kW)} \times 9550}{\text{Pump speed (rev/min)}}$$

or

$$\text{Torque (Kgfm)} = \frac{\text{Required power (kW)} \times 974}{\text{Pump speed (rev/min)}}$$

or

$$\text{Torque (ftlb)} = \frac{\text{Required power (hp)} \times 5250}{\text{Pump speed (rev/min)}}$$

It should be noted that rotary lobe pumps are basically constant torque machines and therefore it is important that the transmission chosen is capable of transmitting the torque required by the pump. This is particularly important for variable speed drives which should be selected initially on torque rather than power.

7.2.4 Efficiency

Total Efficiency

Total efficiency is typically used on centrifugal and liquid ring pumps to describe the relationship between input power at the pump shaft and output power in the form of water horsepower. The term 'mechanical efficiency' can also be used to describe this ratio. Total efficiency, designated by symbol η , comprises of three elements, Hydraulic Efficiency (η_h), Mechanical Efficiency (η_m) and Volumetric Efficiency (η_v) which are described below:

Hydraulic Efficiency

The term hydraulic efficiency is used on centrifugal and liquid ring type pumps to describe one of the three elements of centrifugal and liquid ring pump total efficiency as described above.

$$\text{where Hydraulic Efficiency } (\eta_h) = \frac{\text{Pump head loss (m)}}{\text{Total head (m)}} \times 100\%$$

The pump head losses comprise of the shock loss at the eye of the impeller, friction loss in the impeller blade and circulation loss at the outlet side of the impeller blades.

Mechanical Efficiency

This term is used on all centrifugal, liquid ring and rotary lobe pump types, and is typically used to describe the losses associated with the transfer of energy from the prime mover through a mechanical system to the pumped liquid.

where

$$\text{Mechanical Efficiency } (\eta_m) = 1 - \frac{\text{Pump mechanical losses}}{\text{Required power}} \times 100\%$$

Pump mechanical losses refers to the friction losses associated with bearings, seals and other contacting areas within the pump.

Volumetric Efficiency

This term is used on all centrifugal, liquid ring and rotary lobe pump types. It is most commonly used to compare the performance of a number of pump types, where accurate geometric data is available.

For centrifugal and liquid ring pumps,

$$\text{Volumetric Efficiency } (\eta_v) = \frac{Q}{Q + Q_L} \times 100\%$$

where:

- Q = Pump capacity.
- Q_L = Fluid losses due to leakage through the impeller casing clearances.

For rotary lobe pumps the term volumetric efficiency (η_v) is used to compare the displacement of the pump against the capacity of the pump. The displacement calculation (q) per revolution for rotary lobe pumps involves calculating the volume of the void formed between the rotating element and the fixed element of the pump. This is then multiplied by the number of voids formed by a rotating element per revolution of the pump's drive shaft and by the number of rotors in the pump.

For rotary lobe pumps,

$$\text{Volumetric Efficiency } (\eta_v) = \frac{Q}{q} \times 100\%$$

where:

- Q = Pump capacity.
- q = Pump displacement.

Rotary lobe pumps are generally highly efficient and even at viscosity of 100 cP the volumetric efficiency of most pumps is approximately 90% for low pressure duties. At lower viscosities and/or higher pressures the volumetric efficiency will decrease due to slip as described in 8.6.1. Above 1000 cP, volumetric efficiency can be as high as 95 - 99%. For these high viscosity duties, to select a pump speed the following formulas can be used as a general guide.

$$n = \frac{Q \times 100}{q \times \eta_v \times 60} \quad \text{where } n = \text{pump speed (rev/min)}$$

$$Q = \text{capacity (m}^3\text{/h)}$$

$$q = \text{pump displacement (m}^3\text{/100 rev)}$$

$$\eta_v = \text{vol. efficiency (100\% = 1.0)}$$

or

$$n = \frac{Q \times 100}{q \times \eta_v} \quad \text{where } n = \text{pump speed (rev/min)}$$

$$Q = \text{capacity (US gall/min)}$$

$$q = \text{pump displacement (US gall/100 rev)}$$

$$\eta_v = \text{vol. efficiency (100\% = 1.0)}$$

or

$$n = \frac{Q \times 100}{q \times \eta_v} \quad \text{where } n = \text{pump speed (rev/min)}$$

$$Q = \text{capacity (UK gall/min)}$$

$$q = \text{pump displacement (UK gall/100 rev)}$$

$$\eta_v = \text{vol. efficiency (100\% = 1.0)}$$

Pump Efficiency

The term pump efficiency is used on all types of pumps to describe the ratio of power supply to the drive shaft against water horsepower.

$$\text{Pump Efficiency } \eta_p = \frac{\text{Water horse power}}{\text{Required power}} \times 100\%$$

or

$$\text{Pump Efficiency } \eta_p = \frac{Q \times H \times \rho \times g}{\omega \times T}$$

where:

- Q = capacity (m³/s)
- H = total head/pressure (m)
- ρ = fluid density (kg/m³)
- g = acceleration due to gravity (m/s²)
- ω = shaft angular velocity (rad/s)
- T = shaft torque (Nm)

Overall Efficiency

Overall efficiency is a term used to describe and compare the performance of all types of pump. Overall efficiency considers the efficiency of both the prime mover and the pump, and is sometimes known as the wire to water/liquid efficiency where the prime mover is an electric motor.

$$\text{Overall Efficiency } \eta_{\text{oa}} = \frac{\text{Water horse power}}{\text{Drive power}} \times 100\%$$

7.3 Centrifugal and Liquid Ring Pumps

In general the theory regarding sizing of centrifugal and liquid ring pumps is similar.

7.3.1 Flow Curve

A centrifugal or liquid ring pump should always be sized from a pump flow curve or a pump selection program. Most pump flow curves are based on tests with water. It is difficult to determine general curves for fluids with viscosities different from water and therefore in these instances it is recommended to use a pump selection program.

A pump flow curve specifies the connection between capacity Q , head H , required power P , required NPSH and efficiency η .

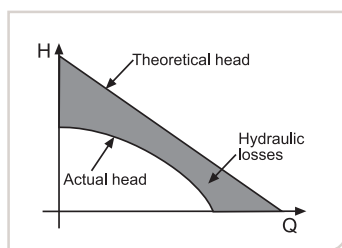

Fig. 7.3.1a Hydraulic losses

Hydraulic Losses

The connection between the capacity and the theoretical head of the pump is shown by means of a straight line, which decreases at a higher capacity (see fig. 7.3.1a).

The actual head of a pump is, however, lower than the theoretical head due to hydraulic losses in the pump, which are friction loss, pressure loss and slip.

The connection between the capacity and actual head is consequently specified by means of a curve which varies depending on the design of the impeller.

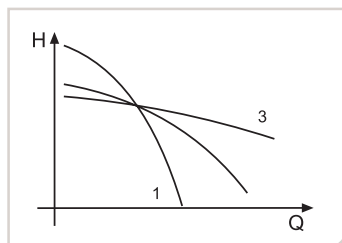

Fig. 7.3.1b Curves for Q and H

Different Pump Characteristics

The capacity Q and head H curve of a centrifugal pump will vary depending upon the impeller vane design (see fig. 7.3.1.b).

These fulfil different requirements and are well suited for flow control where only one parameter is to be changed (see 7.3.2).

Curve 1 covers a wide range of heads without large changes to capacity.

Curve 3 covers a wide range of capacities without large changes to head.

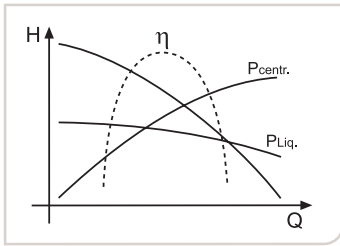

Fig. 7.3.1c Curves for Q, H, P and η

Curves for Capacity Q, Head H, Power P and Efficiency η

In principle the duty point of a pump can be situated at any point on the Q-H curve.

The efficiency of the pump will vary depending on where the duty point is situated on the Q-H curve. The efficiency is usually highest near the centre of the curve.

The power curve of the centrifugal pump increases at a higher capacity.

The power curve of the liquid ring pump decreases at a higher capacity.

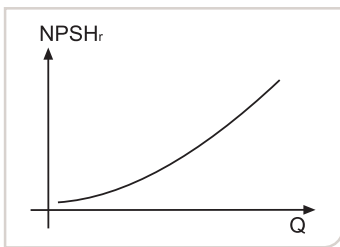

Fig. 7.3.1d NPSHr curve

NPSHr Curve

The NPSHr curve increases at higher capacity (see fig. 7.3.1d). This should be used to ascertain the NPSHr of the pump. It is important that NPSHr of the pump exceeds the NPSHa of the system.

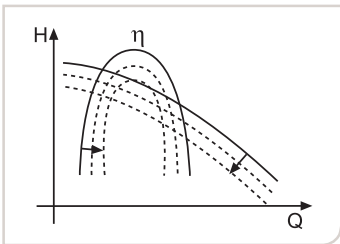

Fig. 7.3.1e Effects on Q, H and η

Viscosity Effect

Fluid viscosity will affect capacity, head, efficiency and power (see fig. 7.3.1e).

- Capacity, head and efficiency will decrease at higher viscosities.
- Required power will increase at higher viscosities.

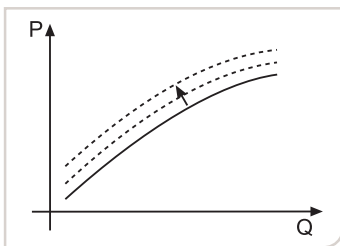

Fig. 7.3.1f Effects on Q, H and η

Density Effect

Fluid density will affect the head and required power which both increase proportionally at higher density (see fig. 7.3.1f).

How to use the Flow Curve

The flow curve consists of three different curves:

- Head as a function of capacity (Q - H curve).
- Required power as a function of capacity (Q - P curve).
- Required NPSH as a function of capacity (Q - NPSHr curve).

Although illustrated here the efficiency is not shown on the published flow curves but can be determined from the required power on the flow curve and formula in 7.2 when the duty point is known.

The Q - H and Q - P curves are specified for different standard impeller diameters so that a correct duty point can be determined. This is not applicable to the LKH-Multistage pump and Liquid Ring pumps as the impeller diameters cannot be reduced.

The curves on the flow curve are based on tests with water at 20°C (68°F) with tolerances of $\pm 5\%$. It is recommended to select the pump by means of a pump selection program if the fluid to be pumped has other physical properties.

Example:

Product/Fluid Data:

Fluid to be pumped - Water.
Viscosity - 1 cP.
SG - 1.0
Pumping temperature - 20°C.

Performance Data:

Capacity - 15 m³/h.
Total head - 25 m.
Electrical supply - 220/380v, 50Hz.

The optimum is to select the smallest pump possible which is suitable for the required duty point (15 m³/h, 25 m).

Step 1 - Find Appropriate Curve

Locate a flow curve for the required pump type that covers the duty point. For this particular example a flow curve of a centrifugal pump type LKH-10 with 3000 rev/min synchronous speed at 50Hz is selected.

Fig. 7.3.1g Example

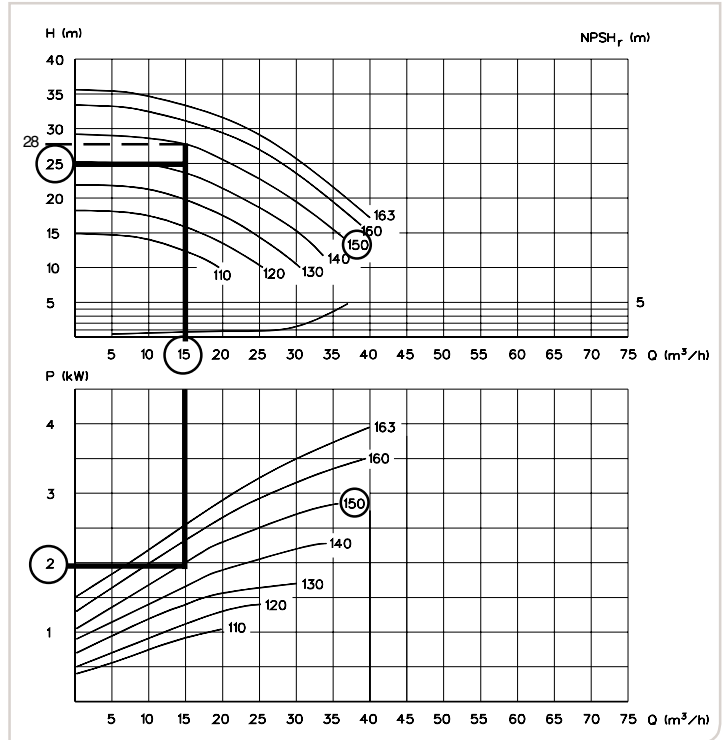

Step 2 - Look at Q - H curve

- Locate the capacity (15 m³/h) on the Q-scale.
- Start from this point and follow the vertical line upwards until it intersects with the horizontal line indicating the required head (25 m) on the H-scale.
- This duty point does not contact any curve corresponding to a certain impeller diameter. Therefore, the nearest larger size impeller diameter should be selected, in this case 150 mm.
- The head will then be 28 m.
- The selected head (28 m) should be checked regarding the lower tolerance of the curve to ensure that it is at least the required 25 m.
- In this case the head should be reduced by 5% being the curve tolerance.
- The head will then be a minimum of 26.6 m greater than 25 m, thus satisfactory.

Step 3 - Look at Q - P curve

- The next step in selecting the pump is to follow the vertical capacity line (15 m³/h) downwards until it intersects with the power curve for the 150 mm impeller.
- A horizontal line to the left of the intersection indicates a required power of 2.0 kW.
- For a LKH centrifugal pump a safety factor of 5% for motor losses must be added, resulting in a total required power of 2.1 kW.
- Consequently a 2.2 kW motor can be used.

Step 4 - Look at Q - NPSHr curve

- Finally the vertical capacity line (15 m³/h) is followed up to the NPSHr curve.
- The intersection corresponding to the 150 mm impeller is located.
- A horizontal line to the right of the intersection indicates that NPSHr is approx. 0.8 m.

7.3.2 Flow Control

Duty Point

The duty point of a pump is the intersection point between the pump curve and the process curve.

Pump curve - this specifies the connection between head H and capacity Q (see 7.3.1).

Process curve - this specifies the connection between the total pressure drop (ΔH) in the process plant and the capacity (Q) (see fig. 7.3.2a).

The process curve is determined by varying the capacity so that different pressure drop (ΔH) values are obtained. The shape of the process curve will depend on the process design (i.e. layout, valves, filters etc.).

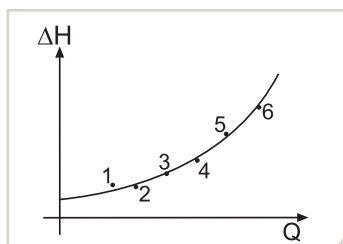

Capacity:	Q ₁	Q ₂	Q ₃	Q ₄	Q ₅	Q ₆
Pressure drop:	DH ₁	DH ₂	DH ₃	DH ₄	DH ₅	DH ₆

The duty point of a pump can change due to changes in the conditions of the process plant (changes in head, pressure drops etc.). The pump will automatically regulate the capacity to meet the new conditions (see fig. 7.3.2b and 7.3.2c).

Fig. 7.3.2a Process curve

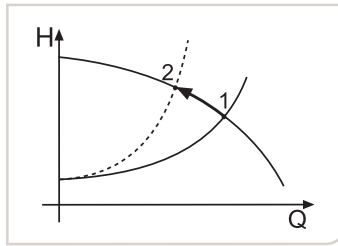

Fig. 7.3.2b Changes in pressure drop

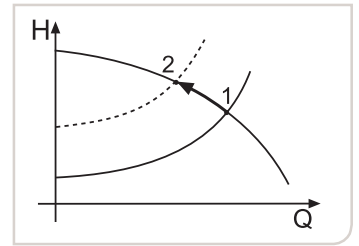

Fig. 7.3.2c Changes in required head

It is possible to compensate for the change of duty point by means of flow control that can be achieved as follows:

- Reducing the impeller diameter (not for liquid ring pumps).
- Throttling the discharge line.
- Controlling the pump speed.

Due to flow control it is possible to achieve optimum pump efficiency at the required capacity resulting in the most economical pump installation.

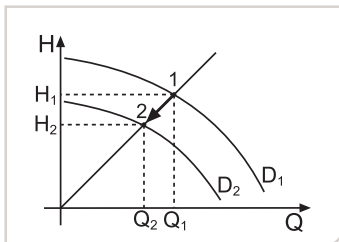

Fig. 7.3.2d Reducing impeller diameter

Reducing Impeller Diameter

Reducing the impeller diameter can only be carried out for centrifugal pumps and multi-stage centrifugal pumps. This will reduce the capacity and the head.

Centrifugal Pump

The connection between impeller diameter (D), capacity (Q) and head (H) is shown in fig. 7.3.2d:

1. Before reducing.
2. After reducing - the duty point moves towards point 2 when reducing the impeller diameter.

If the impeller speed remains unchanged, the connection between impeller diameter (D), capacity (Q), head (H) and required power (P) is shown by the following formulas:

Diameter/capacity: $\frac{Q_1}{Q_2} = \frac{D_1^3}{D_2^3} \Rightarrow D_2 = D_1 \times \sqrt[3]{\frac{Q_2}{Q_1}}$ [mm]

Diameter/head: $\frac{H_1}{H_2} = \frac{D_1^2}{D_2^2} \Rightarrow D_2 = D_1 \times \sqrt{\frac{H_2}{H_1}}$ [mm]

Diameter/power: $\frac{P_1}{P_2} = \frac{D_1^5}{D_2^5} \Rightarrow D_2 = D_1 \times \sqrt[5]{\frac{H_2}{H_1}}$ [mm]

Most pump flow curves show characteristics for different impeller diameters to enable the correct impeller diameter to be selected.

Reducing the impeller diameter by up to 20% will not affect the efficiency of the pump. If the reduction in impeller diameter exceeds 20%, the pump efficiency will decrease.

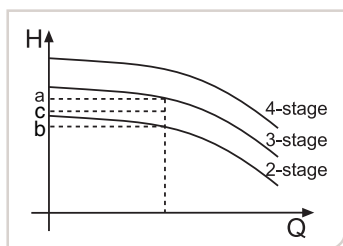

Fig. 7.3.2e Reducing impeller diameter

Multi-stage Centrifugal Pump

This pump has several impellers depending upon pump type. The total head can be adjusted by reducing the diameter of the back impeller, which is situated at the pump outlet (nearest to the back plate). Consequently the exact duty point will be between the curves of two pump sizes.

The connection between impeller diameter (D), capacity (Q), head (H) and type of pump is shown in fig. 7.3.2e.

The formula is for guidance purposes only. It is, therefore, recommended to add a safety factor of 10-15% to the new diameter.

The impeller diameter is reduced to D_2 by means of the following formula:

$$D_2 = D_1 \times \sqrt{\frac{c-b}{a-b}} \text{ [mm]}$$

Where:

D_1 = Standard diameter before reducing.

a = Max. duty point.

b = Min. duty point.

c = Required duty point.

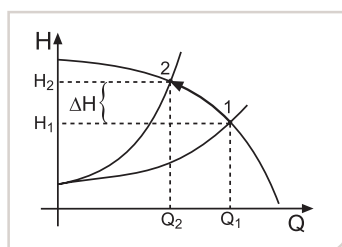

Fig. 7.3.2f Throttling discharge line

Throttling Discharge Line

Throttling the discharge line will increase the resistance in the process plant, which will increase the head and reduce the capacity. The connection between capacity (Q) and head (H) when throttling is shown in fig. 7.3.2f.

1. Before throttling.
2. After throttling, the duty point moves towards point 2.

Throttling should not be carried out in the suction line as cavitation can occur.

Also throttling will reduce the efficiency of the process plant ΔH shows the 'waste' of pressure at point 2.

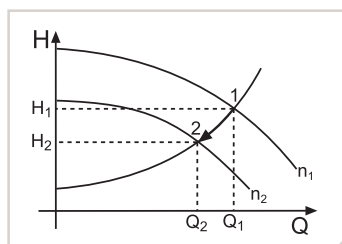

Fig. 7.3.2g Controlling pump speed

Controlling Pump Speed

Changing the impeller speed will change the centrifugal force created by the impeller. Therefore, the capacity and the head will also change.

The connection between capacity (Q) and head (H) when changing the impeller speed is shown in fig. 7.3.2g.

1. Before reducing impeller speed.
2. After reducing impeller speed. The working point moves towards point 2 when reducing the impeller speed.

The most common form of speed control is by means of a frequency converter (see 9.10).

If the impeller dimensions remain unchanged, the connection between impeller speed (n), capacity (Q), head (H) and required power (P) is shown by the following formulas:

$$\text{Speed/capacity: } \frac{Q_1}{Q_2} = \frac{n_1}{n_2} \Rightarrow n_2 = n_1 \times \frac{Q_2}{Q_1} \quad [\text{rev/min}]$$

$$\text{Speed/head: } \frac{H_1}{H_2} = \frac{n_1^2}{n_2^2} \Rightarrow n_2 = n_1 \times \sqrt{\frac{H_2}{H_1}} \quad [\text{rev/min}]$$

$$\text{Speed/power: } \frac{P_1}{P_2} = \frac{n_1^3}{n_2^3} \Rightarrow n_2 = n_1 \times \sqrt[3]{\frac{P_2}{P_1}} \quad [\text{rev/min}]$$

As shown from the above formulas the impeller speed affects capacity, head and required power as follows:

- Half speed results in capacity x 0.5.
- Half speed results in head x 0.25.
- Half speed results in required power x 0.125.

Speed control will not affect the efficiency providing changes do not exceed 20%.

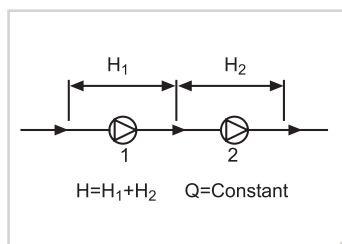

Fig. 7.3.3a Principle of connection

7.3.3 Alternative Pump Installations

Pumps Coupled in Series

It is possible to increase the head in a pump installation by two or more pumps being coupled in series.

The capacity (Q) will always be constant throughout the pump series. The head can vary depending on the pump sizes.

The outlet of pump 1 is connected to the inlet of pump 2. Pump 2 must be able to withstand the outlet head from pump 1.

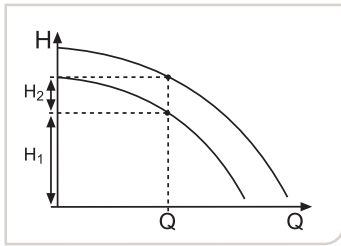

Fig. 7.3.3b Head of pumps in series

If two different pumps are connected in series, the pump with the lowest NPSH value should be installed as the first pump (for critical suction conditions).

The capacity in the pump installation should not exceed the max. capacity of the smallest pump. Otherwise there will be a pressure drop in the smallest pump.

A multi-stage centrifugal pump is in principle several pumps that are coupled in series but built together as one pump unit.

Pumps Coupled in Parallel

It is possible to increase the capacity in a pump installation by two or more pumps coupled in parallel.

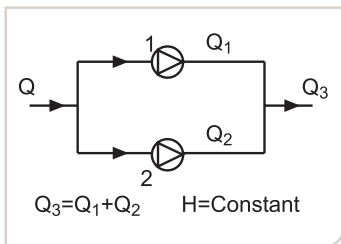

Fig. 7.3.3c Principle of connection

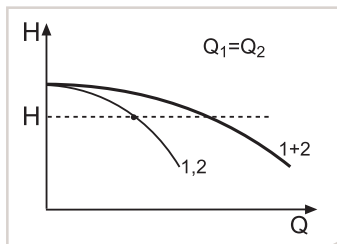

Fig. 7.3.3d Connection of two similar pumps

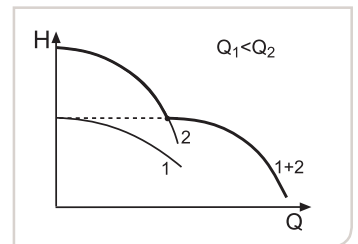

Fig. 7.3.3e Connection of two different pumps

The head (H) will always be constant in the pump installation. The capacity can vary depending on the pump sizes.

The pumps receive the fluid from the same source and have a common discharge line.

When the capacity is increased by means of pumps coupled in parallel, the equipment and pressure drop in the installation must be determined according to the total capacity of the pumps.

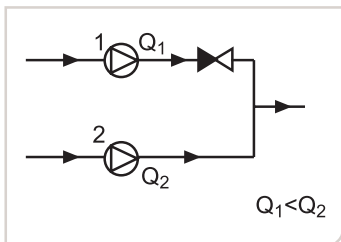

Fig. 7.3.3f Connection of two different pump sizes

For two different pumps, If the capacity Q₁ is smaller than the capacity Q₂, it is possible to install a non-return valve in the discharge line of pump 1 to avoid pump 2 pumping fluid back through pump 1.

7.4 Worked Examples of Centrifugal Pump Sizing (Metric units)

7.4.1 Example 1

The following example shows a pump to be sized for a typical brewery process.

The pump is required to handle Wort from the Whirlpool to the Fermentation vessel.

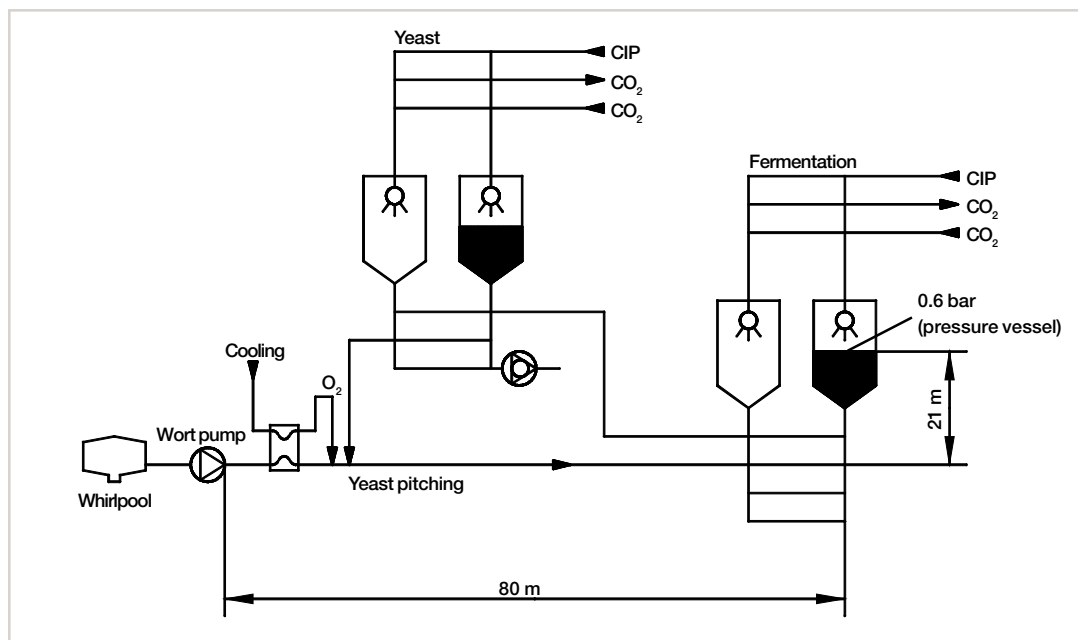

Fig. 7.4.1a Example 1

As described in 7.1 in order to correctly size any type of pump, some essential information is required such as Product/Fluid data, Performance data and Site Services data.

All the data has been given by the customer.

Product/Fluid data:

- Fluid to be pumped - Wort.
- Viscosity - 1 cP.
- Pumping temperature - 90°C.

Performance data:

- Capacity - 40 m³/h.
- Discharge - via 80 m of 101.6 mm dia. tube, plus a given number of bends, valves and a plate heat exchanger with Δp_{PHE} 1.6 bar.
Static head in Fermenting vessel = 21 m.
Pressure in Fermenting vessel = 0.6 bar.
- Suction - 0.4 m head, plus a given number of bends and valves.

Site Services data:

- Electrical supply - 220/380v, 50 Hz.

Before sizing a pump, it will be necessary to determine the total head and NPSHa. The theory, including the different formulae regarding these parameters is more specifically described in 2.2.2 and 2.2.4.

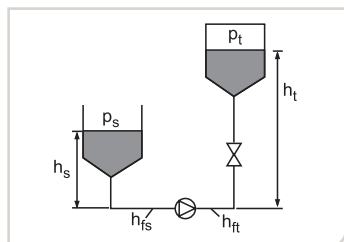

Fig. 7.4.1b

Total head

$$\text{Total discharge head } H_t = h_t + h_{ft} + p_t$$

- Where
- h_t = Static head in Fermentation vessel.
 - h_{ft} = Total pressure drop in discharge line.
 - p_t = Pressure in Fermentation vessel.

Therefore

$$h_t = 21 \text{ m.}$$

$$h_{ft} = \text{Pressure drop in tube } \Delta p_{\text{tube}} + \text{Pressure drop in bends and valves } \Delta p + \text{Pressure drop in plate heat exchanger } \Delta p_{\text{PHE}}$$

$$\Delta p_{\text{tube}} \text{ from curve shown in } 14.5 = 2 \text{ m.}$$

$$\Delta p \text{ is calculated to be } 5 \text{ m.}$$

$$\Delta p_{\text{PHE}} \text{ is given as } 1.6 \text{ bar} = 16 \text{ m.}$$

$$h_{ft} = 2 + 5 + 16 \text{ m.}$$

$$= 23 \text{ m.}$$

$$p_t = 0.6 \text{ bar} = 6 \text{ m.}$$

$$H_t = h_t + h_{ft} + p_t = 21 + 23 + 6 \text{ m} = 50 \text{ m (5 bar).}$$

Total suction head $H_s = h_s - h_{fs} + p_s$

Where h_s = Static suction head in Whirlpool.
 h_{fs} = Total pressure drop in suction line.
 p_s = Pressure in Whirlpool (open tank).

Therefore h_s = 0.4 m.
 h_{fs} = calculated to be 1 m.
 p_s = 0 (open tank).

$H_s = h_s - h_{fs} + p_s = 0.4 - 1 + 0 \text{ m} = -0.6 \text{ m} (-0.06 \text{ bar})$.

Total head $H = H_t - H_s = 50 - (-0.6) = 50.6 \text{ m} \approx 51 \text{ m} (5.1 \text{ bar})$.

NPSHa

$NPSHa = Pa + h_s - h_{fs} - Pvp$

Where Pa = Pressure absolute above level of fluid in Whirlpool tank.
 h_s = Static suction head in Whirlpool tank.
 h_{fs} = Total pressure drop in suction line.
 Pvp = Vapour pressure of fluid.

Therefore Pa = 1 bar (open tank) = 10 m.
 h_s = 0.4 m.
 h_{fs} = Calculated to be 1 m.
 Pvp = 0.70 bar a (from table 14.4a) = 7 m.

$NPSHa = 10 + 0.4 - 1 - 7 \text{ (m)} = 2.4 \text{ m}$.

Actual pump sizing can be made using pump performance curves or a pump selection program. The performance curves are, however, not suitable if the fluid to be pumped has physical properties (i.e. viscosity) different from water. In this particular example both the pump performance curves and pump selection program can be used. The performance curve selection procedure is more specifically described in 7.3.1.

For this particular example, pump sized would be as follows:

- Pump model - LKH-25.
- Impeller size - 202 mm.
- Speed - 2930 rev/min.
- Capacity - 40 m³/h.
- Head - 51.5 m (5.15 bar).
- Efficiency - 63.1%.
- NPSHr - 1.4 m.
- Motor size - 11 kW.

Cavitation check:

NPSHa should be greater than NPSHr i.e. $2.4 \text{ m} > 1.4 \text{ m}$,
i.e. no cavitation will occur.

The recommended shaft seal type based upon Alfa Laval application experience and guidelines would be a double mechanical seal with carbon/silicon carbide faces and EPDM elastomers.

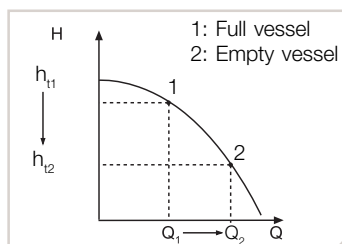

Fig. 7.4.1c

Special Note

The discharge head (h_{12}) is lower when the pump starts filling the fermenting vessel compared to the discharge head (h_{11}) when the vessel is full. The reduction of the discharge head can result in cavitation and overloading of the motor due to a capacity increase. Cavitation can be avoided by reducing the pump speed (reducing NPSHr), i.e. by means of a frequency converter, or by throttling the discharge line (increasing head). The flow control method is more specifically described in 7.3.2.

Adjustment

In this example the pump is sized by the pump selection program which results in exact impeller diameter of 202 mm, so that the selected duty point is as close to the required duty point as possible.

The pump is sized with a standard impeller diameter if using the performance curve. In this case it may be necessary to adjust the selected duty point by means of flow control.

It is important to note that the selected head has a tolerance of $\pm 5\%$ due to the tolerance of the pump curve. Consequently, there is a risk that the pump will generate head which will differ from the selected head. If the required head is the exact value of the process, it is recommended to select the pump with a larger impeller diameter to ensure the required head is obtained.

It may also be necessary to adjust to the required duty point by means of flow control due to the tolerance. Flow control method is more specifically described in 7.3.2.

7.4.2 Example 2

The following example shows a centrifugal pump to be sized for a typical dairy process.

Pump 'A' is a Raw Milk pump in connection with a pasteuriser. The raw milk is pumped from a Balance tank to a Separator via the preheating stage in the plate heat exchanger.

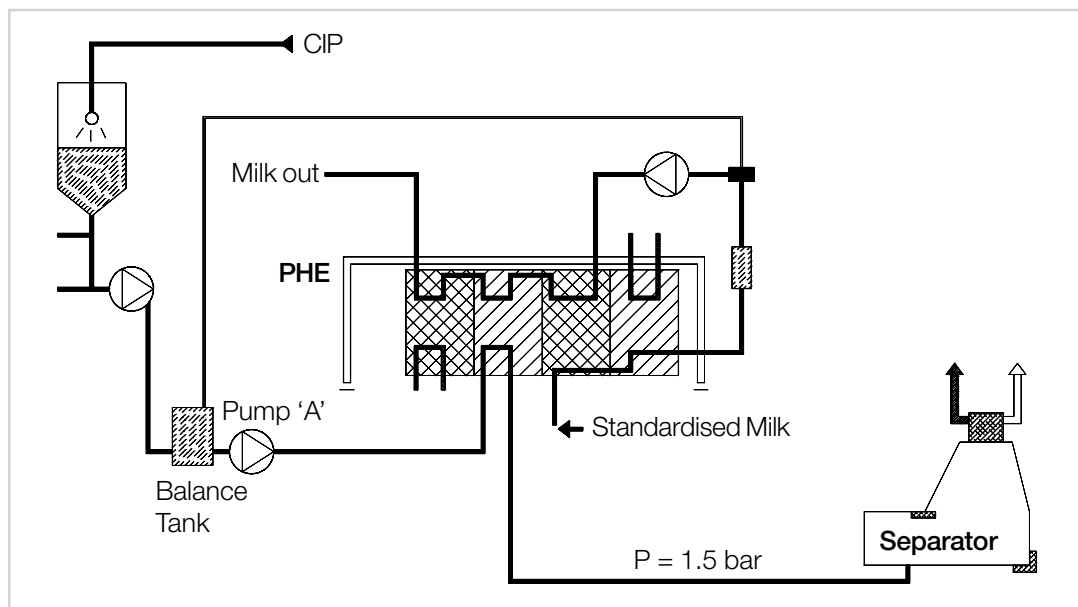

Fig. 7.4.2a Example 2

As described in 7.1 in order to correctly size any type of pump, some essential information is required such as Product/Fluid data, Performance data and Site Services data.

All the data has been given by the customer.

Product/Fluid data:

- Fluid to be pumped - Raw Milk.
- Viscosity - 5 cP.
- Pumping temperature- 5°C.

Performance data:

- Capacity - 30 m³/h.
- Discharge - via 5 m of horizontal 76 mm dia. tube, plus a given number of bends, valves and a plate heat exchanger with Δp_{PHE} 1 bar.
Inlet pressure for the separator = 1.5 bar.
- Suction - 0.1 m head, plus a given number of bends and valves.

Site Services data:

Electrical supply - 220/380v, 50 Hz.

Before sizing a pump, it will be necessary to determine the total head and NPSHa. The theory, including the different formulae regarding these parameters is more specifically described in 2.2.2 and 2.2.4.

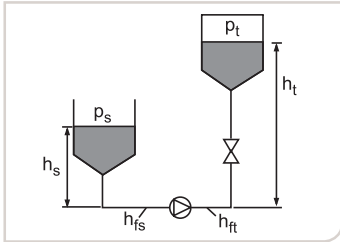

Fig. 7.4.2b

Total head

Total discharge head $H_t = h_t + h_{ft} + p_t$

- Where h_t = Static head to Separator.
 h_{ft} = Total pressure drop in discharge line.
 p_t = Pressure in Separator.

- Therefore $h_t = 0$ m (no static head - only horizontal tube).
 $h_{ft} =$ Pressure drop in tube Δp_{tube} + Pressure drop in bends and valves Δp + Pressure drop in plate heat exchanger Δp_{PHE}
 Δp_{tube} from curve shown in 14.5 = 2 m.
 Δp is calculated to be 0 m.
 Δp_{PHE} is given as 1.0 bar = 10 m.
 $h_{ft} = 2 + 0 + 10$ m.
 $= 12$ m.
 $p_t = 1.5$ bar = 15 m.

$H_t = h_t + h_{ft} + p_t = 0 + 12 + 15$ m = 27 m (2.7 bar).

Total suction head $H_s = h_s - h_{fs} + p_s$

- Where h_s = Static suction head in Balance tank.
 h_{fs} = Total pressure drop in suction line.
 p_s = Pressure in Balance tank (open tank).

- Therefore $h_s = 0.1$ m.
 $h_{fs} =$ calculated to be 0.4 m.
 $p_s = 0$ (open tank).

$H_s = h_s - h_{fs} + p_s = 0.1 - 0.4 + 0$ m = -0.3 m (-0.03 bar).

Total head $H = H_t - H_s = 27 - (-0.3) = 27.3$ m \approx 27 m (2.7 bar).

NPSHa

$$\text{NPSHa} = P_a + h_s - h_{fs} - P_{vp}$$

Where P_a = Pressure absolute above level of fluid in Balance tank.

h_s = Static suction head in Balance tank.

h_{fs} = Total pressure drop in suction line.

P_{vp} = Vapour pressure of fluid.

Therefore P_a = 1 bar (open tank) = 10 m.

h_s = 0.1 m.

h_{fs} = Calculated to be 0.4 m.

P_{vp} = at temperature of 5°C this is taken as being negligible i.e. 0 bar a = 0 m.

$$\text{NPSHa} = 10 + 0.1 - 0.4 - 0 \text{ (m)} = 9.7 \text{ m.}$$

As the fluid to be pumped has physical properties (i.e. viscosity) different from water, the pump performance curves should not be used, and actual pump sizing should be made using the pump selection program.

For this particular example, pump sized would be as follows:

- Pump model - LKH-20.
- Impeller size - 149 mm.
- Speed - 2840 rev/min.
- Capacity - 30 m³/h.
- Head - 27.1 m (2.71 bar).
- Efficiency - 65.9%.
- NPSHr - 1.4 m.
- Motor size - 4 kW.

Cavitation check:

NPSHa should be greater than NPSHr i.e. 9.7 m > 1.4 m, i.e. no cavitation will occur.

The recommended shaft seal type based upon Alfa Laval application experience and guidelines would be a single mechanical seal with carbon/silicon carbide faces and EPDM elastomers.

7.5 Worked Examples of Centrifugal Pump Sizing (US units)

7.5.1 Example 1

The following example shows a pump to be sized for a typical brewery process.

The pump is required to handle Wort from the Whirlpool to the Fermentation vessel.

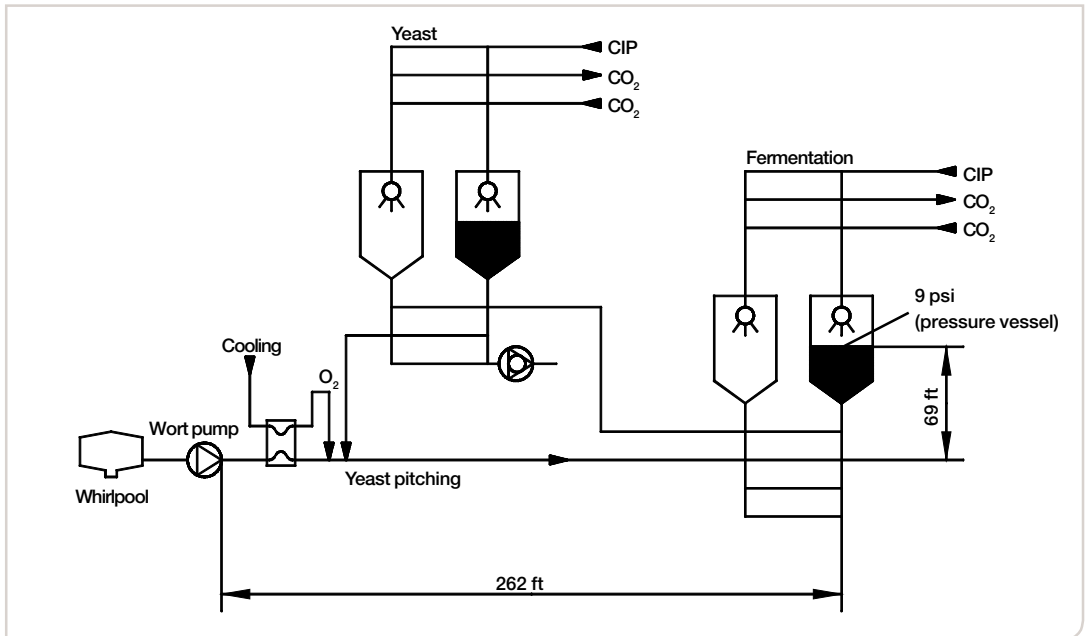

Fig. 7.5.1a Example 1

As described in 7.1 in order to correctly size any type of pump, some essential information is required such as Product/Fluid data, Performance data and Site Services data.

All the above data has been given by the customer.

Product/Fluid data:

- Fluid to be pumped - Wort.
- Viscosity - 1 cP.
- Pumping temperature - 194°F.

Performance data:

- Capacity - 176 US gall/min.
- Discharge - via 262 ft of 4 in dia. tube, plus a given number of bends, valves and a plate heat exchanger with Δp_{PHE} 23 psi.
 Static head in Fermenting vessel = 69 ft.
 Pressure in Fermenting vessel = 9 psi.
- Suction - 1.5 ft head, plus a given number of bends and valves.

Site Services data:

- Electrical supply - 230/460v, 60 Hz.

Before sizing a pump, it will be necessary to determine the total head and NPSHa. The theory, including the different formulae regarding these parameters is more specifically described in 2.2.2 and 2.2.4.

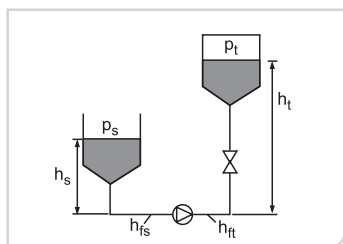

Fig. 7.5.1b

Total head

Total discharge head $H_t = h_t + h_{ft} + p_t$

- Where
- h_t = Static head in Fermentation vessel.
 - h_{ft} = Total pressure drop in discharge line.
 - p_t = Pressure in Fermentation vessel.

- Therefore
- $h_t = 69$ ft.
 - $h_{ft} =$ Pressure drop in tube Δp_{tube} + Pressure drop in bends and valves Δp + Pressure drop in plate heat exchanger Δp_{PHE}
 Δp_{tube} from curve shown in 14.5 = 6 ft.
 Δp is calculated to be 16 ft.
 Δp_{PHE} is given as 23 psi = 53 ft.
 - $h_{ft} = 6 + 16 + 53$ ft.
 $= 75$ ft.
 - $p_t = 9$ psi = 20 ft.

$H_t = h_t + h_{ft} + p_t = 69 + 75 + 20$ ft = 164 ft (71 psi).

Total suction head $H_s = h_s - h_{fs} + p_s$

Where h_s = Static suction head in Whirlpool.
 h_{fs} = Total pressure drop in suction line.
 p_s = Pressure in Whirlpool (open tank).

Therefore h_s = 1.5 ft.
 h_{fs} = calculated to be 3 ft.
 p_s = 0 (open tank).

$H_s = h_s - h_{fs} + p_s = 1.5 - 3 + 0 \text{ m} = -1.5 \text{ ft} (-0.6 \text{ psi})$

Total head $H = H_t - H_s = 164 - (-1.5) = 165.5 \text{ ft} \approx 166 \text{ ft} (72 \text{ psi})$

NPSHa

$NPSHa = Pa + h_s - h_{fs} - Pvp$

Where Pa = Pressure absolute above level of fluid in Whirlpool tank.
 h_s = Static suction head in Whirlpool tank.
 h_{fs} = Total pressure drop in suction line.
 Pvp = Vapour pressure of fluid.

Therefore Pa = 14.7 psi (open tank) = 33.9 ft.
 h_s = 1.5 ft.
 h_{fs} = Calculated to be 3 ft.
 Pvp = 10 psia (from table 14.4a) = 23 ft.

$NPSHa = 33.9 + 1.5 - 3 - 23 \text{ (ft)} = 9.4 \text{ ft}$

Actual pump sizing can be made using pump performance curves or a pump selection program. The performance curves are, however, not suitable if the fluid to be pumped has physical properties (i.e. viscosity) different from water. In this particular example both the pump performance curves and pump selection program can be used. The performance curve selection procedure is more specifically described in 7.3.1.

For this particular example, pump sized would be as follows:

Pump model - LKH-20.
 Impeller size - 6.50 in.
 Speed - 3500 rev/min.
 Capacity - 176 US gall/min.
 Head - 166.2 ft (72 psi).
 Efficiency - 67.2%.
 NPSHr - 7.5 ft.
 Motor size - 15 hp.

Cavitation check:

NPSHa should be greater than NPSHr i.e. 9.4 ft > 7.5 ft, i.e. no cavitation will occur.

The recommended shaft seal type based upon Alfa Laval application experience and guidelines would be a double mechanical seal with carbon/silicon carbide faces and EPDM elastomers.

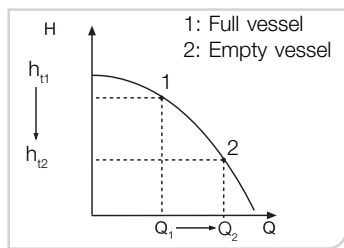

Fig. 7.5.1c

Special Note

The discharge head (h_{t2}) is lower when the pump starts filling the fermenting vessel compared to the discharge head (h_{t1}) when the vessel is full. The reduction of the discharge head can result in cavitation and overloading of the motor due to a capacity increase. Cavitation can be avoided by reducing the pump speed (reducing NPSHr), i.e. by means of a frequency converter, or by throttling the discharge line (increasing head). The flow control method is more specifically described in 7.3.2.

Adjustment

In this example the pump is sized by the pump selection program which results in exact impeller diameter of 6.50 in, so that the selected duty point is as close to the required duty point as possible.

The pump is sized with a standard impeller diameter if using the performance curve. In this case it may be necessary to adjust the selected duty point by means of flow control.

It is important to note that the selected head has a tolerance of $\pm 5\%$ due to the tolerance of the pump curve. Consequently, there is a risk that the pump will generate head which will differ from the selected head. If the required head is the exact value of the process, it is recommended to select the pump with a larger impeller diameter to ensure the required head is obtained.

It may also be necessary to adjust to the required duty point by means of flow control due to the tolerance. Flow control method is more specifically described in 7.3.2.

7.5.2 Example 2

The following example shows a centrifugal pump to be sized for a typical dairy process.

Pump 'A' is a Raw Milk pump in connection with a pasteuriser. The raw milk is pumped from a Balance tank to a Separator via the preheating stage in the plate heat exchanger.

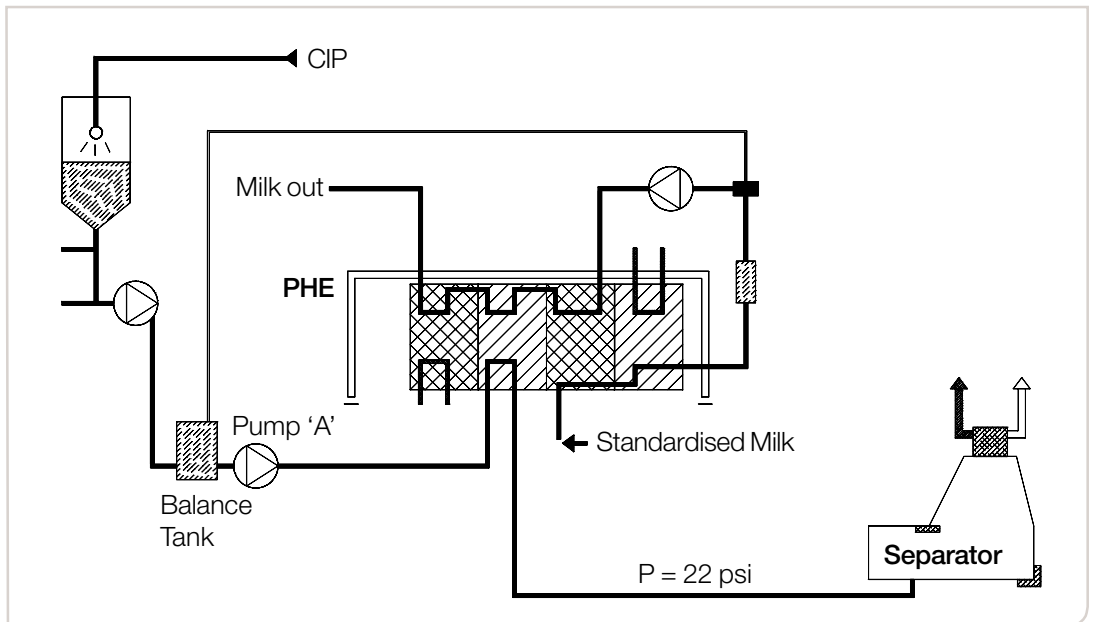

Fig. 7.5.2a Example 2

As described in 7.1 in order to correctly size any type of pump, some essential information is required such as Product/Fluid data, Performance data and Site Services data.

All the data has been given by the customer.

Product/Fluid data:

- Fluid to be pumped - Raw Milk.
- Viscosity - 5 cP.
- Pumping temperature - 41°F.

Performance data:

- Capacity - 132 US gall/min.
- Discharge - via 16 ft of horizontal 3 in dia. tube, plus a given number of bends, valves and a plate heat exchanger with Δp_{PHE} 15 psi.
Inlet pressure for the separator = 22 psi.
- Suction - 0.3 ft head, plus a given number of bends and valves.

Site Services data:

Electrical supply - 230/460v, 60 Hz.

Before sizing a pump, it will be necessary to determine the total head and NPSHa. The theory, including the different formulae regarding these parameters is more specifically described in 2.2.2 and 2.2.4.

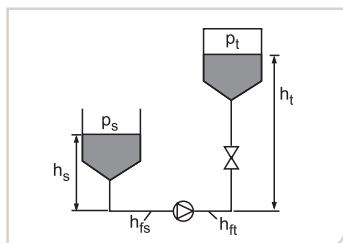

Fig. 7.5.2b

Total head

Total discharge head $H_t = h_t + h_{ft} + p_t$

Where h_t = Static head to Separator.
 h_{ft} = Total pressure drop in discharge line.
 p_t = Pressure in Separator.

Therefore h_t = 0 ft (no static head - only horizontal tube).
 h_{ft} = Pressure drop in tube Δp_{tube} + Pressure drop in bends and valves Δp + Pressure drop in plate heat exchanger Δp_{PHE}

Δp_{tube} from curve shown in 14.5 = 6 ft.

Δp is calculated to be 0 ft.

Δp_{PHE} is given as 15 psi = 34 ft.

$h_{ft} = 6 + 0 + 34$ ft.

= 40 ft.

$p_t = 22$ psi = 50 ft.

$H_t = h_t + h_{ft} + p_t = 0 + 40 + 50$ ft = 90 ft (39 psi).

Total suction head $H_s = h_s - h_{fs} + p_s$

Where h_s = Static suction head in Balance tank.
 h_{fs} = Total pressure drop in suction line.
 p_s = Pressure in Balance tank (open tank).

Therefore $h_s = 0.3$ ft.

h_{fs} = calculated to be 1.3 ft.

$p_s = 0$ (open tank).

$H_s = h_s - h_{fs} + p_s = 0.3 - 1.3 + 0$ m = - 1 ft (- 0.4 psi).

Total head $H = H_t - H_s = 90 - (- 1) = 91$ ft (39 psi).

NPSHa

$$NPSHa = Pa + h_s - h_{fs} - Pvp$$

Where Pa = Pressure absolute above level of fluid in Balance tank.

h_s = Static suction head in Balance tank.

h_{fs} = Total pressure drop in suction line.

Pvp = Vapour pressure of fluid.

Therefore Pa = 14.7 psi (open tank) = 33.9 ft.

h_s = 0.3 ft.

h_{fs} = Calculated to be 1.3 ft.

Pvp = at temperature of 41° F this is taken as being negligible i.e. 0 psia = 0 ft.

$$NPSHa = 33.9 + 0.3 - 1.3 - 0 \text{ (ft)} = 32.9 \text{ ft.}$$

As the fluid to be pumped has physical properties (i.e. viscosity) different from water, the pump performance curves should not be used, and actual pump sizing should be made using the pump selection program.

For this particular example, pump sized would be as follows:

Pump model	- LKH-10.
Impeller size	- 5.59 in.
Speed	- 3500 rev/min.
Capacity	- 132 US gall/min.
Head	- 92 ft (40 psi).
Efficiency	- 64.7%.
NPSHr	- 4.7 ft.
Motor size	- 5.0 hp.

Cavitation check:

NPSHa should be greater than NPSHr i.e. 32.9 ft > 4.7 ft, i.e. no cavitation will occur.

The recommended shaft seal type based upon Alfa Laval application experience and guidelines would be a single mechanical seal with carbon/silicon carbide faces and EPDM elastomers.

7.6 Rotary Lobe Pumps

7.6.1 Slip

Slip is the fluid lost by leakage through the pump clearances. The direction of slip will be from the high pressure to the low pressure side of the pump i.e. from pump outlet to pump inlet. The amount of slip is dependent upon several factors.

Fig. 7.6.1a Slip

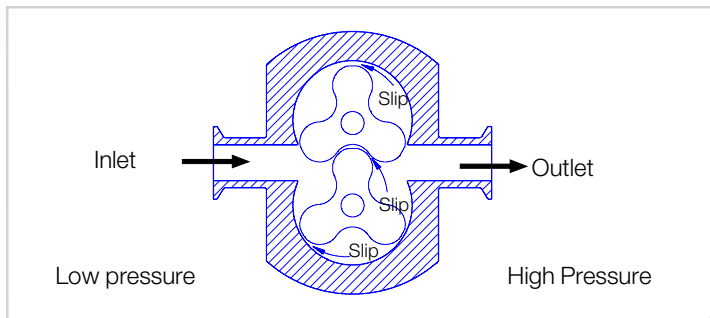

Clearance effect

Increased clearances will result in greater slip. The size and shape of the rotor will be a factor in determining the amount of slip.

Pressure effect

The amount of slip will increase as pressure increases which is shown below. In Fig 7.6.1b for a given pump speed the amount of slip can be seen as the capacity at 'zero' bar less the capacity at 'X' bar. To overcome this amount of slip it will be necessary to increase the pump speed to maintain the capacity required as shown in Fig 7.6.1c.

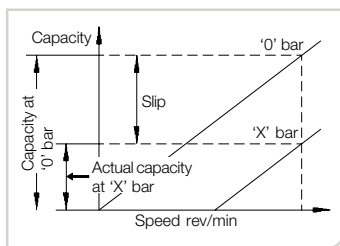

Fig. 7.6.1b Pressure effect

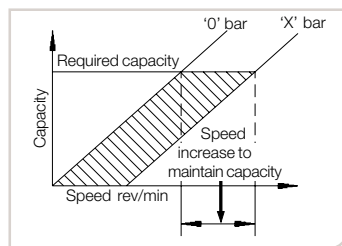

Fig. 7.6.1c Pressure effect

Viscosity effect

The amount of slip will decrease as fluid viscosity increases. The effect of viscosity on slip is shown in Figs 7.6.1d, 7.6.1e and 7.6.1f below. The pressure lines will continue to move towards the 'zero' pressure line as the viscosity increases.

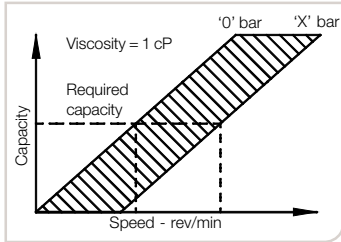

Fig. 7.6.1d Viscosity effect

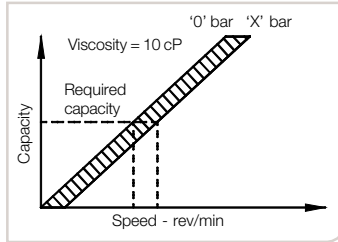

Fig. 7.6.1e Viscosity effect

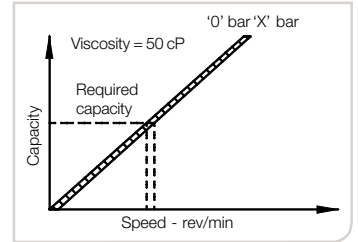

Fig. 7.6.1f Viscosity effect

Pump Speed effect

Slip is independent of pump speed. This factor must be taken into consideration when operating pumps at low speeds with low viscosity fluids. For example, the amount of slip at 400 rev/min pump speed will be the same as the amount of slip at 200 rev/min pump speed providing pressure is constant.

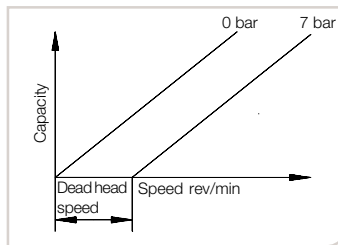

Fig. 7.6.1g Dead head speed

The pump speed required to overcome slip is known as the 'dead head speed'.

It is important to note that flow will be positive after overcoming the dead head speed.

A summary of effects of different parameters on slip is shown below:

Slip increases with pressure

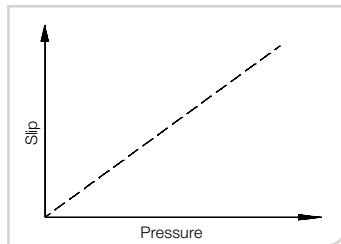

Fig. 7.6.1h

Slip increases with clearances

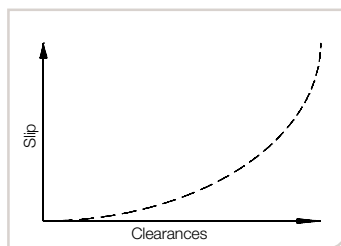

Fig. 7.6.1i

Slip decreases with viscosity

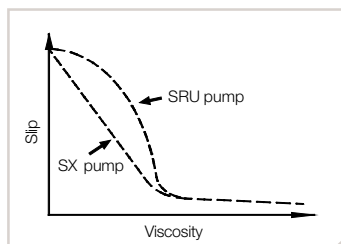

Fig. 7.6.1j

In general terms it is common to find the recommendation for the inlet pipe size to be the same diameter as the pump inlet connection.

7.6.2 Initial Suction Line Sizing

For guidance purposes only on high viscosity duties, the suction line can be initially sized using the initial suction line sizing curve (see 14.9) where the relationship between viscosity and flow rate provides an indication of pipe sizing.

For example, for a flow rate of 10 m³/h on a fluid with viscosity 900 cSt, a pump with 40 mm (1½ in) diameter suction line would be initially selected.

It is important to note this is only an approximate guide and care should be taken not to exceed the pump's viscosity/speed limit.

7.6.3 Performance Curve

Alfa Laval rotary lobe pumps can be sized from published performance curves or a pump selection program. Due to pumphead clearances described in 8.2.2, different performance curves are used for the various temperature ratings for rotors i.e. 70°C (158°F), 130°C (266°F) and 200°C (392°F). The SX pump range has only 150°C (302°F) rotor temperature rating. For convenience viscosity units are stated as cSt.

How to use the Performance Curve

The performance curve consists of four different curves:

- Capacity as a function of speed, related to pressure and viscosity.
- Power as a function of speed, related to pressure and viscosity of 1 cSt.
- Power as a function of viscosity greater than 1 cSt.
- Speed as a function of viscosity.

The curves are based on water at 20°C (68°F) but are shown with calculated viscosity correction data. Example shown refers to the SRU pump range but the same sizing procedure is also used for the SX pump range.

Example:

Product/Fluid Data:

- Fluid to be pumped - Vegetable Oil.
- Viscosity - 100 cSt.
- SG - 0.95
- Pumping temperature- 30°C.

Performance Data:

- Capacity - 3.6 m³/h (15.8 US gall/min).
- Total Pressure - 8 bar (116 psig).

The optimum is to size the smallest pump possible as hydraulic conditions dictate. However other factors such as fluid behaviour, solids etc. should be considered.

Step 1 – Find Appropriate Curve

Locate a curve for the required pump model that covers the performance data. Due to the large number of curves available it is not practical to include all performance curves in this handbook. Curves can be obtained from the pump supplier. However, the sizing process would be as follows:

From the initial suction line sizing curve (see 14.9), a pump with a size 25 mm (1 in) inlet connection would be required. Although the smallest pump models SRU1/005 and SRU1/008 have 25 mm (1 in) pump inlet connections, the flow rate required would exceed the pumps speed limit on the performance curve. For this particular example, we therefore need to select a performance curve for the pump model SRU2/013/LS with 70°C (158°F) rotor clearances, as shown in Fig. 7.6.3a, being the next appropriate pump size.

Fig. 7.6.3a SRU2/013/LS curves

Typical Performance Curve SRU2/013/LS or HS

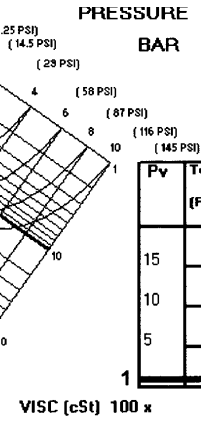
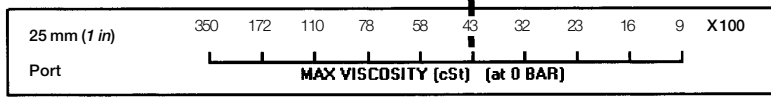
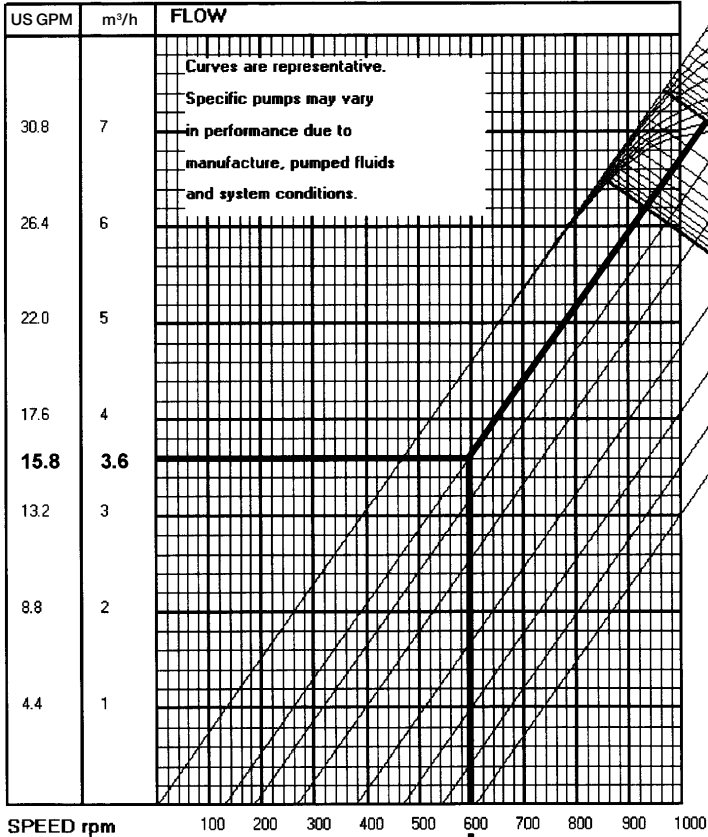

ROTORS - ST.STL
TRILOBE
10 BAR (145 PSI)
70 °C (158 °F)

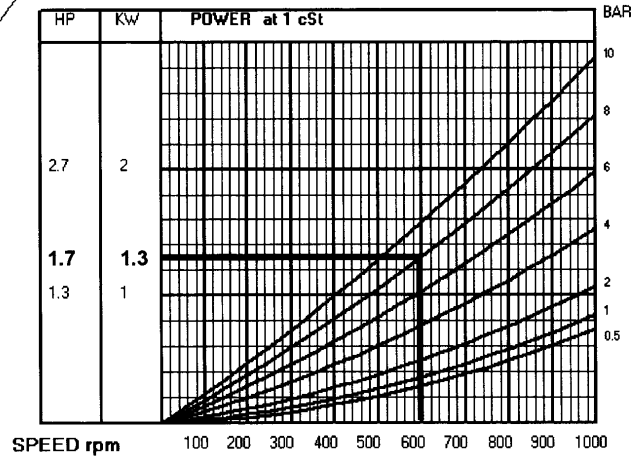
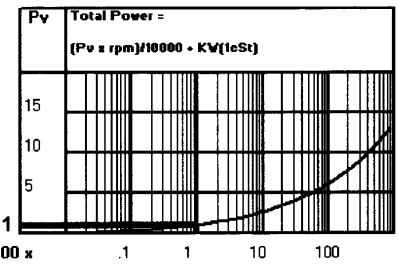

MAX SPEED
= 1000 rpm

Step 2 - Find Viscosity and Pressure

Begin with viscosity and find the intersection point with duty pressure.
From example - 100 cSt and 8 bar (115 psig).

Step 3 - Find Flow Rate

Move diagonally downward and find intersection with required flow rate.
From example – 3.6 m³/h (15.8 US gall/min).

Step 4 - Find Speed

Move vertically downward to determine necessary pump speed.
From example - 600 rev/min.

Step 5 - Viscosity/Port Size Check

Move vertically downward and check that maximum viscosity rating has not been exceeded against relevant inlet size.
From example - maximum viscosity rating 4300 cSt.

Step 6 - Find Power

The power required by a pump is the summation of the hydraulic power and various losses that occur in the pump and pumping system. Viscosity has a marked effect on pump energy losses. The losses being due to the energy required in effecting viscous shear in the pump clearances. Viscous power is the power loss due to viscous fluid friction within the pump (Pv factor).

Typically curves are used in conjunction with equation as follows:

$$\text{Total Required Power (kW)} = \frac{\text{Pv} \times \text{Pump speed (rev/min)}}{10000} + \text{Hydraulic power at 1 cSt (kW)}$$

where Pv = Power/viscosity factor

From example:

- At speed 600 rev/min the hydraulic power at 1 cSt is 1.3 kW,
- At viscosity 100 cSt the Pv factor is 1.0

$$\text{Total Required Power (kW)} = \frac{\text{Pv} \times \text{Pump speed (rev/min)}}{10000} + \text{Hydraulic power at 1 cSt (kW)}$$

$$= \frac{1.0 \times 600}{10000} + 1.3$$

$$= 1.36 \text{ kW}$$

It should be noted, this is the power needed at the pump shaft and the appropriate motor power must be selected, which in this instance would be 1.5 kW being the nearest motor output power above the required power.

Step 7 - Find NPSHr

NPSHr can be found by looking at the appropriate NPSH pump curve, which is a function of speed and expressed in metres water column (mwc) or feet (ft).

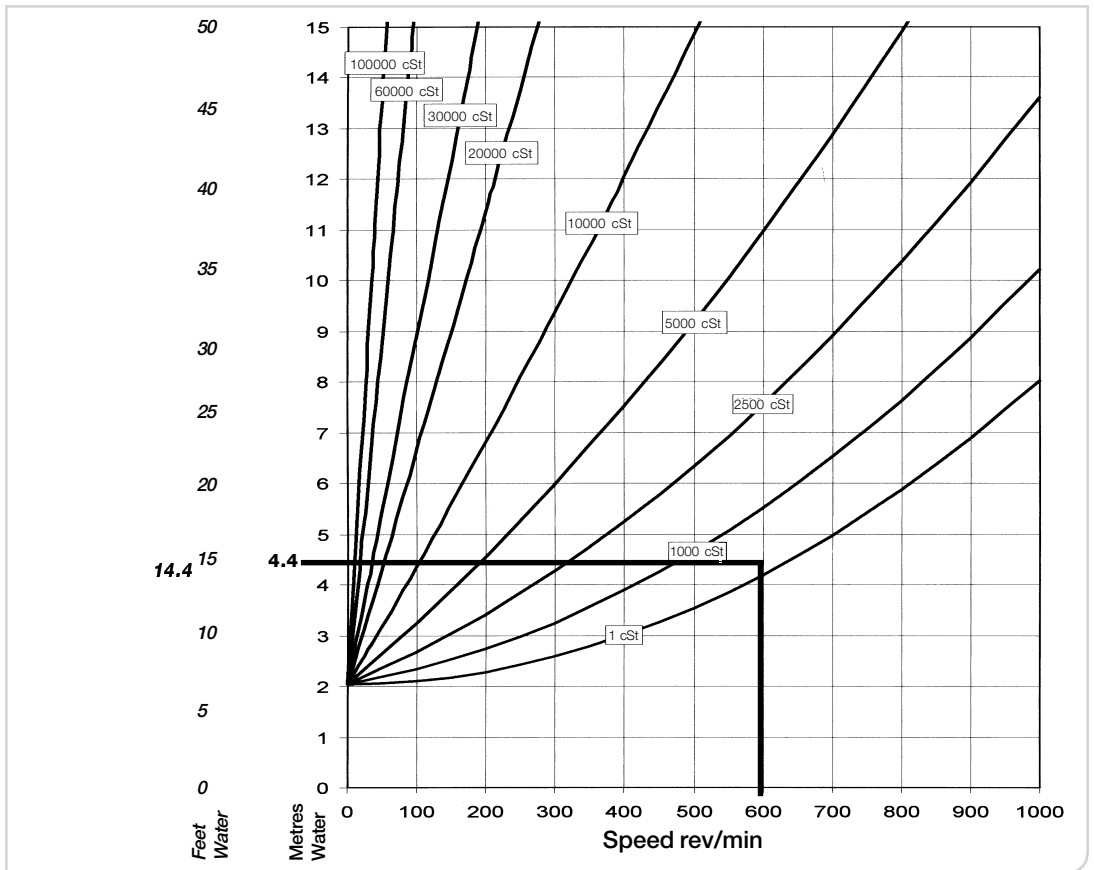

Fig. 7.6.3b SRU2 typical NPSHr curve based on water

From example - at speed 600 rev/min the NPSHr is 4.4 mwc (14.4 ft).

7.6.4 Pumps fitted with Bi-lobe Rotors (Stainless Steel)

These rotors, described in 8.2.1, are mainly used on high viscosity products containing solids where the pumps volumetric efficiency is high. When pumping such products optimum performance is obtained by using large slow running pumps.

Applications on water like viscosity fluids would result in decreased efficiency over stainless steel tri-lobe rotors. For sizing purposes a percentage increase on the 'dead head speed' (see table below) should be applied to the performance curve for stainless steel tri-lobe rotors and interpolated accordingly.

Table 7.6.4a

SRU Pump Model	%age Increase Required on Tri-lobe Rotor Dead Head Speed
SRU1/005	40
SRU1/008	40
SRU2/013	40
SRU2/018	40
SRU3/027	30
SRU3/038	30
SRU4/055	30
SRU4/079	25
SRU5/116	25
SRU5/168	10
SRU6/260	10
SRU6/353	10

Example of How to Interpolate Performance Curve

'X' rev/min represents the 'dead head speed' for tri-lobe rotors to which a percentage increase is applied from the table shown. Pump speed for bi-lobe rotors is found accordingly.

Fig. 7.6.4a Performance curve interpolation

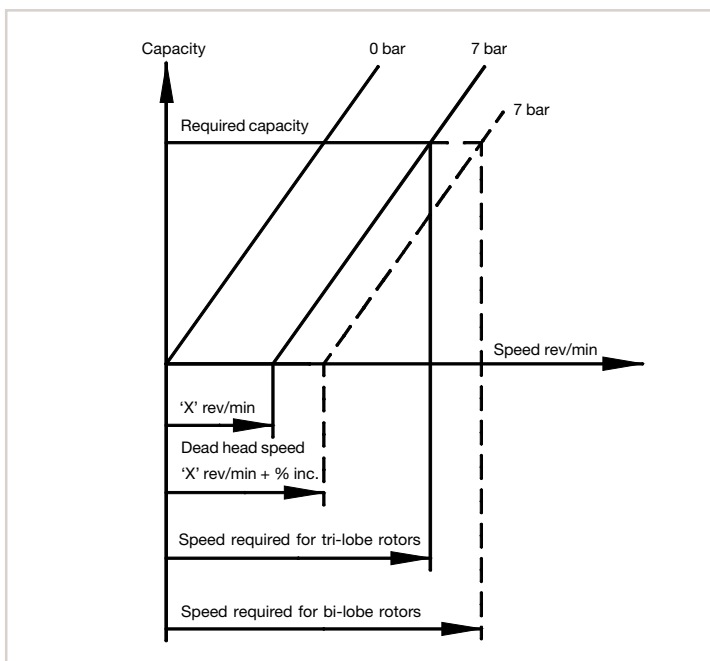

7.6.5 Pumps fitted with Bi-lobe Rotors (Non Galling Alloy)

These rotors, described in 8.2.1, have very small clearances resulting in increased volumetric efficiency over stainless steel rotors when used on fluids with viscosities up to 50 cP. Pump sizing is achieved by referring to published performance curves or a pump selection program. Due to pumphead clearances described in 8.2.2, different performance curves are used for the various temperature ratings of rotors i.e. 70°C (158°F), 130°C (266°F) and 200°C (392°F). The use of performance curves is as described in 7.6.3.

7.6.6 Pumps fitted with Tri-lobe Rubber Covered Rotors

These rotors, described in 8.2.1, have minimal clearance and will therefore significantly improve the pumps volumetric efficiency to approx. 95%. Pump sizing is achieved by referring to published performance curves or a pump selection program. Due to the minimal pumphead clearances described in 8.2.2, there is only one temperature rating of rotors i.e. 70°C (158°F). The use of performance curves is as described in 7.6.3.

7.6.7 Pumps with Electropolished Surface Finish

Pump performance will be affected by electropolish surface finish to the pump head internals. For sizing purposes a percentage increase on the 'dead head speed' (see tables below) should be applied to the performance curve for stainless steel tri-lobe rotors and interpolated accordingly.

Table 7.6.7a

Pump Model SRU range	%age Increase Required on Stainless Steel Tri-lobe Rotor Dead Head Speed	
	Electropolishing only	Mechanical and Electropolishing
1/005	17.0	60.0
1/008	15.1	55.0
2/013	10.8	45.8
2/018	8.5	38.0
3/027	6.7	32.7
3/038	5.5	28.5
4/055	4.6	24.8
4/079	3.8	21.0
5/116	2.9	18.0
5/168	2.4	15.5
6/260	2.0	12.8
6/353	1.7	11.4

Table 7.6.7b

Pump Model SX range	%age Increase Required on Multi-lobe Rotor Dead Head Speed	
	Electropolishing only	Mechanical and Electropolishing
1/005	12.0	60.0
1/007	9.3	47.6
2/013	8.3	40.9
2/018	7.7	38.4
3/027	6.9	34.0
3/035	6.2	31.3
4/046	5.6	28.6
4/063	5.0	25.5
5/082	4.5	22.8
5/116	4.0	19.3
6/140	3.5	17.0
6/190	2.9	14.0
7/250	2.2	11.3
7/380	1.3	6.8

7.6.8 Guidelines for Solids Handling

The following criteria should be considered when deciding the pumps ability to handle large solids in suspension.

		<u>Optimum Conditions</u>
Solids form	-	Spherical
Solids physical properties i.e. - hardness, Resilience, shear strength	-	Soft, yet possess resilience and shear strength
Solids surface finish	-	Smooth
Fluid/solids proportion	-	Proportion of solids to fluid is small
Relationship of fluid/solid SG	-	Equal
Flow velocity (pump speed)	-	Maintained such that solids in suspension are not damaged
Rotor form	-	Bi-lobe
Port size	-	Large as possible

Tables below show the maximum spherical solids size that can be satisfactory handled without product degradation, providing the optimum conditions are met. For non-optimum conditions these should be referred to Alfa Laval.

Table 7.6.8a

SRU Model	Maximum Spherical Solids Size			
	Bi-lobe Rotors		Tri-lobe Rotors	
	mm	in	mm	in
SRU1/005	8	0.31	6	0.24
SRU1/008	8	0.31	6	0.24
SRU2/013	8	0.31	6	0.24
SRU2/018	13	0.51	9	0.34
SRU3/027	13	0.51	9	0.34
SRU3/038	16	0.63	11	0.44
SRU4/055	16	0.63	11	0.44
SRU4/079	22	0.88	15	0.59
SRU5/116	22	0.88	15	0.59
SRU5/168	27	1.06	18	0.72
SRU6/260	27	1.06	18	0.72
SRU6/353	37	1.47	24	0.94

Table 7.6.8b

SX Model	Maximum Spherical Solids Size Multi-lobe Rotors	
	mm	in
SX1/005	7	0.28
SX1/007	7	0.28
SX2/013	10	0.39
SX2/018	10	0.39
SX3/027	13	0.51
SX3/035	13	0.51
SX4/046	16	0.63
SX4/063	16	0.63
SX5/082	19	0.75
SX5/116	19	0.75
SX6/140	25	0.98
SX6/190	25	0.98
SX7/250	28	1.10
SX7/380	28	1.10

7.6.9 Guidelines for Pumping Shear Sensitive Media

Special attention needs to be made to pumping shear sensitive media such as yeast and yoghurt where the cell structure needs to remain intact. Excess pump speed can irreversibly damage the cell structure. Therefore pump speeds need to be kept relatively low, in the range of 100 to 400 rev/min dependent upon the fluid being pumped, pump size/model and rotor form. For these types of applications refer to Alfa Laval.

Before sizing a pump, it will be necessary to determine the total head and NPSHa. The theory, including the different formulae regarding these parameters is more specifically described in 2.2.2 and 2.2.4.

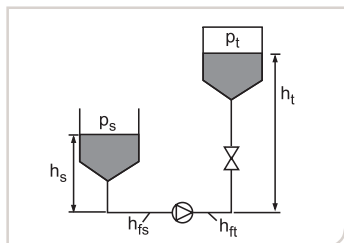

Fig. 7.7b

Total head

Total discharge head $H_t = h_t + h_{ft} + p_t$

- Where h_t = Static head in pressurised vessel.
 h_{ft} = Total pressure drop in discharge line.
 p_t = Pressure in vessel.

- Therefore $h_t = 8 \text{ m} \times (\text{SG} = 1.29) = 10.3 \text{ m}$.
 h_{ft} = Pressure drop in tube Δp_{tube} + Pressure drop in bends and valves Δp (calculated below).
 $p_t = 1 \text{ bar} = 10 \text{ m}$.

To ascertain h_{ft} the flow characteristic and equivalent line length must be determined as follows:

Flow Characteristic

Reynolds number $Re = \frac{D \times V \times \rho}{\mu}$

- where D = tube diameter (mm).
 V = fluid velocity (m/s).
 ρ = density (kg/m³).
 μ = absolute viscosity (cP).

velocity $V = \frac{Q \times 353.6}{D^2}$ where Q = capacity (m³/h).
 D = tube diameter (mm).

$= \frac{9 \times 353.6}{51^2}$

$= 1.22 \text{ m/s}$

density $\rho = 1290$ derived from SG value 1.29 (see 2.1.5).

Therefore $Re = \frac{D \times V \times \rho}{\mu}$

$= \frac{51 \times 1.22 \times 1290}{80}$

$= 1003$

As Re is less than 2300, flow will be laminar.

Equivalent Line Length – Discharge Side

The equivalent lengths of straight tube for bends and valves are taken from table 14.7.1. Since flow is laminar, the viscosity correction factor is 1.0 (see 2.2.2).

Straight tube length	= 3 + 6 + 1	= 10 m
1 bend 90 deg.	= 1 x 1 x 1.0 (corr. factor)	= 1 m
1 butterfly valve	= 1 x 1 x 1.0 (corr. factor)	= 1 m
	Total equivalent length	= 12 m

Also as flow is laminar the friction factor f_D

$$= \frac{64}{Re}$$

$$= \frac{64}{1003}$$

$$= 0.064$$

The Miller equation is now used to determine friction loss as follows:

$$Pf = \frac{5 \times SG \times f_D \times L \times V^2}{D} \quad (\text{bar})$$

Where: P_f = pressure loss due to friction (h_f)
 f_D = friction factor.
 L = tube length (m).
 D = tube diameter (mm).
 V = fluid velocity (m/s).
 SG = specific gravity.

$$= \frac{5 \times 1.29 \times 0.064 \times 12 \times 1.22^2}{51} \quad (\text{bar})$$

$$= 0.14 \text{ bar} = 1.4 \text{ m}$$

$$H_t = h_t + h_{ft} + p_t = 10.3 + 1.4 + 10 \text{ m} = 21.7 \text{ m (2.17 bar)}.$$

$$\text{Total suction head } H_s = h_s - h_{fs} + p_s$$

Where h_s = Static suction head in Tank.
 h_{fs} = Total pressure drop in suction line.
 p_s = Pressure in Tank (open tank).

Therefore $h_s = 2 \text{ m} \times (SG = 1.29) = 2.6 \text{ m}.$
 h_{fs} = Calculated below.
 $p_s = 0$ (open tank).

Equivalent Line Length – Suction Side

The equivalent lengths of straight tube for bends and valves are taken from table 14.7.1. Since flow is laminar, the viscosity correction factor is 1.0 (see 2.2.2).

Straight tube length	= 1 + 1 + 1	= 3 m
2 bend 90 deg.	= 2 x 1 x 1 (corr. factor)	= 2 m
1 non-return valve	= 1 x 12 x 1 (corr. factor)	= 12 m
	Total equivalent length	= 17 m

$$\begin{aligned} \text{Also as flow is laminar the friction factor } f_D &= \frac{64}{\text{Re}} \\ &= \frac{64}{1003} \\ &= 0.064 \end{aligned}$$

The Miller equation is now used to determine friction loss as follows:

$$P_f = \frac{5 \times SG \times f_D \times L \times V^2}{D} \quad (\text{bar})$$

Where:

- Pf = pressure loss due to friction (h_{fs})
- f_D = friction factor.
- L = tube length (m).
- D = tube diameter (mm).
- V = fluid velocity (m/s).
- SG = specific gravity.

$$= \frac{5 \times 1.29 \times 0.064 \times 1.7 \times 1.22^2}{51} \quad (\text{bar})$$

$$= 0.2 \text{ bar} = 2 \text{ m}$$

$$H_s = h_s - h_{fs} + p_s = 2.6 - 2 + 0 \text{ m} = 0.6 \text{ m (0.06 bar)}.$$

$$\text{Total head } H = H_t - H_s = 21.1 - 0.6 = 21.1 \text{ m} \approx 21 \text{ m (2.1 bar)}$$

NPSHa

$$\text{NPSHa} = P_a + h_s - h_{fs} - P_{vp}$$

Where P_a = Pressure absolute above fluid level in Tank.
 h_s = Static suction head in Tank.
 h_{fs} = Total pressure drop in suction line.
 P_{vp} = Vapour pressure of fluid.

Therefore P_a = 1 bar (open tank) = 10 m.
 h_s = 2.6 m.
 h_{fs} = calculated to be 2 m.
 P_{vp} = at temperature of 15° C this is taken as being negligible i.e. 0 bar a = 0 m.

$$\text{NPSHa} = P_a + h_s - h_{fs} - P_{vp} = 10 + 2.6 - 2 - 0 \text{ m} = 10.6 \text{ m.}$$

Actual pump sizing can be made using pump performance curves or a pump selection program. The performance curve selection procedure is more specifically described in 7.6.3.

From the initial suction line sizing curve (see 14.9), a pump with a size 40 mm inlet connection would be required. Although the smallest pump models SR1/008 (with enlarged port), SRU2/013 (with enlarged port) and SRU2/018 (with sanitary port) have 40 mm pump inlet connections, the flow rate required would exceed the pumps speed limit on the performance curve. We have therefore selected a performance curve for the pump model SRU3/027/LS with 130°C rotor clearances due to the CIP requirement, being the next appropriate pump size. Pump sized as follows:

Pump model	-	SRU3/027/LS.
Connection size	-	40 mm.
Speed	-	606 rev/min.
NPSHr	-	3.6 m.

Cavitation check:

NPSHa should be greater than NPSHr i.e. 10.6 m > 3.6 m.

Viscosity/Port Size check:

The viscosity of 80 cP at speed 606 rev/min is well within the pump's maximum rated figures.

Power calculation:

$$\text{Total Required Power (kW)} = \frac{P_v \times \text{Pump speed (rev/min)} + \text{Power at 1 cSt (kW)}}{10000}$$

where P_v = Power/viscosity factor.

From example

- At speed 606 rev/min and total head 2.1 bar, the power at 1 cSt is 0.9 kW,
- At viscosity 80 cP (62 cSt) the P_v factor is 3.

$$\text{Total Required Power (kW)} = \frac{P_v \times \text{Pump speed (rev/min)} + \text{Power at 1 cSt (kW)}}{10000}$$

$$= \frac{3 \times 606 + 0.9}{10000}$$

$$= 1.1 \text{ kW}$$

It should be noted that this is the power needed at the pump shaft, and the appropriate motor power must be selected, which in this instance would be 1.5 kW being the nearest motor output power above the required power.

The recommended type of shaft seal based upon Alfa Laval application experience and guidelines would be a single flushed mechanical seal with tungsten carbide/tungsten carbide faces and EPDM elastomers.

- Hard tungsten carbide seal faces due to the abrasive nature of sugar syrup.
- Flushed version to prevent the sugar syrup from crystallising within the seal area.
- EPDM elastomers for compatibility of both sugar syrup and CIP media.

Pump 2 – Masseurite pump

Fig. 7.7c Pump 2 - example

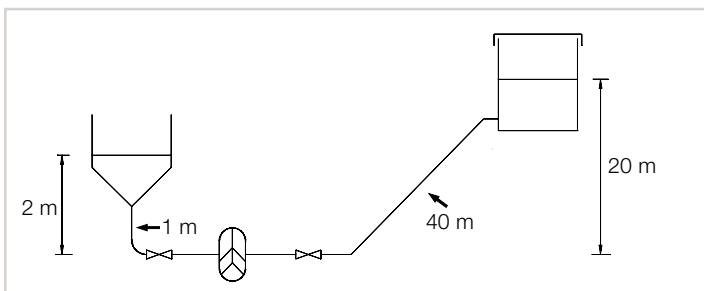

All the data has been given by the customer.

Product/Fluid data:

Fluid to be pumped - Masseurite.
 Viscosity - 25000 cP.
 SG - 1.35
 Pumping temperature - 65°C.

Performance data:

Capacity - 10 m³/h.
 Discharge - via 40 m of 76 mm dia. tube, plus 2 bends 45 deg. and 1 butterfly valve
 Static head in tank = 20 m.
 Suction - via 1 m of 101.6 mm dia. tube, plus 1 bend 90 deg. and 1 butterfly valve.
 Static head in tank = 2 m.

Site Services data:

Electrical supply - 220/380v, 50 Hz.

Before sizing a pump, it will be necessary to determine the total head and NPSHa. The theory, including the different formulae regarding these parameters is more specifically described in 2.2.2 and 2.2.4.

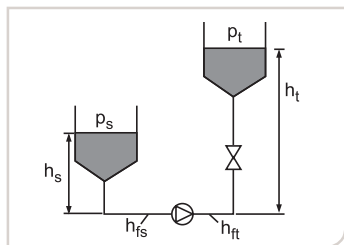

Fig. 7.7d

Total head

Total discharge head $H_t = h_t + h_{ft} + p_t$

- Where h_t = Static head in pressurised vessel.
 h_{ft} = Total pressure drop in discharge line.
 p_t = Pressure in vessel.

- Therefore $h_t = 20 \text{ m} \times (\text{SG} = 1.35) = 27 \text{ m}$.
 h_{ft} = Pressure drop in tube Δp_{tube} + Pressure drop in bends and valves Δp (calculated below).
 $p_t = 0 \text{ bar}$ (open tank) = 0 m.

To ascertain h_{ft} the flow characteristic and equivalent line length must be determined as follows:

Flow Characteristic

Reynolds number $Re = \frac{D \times V \times \rho}{\mu}$

- where D = tube diameter (mm).
 V = fluid velocity (m/s).
 ρ = density (kg/m³).
 μ = absolute viscosity (cP).

velocity $V = \frac{Q \times 353.6}{D^2}$ where Q = capacity (m³/h).
 D = tube diameter (mm).

$= \frac{10 \times 353.6}{76^2}$

$= 0.61 \text{ m/s}$

density $\rho = 1350$ derived from SG value 1.35 (see 2.1.5).

Therefore $Re = \frac{D \times V \times \rho}{\mu}$

$= \frac{76 \times 0.61 \times 1350}{25000}$

$= 2.5$

As Re is less than 2300, flow will be laminar.

Equivalent Line Length – Discharge Side

The equivalent lengths of straight tube for bends and valves are taken from table 14.7.1. Since flow is laminar, the viscosity correction factor is 0.25 (see 2.2.2).

Straight tube length		= 40 m
2 bend 45 deg.	= 2 x 1 x 0.25 (corr. factor)	= 0.5 m
1 butterfly valve	= 1 x 2 x 0.25 (corr. factor)	= 0.5 m
	Total equivalent length	= 41 m

Also as flow is laminar the friction factor f_D

$$= \frac{64}{Re}$$

$$= \frac{64}{2.5}$$

$$= 25.6$$

The Miller equation is now used to determine friction loss as follows:

$$Pf = \frac{5 \times SG \times f_D \times L \times V^2}{D} \quad (\text{bar})$$

Where: P_f = pressure loss due to friction (h_f)
 f_D = friction factor.
 L = tube length (m).
 D = tube diameter (mm).
 V = fluid velocity (m/s).
 SG = specific gravity.

$$= \frac{5 \times 1.35 \times 25.6 \times 41 \times 0.61^2}{76} \quad (\text{bar})$$

$$= 34.7 \text{ bar} = 347 \text{ m}$$

$$H_t = h_t + h_{ft} + p_t = 27 + 347 + 0 \text{ m} = 374 \text{ m (37.4 bar)}.$$

Total suction head $H_s = h_s - h_{fs} + p_s$

Where h_s = Static suction head in Tank.
 h_{fs} = Total pressure drop in suction line.
 p_s = Pressure in Tank (open tank).

Therefore $h_s = 2 \text{ m} \times (SG = 1.35) = 2.7 \text{ m}.$
 h_{fs} = Calculated below.
 $p_s = 0$ (open tank).

To ascertain h_{ts} the flow characteristic and equivalent line length must be determined as follows:

Flow Characteristic

$$\text{Reynolds number } Re = \frac{D \times V \times \rho}{\mu}$$

where D = tube diameter (mm).
 V = fluid velocity (m/s).
 ρ = density (kg/m³).
 μ = absolute viscosity (cP).

$$\begin{aligned} \text{velocity } V &= \frac{Q \times 353.6}{D^2} \quad \text{where } Q = \text{capacity (m}^3/\text{h).} \\ &\qquad\qquad\qquad D = \text{tube diameter (mm).} \\ &= \frac{9 \times 353.6}{101.6^2} \\ &= 0.34 \text{ m/s} \end{aligned}$$

density ρ = 1350 derived from SG value 1.35 (see 2.1.5).

$$\begin{aligned} \text{Therefore } Re &= \frac{D \times V \times \rho}{\mu} \\ &= \frac{101.6 \times 0.34 \times 1350}{25000} \\ &= 1.9 \end{aligned}$$

As Re is less than 2300, flow will be laminar.

Equivalent Line Length – Suction Side

The equivalent lengths of straight tube for bends and valves are taken from table 14.7.1. Since flow is laminar, the viscosity correction factor is 0.25 (see 2.2.2).

$$\begin{aligned}
 \text{Straight tube length} &= 1 \text{ m} \\
 1 \text{ bend } 90 \text{ deg.} &= 1 \times 2 \times 0.25 \text{ (corr. factor)} = 0.5 \text{ m} \\
 1 \text{ butterfly valve} &= 1 \times 2 \times 0.25 \text{ (corr. factor)} = 0.5 \text{ m} \\
 \text{Total equivalent length} &= 2 \text{ m}
 \end{aligned}$$

$$\begin{aligned}
 \text{Also as flow is laminar the friction factor } f_D &= \frac{64}{\text{Re}} \\
 &= \frac{64}{1.9} \\
 &= 33.68
 \end{aligned}$$

The Miller equation is now used to determine friction loss as follows:

$$P_f = \frac{5 \times \text{SG} \times f_D \times L \times V^2}{D} \quad (\text{bar})$$

Where:

- Pf = pressure loss due to friction (h_{fs})
- f_D = friction factor.
- L = tube length (m).
- D = tube diameter (mm).
- V = fluid velocity (m/s).
- SG = specific gravity.

$$= \frac{5 \times 1.35 \times 33.68 \times 2 \times 0.34^2}{101.6} \quad (\text{bar})$$

$$= 0.52 \text{ bar} = 5.2 \text{ m}$$

$$H_s = h_s - h_{fs} + p_s = 2.7 - 5.2 + 0 \text{ m} = -2.5 \text{ m.}$$

$$\text{Total head } H = H_t - H_s = 374 - (-2.5) = 376.5 \text{ m} \approx 377 \text{ m (37.7 bar)}$$

In this example the total head required is in excess of the 20 bar maximum working pressure of the pump. To reduce this head so as a pump can be suitably sized, consideration could be given to any or a combination of the following parameters:

1. Reduce capacity.
2. Increase tube diameter.
3. Increase pumping temperature to reduce viscosity.
4. Consider two or more pumps in series.

Assuming the capacity is a definite requirement and the pumping temperature cannot be increased the customer should be advised to increase the discharge tube diameter i.e. from 76 mm to 101.6 mm.

The total head calculations are reworked, and for this particular example the fluid velocity (V) and friction factor (f_D) have already been established for 101.6 mm diameter tube. Also note, by referring to the equivalent tube length table 14.7.1 the values for bends 45 deg. and butterfly valves remain unchanged.

Using the Miller equation to determine friction loss as follows:

$$P_f = \frac{5 \times SG \times f_D \times L \times V^2}{D} \quad (\text{bar})$$

Where: P_f = pressure loss due to friction (h_f)
 f_D = friction factor.
 L = tube length (m).
 D = tube diameter (mm).
 V = fluid velocity (m/s).
 SG = specific gravity.

$$= \frac{5 \times 1.35 \times 33.68 \times 41 \times 0.34^2}{101.6} \quad (\text{bar})$$

$$= 10.6 \text{ bar} = 106 \text{ m}$$

Now $H_t = h_t + h_f + p_t = 27 + 106 + 0 \text{ m} = 133 \text{ m (13.3 bar)}$.

**Now Total head $H = H_t - H_s = 133 - (-2.5)$
 $= 135.5 \text{ m} \approx 136 \text{ m (13.6 bar)}$**

NPSHa

$NPSHa = P_a + h_s - h_{fs} - Pvp$.

Where P_a = Pressure absolute above fluid level in Tank.
 h_s = Static suction head in Tank.
 h_{fs} = Total pressure drop in suction line.
 Pvp = Vapour pressure of fluid.

Therefore P_a = 1 bar (open tank) = 10 m.
 h_s = 2.7 m.
 h_{fs} = calculated to be 5.2 m.
 Pvp = at temperature of 65 °C this is taken as being negligible i.e. 0 bar a = 0 m.

$$\text{NPSHa} = \text{Pa} + h_s - h_{fs} - \text{Pvp} = 10 + 2.7 - 5.2 - 0 \text{ m} = 7.5 \text{ m.}$$

Due to the high viscosity it is not practical to use pump performance curves for sizing purposes. The actual pump sizing can be made using a pump selection program. An approximate guide to pump sizing can be made by calculation using volumetric efficiency.

For this particular example a pump sized from the pump selection program using stainless steel tri-lobe rotors with 130°C rotor clearances would be as follows:

Pump model	-	SRU5/168/LD.
Connection size	-	100 mm (enlarged port).
Speed	-	100 rev/min.
NPSHr	-	2.1 m.

Cavitation check:

NPSHa should be greater than NPSHr i.e. 7.5 m > 2.1 m.

Viscosity/Port Size check:

The viscosity of 25000 cP at speed 100 rev/min is well within the pump's maximum rated figures.

Power calculation:

$$\text{Total Required Power (kW)} = \frac{\text{Pv} \times \text{Pump speed (rev/min)}}{10000} + \text{Power at 1 cSt (kW)}$$

where Pv = Power/viscosity factor.

From example

- At speed 100 rev/min and total head 13.6 bar, the power at 1 cSt is 4.1 kW,
- at viscosity 25000 cP (18519 cSt) the Pv factor is 110.

$$\text{Total Required Power (kW)} = \frac{\text{Pv} \times \text{Pump speed (rev/min)}}{10000} + \text{Power at 1 cSt (kW)}$$

$$= \frac{110 \times 100}{10000} + 4.1$$

$$= 5.2 \text{ kW}$$

It should be noted that this is the power needed at the pump shaft, and for a fixed speed drive the appropriate motor power must be selected, which in this instance would be 5.5 kW being the nearest motor output power above the required power.

The recommended shaft seal type based upon Alfa Laval application experience and guidelines would be a packed gland arrangement with polyamide gland packing on hard coated shaft sleeves with EPDM elastomers. Alternative shaft sealing could be a flushed packed gland or double flushed mechanical seal.

Alternative Pump Sizing Guide Using Volumetric Efficiency Calculation.

Referring to the initial suction line sizing curve shown in 14.9, for the flow rate required of 10 m³/h with viscosity 25000 cP (18519 cSt), a pump having a 100 mm dia. inlet port would be selected.

For this example a Model SRU5/168 pump will be selected having 100 mm dia. enlarged ports. If a sanitary port is a definite requirement the Model SRU6/260 pump would be selected.

To calculate pump speed for the SRU5/168 pump selected the following formula is used as a general guide with volumetric efficiency of 99% (see 7.2.4).

$$\text{Pump speed (rev/min) } n = \frac{Q \times 100}{q \times \eta_v \times 60}$$

where: Q = capacity (m³/h)
 q = pump displacement (m³/100 rev)
 η_v = vol. efficiency (99% = 0.99)

$$= \frac{10 \times 100}{0.168 \times 0.99 \times 60}$$

$$= 100 \text{ rev/min}$$

7.8 Worked Examples of Rotary Lobe Pump Sizing (US units)

The following examples show two different rotary lobe pumps to be sized for a typical sugar process.

Pump 1 is a low viscosity example handling sugar syrup.
Pump 2 is a high viscosity example handling massecurite.

As described in 7.1 in order to correctly size any type of pump, information is required such as Product/Fluid data, Performance data and Site Services data.

Pump 1 – Thin Sugar Syrup pump

Fig. 7.8a Pump 1 - example

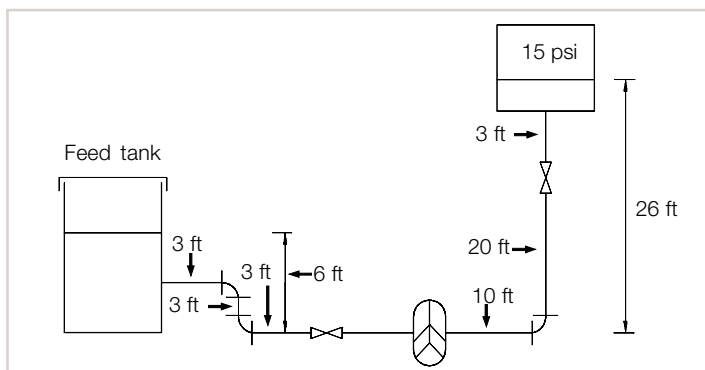

All the data has been given by the customer.

Product/Fluid data:

- Fluid to be pumped - Sugar syrup.
- Viscosity - 62 cSt.
- SG - 1.29.
- Pumping temperature - 59°F.
- CIP temperature - 203°F.

Performance data:

- Capacity - 40 US gall/min.
- Discharge - via 33 ft of 2 in dia. tube, plus 1 bend 90 deg. and 1 butterfly valve.
Static head in vessel = 26 ft.
Pressure in vessel = 15 psi.
- Suction - via 9 ft of 2 in dia. tube, plus 2 bends 90 deg. and 1 non-return valve.
Static head in tank = 6 ft.

Site Services data:

- Electrical supply - 230/460v, 60 Hz.

Before sizing a pump, it will be necessary to determine the total head and NPSHa. The theory, including the different formulae regarding these parameters is more specifically described in 2.2.2 and 2.2.4.

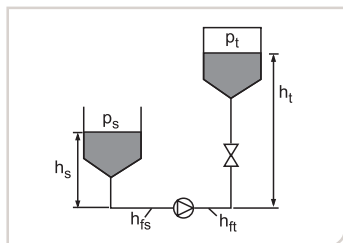

Fig. 7.8b

Total head

Total discharge head $H_t = h_t + h_{ft} + p_t$

- Where h_t = Static head in pressurised vessel.
 h_{ft} = Total pressure drop in discharge line.
 p_t = Pressure in vessel.

- Therefore $h_t = 26 \text{ ft} \times (\text{SG} = 1.29) = 33.5 \text{ ft}$.
 h_{ft} = Pressure drop in tube Δp_{tube} + Pressure drop in bends and valves Δp (calculated below).
 $p_t = 15 \text{ psi} = 35 \text{ ft}$.

To ascertain h_{ft} the flow characteristic and equivalent line length must be determined as follows:

Flow Characteristic

Reynolds number $Re = \frac{3162 \times Q}{D \times v}$

- where D = tube diameter (in).
 Q = capacity (US gall/min).
 v = kinematic viscosity (cSt).

= $\frac{3162 \times 40}{2 \times 62}$

= 1020

As Re is less than 2300, flow will be laminar.

Equivalent Line Length – Discharge Side

The equivalent lengths of straight tube for bends and valves are taken from table 14.7.2. Since flow is laminar, the viscosity correction factor is 1.0 (see 2.2.2).

$$\begin{aligned}
 \text{Straight tube length} &= 10 + 20 + 3 &&= 33 \text{ ft} \\
 1 \text{ bend } 90 \text{ deg.} &= 1 \times 3 \times 1.0 \text{ (corr. factor)} &&= 3 \text{ ft} \\
 1 \text{ butterfly valve} &= 1 \times 3 \times 1.0 \text{ (corr. factor)} &&= 3 \text{ ft} \\
 \text{Total equivalent length} &&&= 39 \text{ ft}
 \end{aligned}$$

$$\begin{aligned}
 \text{Also as flow is laminar the friction factor } f_D &= \frac{64}{\text{Re}} \\
 &= \frac{64}{1020} \\
 &= 0.063
 \end{aligned}$$

The Miller equation is now used to determine friction loss as follows:

$$Pf = \frac{0.0823 \times SG \times f_D \times L \times V^2}{D} \quad (\text{psi})$$

Where: Pf = pressure loss due to friction (h_f)
 f_D = friction factor.
 L = tube length (ft).
 D = tube diameter (in).
 V = fluid velocity (ft/s).
 SG = specific gravity.

$$\begin{aligned}
 \text{Velocity } V &= \frac{Q \times 0.409}{D^2} \text{ where } Q = \text{capacity (US gall/min)} \\
 & \hspace{15em} D = \text{tube diameter (in)} \\
 &= \frac{40 \times 0.409}{2^2} \\
 &= 4.1 \text{ ft/s}
 \end{aligned}$$

$$\begin{aligned}
 Pf &= \frac{0.0823 \times 1.29 \times 0.063 \times 39 \times 4.1^2}{2} \quad (\text{psi}) \\
 &= 2.2 \text{ psi} = 5 \text{ ft}
 \end{aligned}$$

$$H_t = h_t + h_{ft} + p_t = 33.5 + 5 + 35 \text{ ft} = 73.5 \text{ ft} \approx 74 \text{ ft (32 psi)}.$$

$$\text{Total suction head } H_s = h_s - h_{fs} + p_s$$

Where h_s = Static suction head in Tank.
 h_{fs} = Total pressure drop in suction line.
 p_s = Pressure in Tank (open tank).

Therefore h_s = 6 ft x (SG = 1.29) = 7.7 ft.
 h_{fs} = Calculated below.
 p_s = 0 (open tank).

Equivalent Line Length – Suction Side

The equivalent lengths of straight tube for bends and valves are taken from table 14.7.2. Since flow is laminar, the viscosity correction factor is 1.0 (see 2.2.2).

Straight tube length = 3 + 3 + 3 = 9 ft
 2 bend 90 deg. = 2 x 3 x 1 (corr. factor) = 6 ft
 1 non-return valve = 1 x 39 x 1 (corr. factor) = 39 ft
 Total equivalent length = 54 ft

Also as flow is laminar the friction factor f_D = $\frac{64}{Re}$
 = $\frac{64}{1020}$
 = 0.063

The Miller equation is now used to determine friction loss as follows:

$$Pf = \frac{0.0823 \times SG \times f_D \times L \times V^2}{D} \text{ (psi)}$$

Where: Pf = pressure loss due to friction (h_{fs})
 f_D = friction factor.
 L = tube length (ft).
 D = tube diameter (in).
 V = fluid velocity (ft/s).
 SG = specific gravity.

$$\begin{aligned} \text{Velocity } V &= \frac{Q \times 0.409}{D^2} \text{ where } Q = \text{capacity (US gall/min)} \\ & \hspace{10em} D = \text{tube diameter (in)} \\ &= \frac{40 \times 0.409}{2^2} \\ &= 4.1 \text{ ft/s} \end{aligned}$$

$$P_f = \frac{0.0823 \times 1.29 \times 0.063 \times 54 \times 4.1^2}{2} \text{ (psi)}$$

$$= 3 \text{ psi} = 7 \text{ ft}$$

$$H_s = h_s - h_{fs} + p_s = 7.7 - 7 + 0 \text{ ft} = 0.7 \text{ ft (0.3 psi)}.$$

$$\text{Total head } H = H_t - H_s = 74 - 0.7 = 73.3 \text{ ft} \approx 73 \text{ ft (32 psi)}.$$

NPSHa

$$\text{NPSHa} = P_a + h_s - h_{fs} - P_{vp}.$$

Where P_a = Pressure absolute above fluid level in Tank.
 h_s = Static suction head in Tank.
 h_{fs} = Total pressure drop in suction line.
 P_{vp} = Vapour pressure of fluid.

Therefore P_a = 14.7 psi (open tank) = 33.9 ft.
 h_s = 7.7 ft.
 h_{fs} = calculated to be 7 ft.
 P_{vp} = at temperature of 59° F this is taken as being negligible i.e. 0 psia = 0 ft.

$$\text{NPSHa} = P_a + h_s - h_{fs} - P_{vp} = 33.9 + 7.7 - 7 - 0 \text{ ft} = 34.6 \text{ ft}.$$

Actual pump sizing can be made using pump performance curves or a pump selection program. The performance curve selection procedure is more specifically described in 7.6.3.

From the initial suction line sizing curve (see 14.9), a pump with a size 1.5 in inlet connection would be required. Although the smallest pump models SR1/008 (with enlarged port), SRU2/013 (with enlarged port) and SRU2/018 (with sanitary port) have 1.5 in pump inlet connections, the flow rate required would exceed the pumps speed limit on the performance curve. We have therefore selected a performance curve for the pump model SRU3/027/LS with 266°F rotor clearances due to the CIP requirement, being the next appropriate pump size. Pump sized as follows:

Pump model - SRU3/027/LS.
 Connection size - 1.5 in.
 Speed - 613 rev/min.
 NPSHr - 11.9 ft.

Cavitation check:

NPSHa should be greater than NPSHr i.e. 34.6 ft > 11.9 ft.

Viscosity/Port Size check:

The viscosity of 62 cSt at speed 613 rev/min is well within the pump's maximum rated figures.

Power calculation:

$$\text{Total Required Power (kW)} = \frac{P_v \times \text{Pump speed (rev/min)} + \text{Power at 1 cSt (kW)}}{10000}$$

where P_v = Power/viscosity factor.

From example

- At speed 613 rev/min and total head 32 psi, the power at 1 cSt is 1.2 hp,
- At viscosity 62 cSt the P_v factor is 3.

$$\text{Total Required Power (kW)} = \frac{P_v \times \text{Pump speed (rev/min)} + \text{Power at 1 cSt (kW)}}{10000}$$

$$= \frac{3 \times 613 + 1.2}{10000}$$

$$= 1.4 \text{ hp}$$

It should be noted that this is the power needed at the pump shaft, and the appropriate motor power must be selected, which in this instance would be 2 hp being the nearest motor output power above the required power.

The recommended type of shaft seal based upon Alfa Laval application experience and guidelines would be a single flushed mechanical seal with tungsten carbide/tungsten carbide faces and EPDM elastomers.

- Hard tungsten carbide seal faces due to the abrasive nature of sugar syrup.
- Flushed version to prevent the sugar syrup from crystallising within the seal area.
- EPDM elastomers for compatibility of both sugar syrup and CIP media.

Pump 2 – Masseurite pump

Fig. 7.8c Pump 2 - example

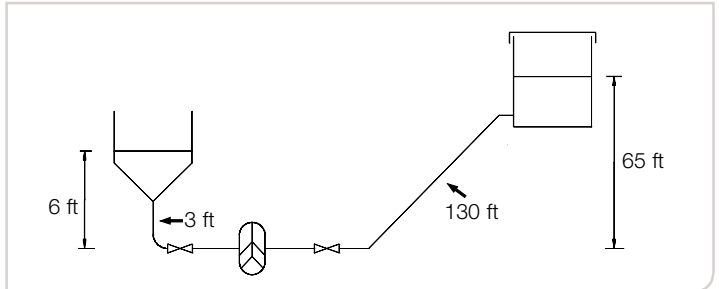

All the data has been given by the customer.

Product/Fluid data:

Fluid to be pumped - Masseurite.
 Viscosity - 18519 cSt.
 SG - 1.35
 Pumping temperature - 149°F.

Performance data:

Capacity - 44 US gall/min.
 Discharge - via 130 ft of 3 in dia. tube, plus 2 bends 45 deg. and 1 butterfly valve
 Static head in tank = 65 ft.
 Suction - via 3 ft of 4 in dia. tube, plus 1 bend 90 deg. and 1 butterfly valve.
 Static head in tank = 6 ft.

Site Services data:

Electrical supply - 230/460v, 60 Hz.

Before sizing a pump, it will be necessary to determine the total head and NPSHa. The theory, including the different formulae regarding these parameters is more specifically described in 2.2.2 and 2.2.4.

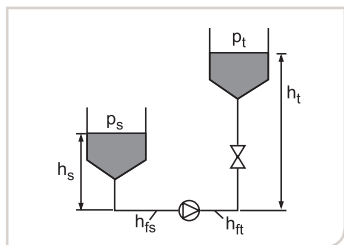

Fig. 7.8d

Total head

Total discharge head $H_t = h_t + h_{ft} + p_t$

- Where h_t = Static head in pressurised vessel.
 h_{ft} = Total pressure drop in discharge line.
 p_t = Pressure in vessel.

- Therefore $h_t = 65 \text{ ft} \times (\text{SG} = 1.35) = 88 \text{ ft.}$
 h_{ft} = Pressure drop in tube Δp_{tube} + Pressure drop in bends and valves Δp (calculated below).
 $p_t = 0 \text{ psi (open tank)} = 0 \text{ ft.}$

To ascertain h_{ft} the flow characteristic and equivalent line length must be determined as follows:

Flow Characteristic

Reynolds number $Re = \frac{3162 \times Q}{D \times \nu}$

- where D = tube diameter (in).
 Q = capacity (US gall/min).
 ν = kinematic viscosity (cSt).

= $\frac{3162 \times 44}{3 \times 18519}$
 = 2.5

As Re is less than 2300, flow will be laminar.

Equivalent Line Length – Discharge Side

The equivalent lengths of straight tube for bends and valves are taken from table 14.7.2. Since flow is laminar, the viscosity correction factor is 0.25 (see 2.2.2).

$$\begin{aligned}
 \text{Straight tube length} &= 130 \text{ ft} \\
 2 \text{ bend } 45 \text{ deg.} &= 2 \times 3 \times 0.25 \text{ (corr. factor)} = 1.5 \text{ ft} \\
 1 \text{ butterfly valve} &= 1 \times 7 \times 0.25 \text{ (corr. factor)} = 1.75 \text{ ft} \\
 \text{Total equivalent length} &= 133 \text{ ft}
 \end{aligned}$$

$$\begin{aligned}
 \text{Also as flow is laminar the friction factor } f_D &= \frac{64}{\text{Re}} \\
 &= \frac{64}{2.5} \\
 &= 25.6
 \end{aligned}$$

The Miller equation is now used to determine friction loss as follows:

$$Pf = \frac{5 \times SG \times f_D \times L \times V^2}{D} \quad (\text{psi})$$

Where: Pf = pressure loss due to friction (h_f)
 f_D = friction factor.
 L = tube length (ft).
 D = tube diameter (in).
 V = fluid velocity (ft/s).
 SG = specific gravity.

$$\begin{aligned}
 \text{Velocity } V &= \frac{Q \times 0.409}{D^2} \text{ where } Q = \text{capacity (US gall/min)} \\
 & \qquad \qquad \qquad D = \text{tube diameter (in)} \\
 &= \frac{40 \times 0.409}{3^2} \\
 &= 2 \text{ ft/s}
 \end{aligned}$$

$$\begin{aligned}
 Pf &= \frac{0.0823 \times 1.35 \times 25.6 \times 133 \times 2^2}{3} \quad (\text{psi}) \\
 &= 504 \text{ psi} = 1163 \text{ ft}
 \end{aligned}$$

$$H_t = h_t + h_f + p_t = 88 + 1163 + 0 \text{ ft} = 1251 \text{ ft (542 psi)}.$$

$$\text{Total suction head } H_s = h_s - h_{fs} + p_s$$

Where h_s = Static suction head in Tank.
 h_{fs} = Total pressure drop in suction line.
 p_s = Pressure in Tank (open tank).

Therefore h_s = 6 ft x (SG = 1.35) = 8 ft.
 h_{fs} = Calculated below.
 p_s = 0 (open tank).

To ascertain h_{fs} the flow characteristic and equivalent line length must be determined as follows:

Flow Characteristic

$$\text{Reynolds number } Re = \frac{3162 \times Q}{D \times \nu}$$

where D = tube diameter (in).
 Q = capacity (US gall/min).
 ν = kinematic viscosity (cSt).

$$= \frac{3162 \times 44}{4 \times 18519}$$

$$= 1.9$$

As Re is less than 2300, flow will be laminar.

Equivalent Line Length – Suction Side

The equivalent lengths of straight tube for bends and valves are taken from table 14.7.2. Since flow is laminar, the viscosity correction factor is 0.25 (see 2.2.2).

Straight tube length		= 3 ft
1 bend 90 deg.	= 1 x 7 x 0.25 (corr. factor)	= 1.75 ft
1 butterfly valve	= 1 x 7 x 0.25 (corr. factor)	= 1.75 ft
	Total equivalent length	= 6.5 ft

Also as flow is laminar the friction factor f_D = $\frac{64}{Re}$

$$= \frac{64}{1.9}$$

$$= 33.68$$

The Miller equation is now used to determine friction loss as follows:

$$Pf = \frac{0.0823 \times SG \times f_D \times L \times V^2}{D} \quad (\text{psi})$$

Where: Pf = pressure loss due to friction (h_s)
 f_D = friction factor.
 L = tube length (ft).
 D = tube diameter (in).
 V = fluid velocity (ft/s).
 SG = specific gravity.

$$\begin{aligned} \text{Velocity } V &= \frac{Q \times 0.409}{D^2} \text{ where } Q = \text{capacity (US gall/min)} \\ & \qquad \qquad \qquad D = \text{tube diameter (in)} \\ &= \frac{44 \times 0.409}{4^2} \\ &= 1.1 \text{ ft/s} \end{aligned}$$

$$\begin{aligned} Pf &= \frac{0.0823 \times 1.35 \times 33.68 \times 6.5 \times 1.1^2}{4} \quad (\text{psi}) \\ &= 7.4 \text{ psi} = 17 \text{ ft} \end{aligned}$$

$$H_s = h_s - h_{fs} + p_s = 8 - 17 + 0 \text{ ft} = -9 \text{ ft.}$$

$$\text{Total head } H = H_t - H_s = 1251 - (-9) = 1260 \text{ ft (546 psi)}$$

In this example the total head required is in excess of the 290 psi maximum working pressure of the pump. To reduce this head so as a pump can be suitably sized, consideration could be given to any or a combination of the following parameters:

1. Reduce capacity.
2. Increase tube diameter.
3. Increase pumping temperature to reduce viscosity.
4. Consider two or more pumps in series.

Assuming the capacity is a definite requirement and the pumping temperature cannot be increased the customer should be advised to increase the discharge tube diameter i.e. from 3 in to 4 in.

The total head calculations are reworked, and for this particular example the fluid velocity (V) and friction factor (f_D) have already been established for 4 in diameter tube. Also note, by referring to the equivalent tube length table 14.7.2 the values for bends 45 deg. and butterfly valves remain unchanged.

Using the Miller equation to determine friction loss as follows:

$$Pf = \frac{0.0823 \times SG \times f_D \times L \times V^2}{D} \quad (\text{psi})$$

Where: Pf = pressure loss due to friction (h_f)
 f_D = friction factor.
 L = tube length (ft).
 D = tube diameter (in).
 V = fluid velocity (ft/s).
 SG = specific gravity.

$$= \frac{0.0823 \times 1.35 \times 33.68 \times 133 \times 1.1^2}{4} \quad (\text{psi})$$

$$= 150 \text{ psi} = 346 \text{ ft}$$

$$\text{Now } H_t = h_t + h_f + p_t = 88 + 346 + 0 \text{ ft} = 434 \text{ ft (188 psi).}$$

$$\text{Now Total head } H = H_t - H_s = 434 - (-9) = 443 \text{ ft (192 psi).}$$

NPSHa

$$\text{NPSHa} = Pa + h_s - h_{fs} - Pvp .$$

Where Pa = Pressure absolute above fluid level in Tank.
 h_s = Static suction head in Tank.
 h_{fs} = Total pressure drop in suction line.
 Pvp = Vapour pressure of fluid.

Therefore Pa = 14.7 psi (open tank) = 33.9 ft.
 h_s = 8 ft.
 h_{fs} = calculated to be 17 ft.
 Pvp = at temperature of 149° F this is taken as being negligible i.e. 0 psia = 0 ft.

$$\text{NPSHa} = Pa + h_s - h_{fs} - Pvp = 33.9 + 8 - 17 - 0 \text{ m} = 24.9 \text{ ft.}$$

Due to the high viscosity it is not practical to use pump performance curves for sizing purposes. The actual pump sizing can be made using a pump selection program. An approximate guide to pump sizing can be made by calculation using volumetric efficiency.

For this particular example a pump sized from the pump selection program using stainless steel tri-lobe rotors with 266° F rotor clearances would be as follows:

Pump model	-	SRU5/168/LD.
Connection size	-	4 in (enlarged port).
Speed	-	100 rev/min.
NPSHr	-	6.9 ft.

Cavitation check:

NPSHa should be greater than NPSHr i.e. 24.9 ft > 6.9 ft.

Viscosity/Port Size check:

The viscosity of 18519 cSt at speed 100 rev/min is well within the pump's maximum rated figures.

Power calculation:

$$\text{Total Required Power (hp)} = \frac{P_v \times \text{Pump speed (rev/min)} + \text{Power at 1 cSt (hp)}}{10000}$$

where P_v = Power/viscosity factor.

From example

- At speed 100 rev/min and total head 192 psi, the power at 1 cSt is 5.5 hp,
- At viscosity 18519 cSt the P_v factor is 110.

$$\text{Total Required Power (hp)} = \frac{P_v \times \text{Pump speed (rev/min)} + \text{Power at 1 cSt (hp)}}{10000}$$

$$= \frac{110 \times 100}{10000} + 5.5$$

$$= 6.6 \text{ hp}$$

It should be noted that this is the power needed at the pump shaft, and for a fixed speed drive the appropriate motor power must be selected, which in this instance would be 7.5 hp being the nearest motor output power above the required power.

The recommended shaft seal type based upon Alfa Laval application experience and guidelines would be a packed gland arrangement with polyamide gland packing on hard coated shaft sleeves with EPDM elastomers. Alternative shaft sealing could be a flushed packed gland or double flushed mechanical seal.

Alternative Pump Sizing Guide Using Volumetric Efficiency Calculation.

Referring to the initial suction line sizing curve shown in 14.9, for the flow rate required of 44 US gall/min with viscosity 18519 cSt, a pump having a 4 in dia. inlet port would be selected.

For this example a Model SRU5/168 pump will be selected having 4 in dia. enlarged ports. If a sanitary port is a definite requirement the Model SRU6/260 would be selected.

To calculate pump speed for the SRU5/168 pump selected the following formula is used as a general guide with volumetric efficiency of 99% (see 7.2.4).

$$\text{Pump speed (rev/min) } n = \frac{Q \times 100}{q \times \eta_v}$$

where: Q = capacity (US gall/min)
 q = pump displacement (US gall/100 rev)
 η_v = vol. efficiency (99% = 0.99)

$$= \frac{44 \times 100}{44.39 \times 0.99}$$

$$= 100 \text{ rev/min}$$

8. Pump Specification Options

This section gives detailed descriptions of the various specification options available for the Alfa Laval pump ranges, such as port connections, heating/cooling jackets, pressure relief valves and other ancillaries.

8.1 Centrifugal and Liquid Ring Pumps

8.1.1 Port Connections

Pumps are supplied with screwed male connections of all major standards, i.e.: SMS, DIN, ISO, BS, DS, GC-clamp, bevel seat, DC and H-line.

Pump Range	Pump Model	Nominal Connection Size			
		Inlet mm	Outlet mm	Inlet in	Outlet in
LKH	LKH-5	50	40	2	1.5
	LKH-10	65	50	2.5	2
	LKH-15	100	80	4	3
	LKH-20	65	50	2.5	2
	LKH-25	80	65	3	2.5
	LKH-35	65	50	2.5	2
	LKH-40	80	65	3	2.5
	LKH-45	100	80	4	3
	LKH-50	100	80	4	3
	LKH-60	100	100	4	4
	LKH-70	100	80	4	3
LKH-80	150	100	6	4	
LKH-Multistage	LKH-112	50	40	2	1.5
	LKH-113	50	40	2	1.5
	LKH-114	50	40	2	1.5
	LKH-122	80	65	3	2.5
	LKH-123	80	65	3	2.5
	LKH-124	80	65	3	2.5
LKHP	LKHP-10	65	50	2.5	2
	LKHP-15	100	80	4	3
	LKHP-20	65	50	2.5	2
	LKHP-25	80	65	3	2.5
	LKHP-35	65	50	2.5	2
	LKHP-40	80	65	3	2.5
	LKHP-45	100	80	4	3
	LKHP-50	100	80	4	3
LKHP-60	100	100	4	4	

Pump Range	Pump Model	Nominal Connection Size			
		Inlet mm	Outlet mm	Inlet in	Outlet in
LKHSP	LKHSP-10	65	50	2.5	2
	LKHSP-20	65	50	2.5	2
	LKHSP-25	80	65	3	2.5
	LKHSP-35	65	50	2.5	2
	LKHSP-40	80	65	3	2.5
LKHI	LKHI-10	65	50	2.5	2
	LKHI-15	100	80	4	3
	LKHI-20	65	50	2.5	2
	LKHI-25	80	65	3	2.5
	LKHI-35	65	50	2.5	2
	LKHI-40	80	65	3	2.5
	LKHI-45	100	80	4	3
	LKHI-50	100	80	4	3
	LKHI-60	100	100	4	4
LKH-UltraPure	LKH-10	65	50	2.5	2
	LKH-20	65	50	2.5	2
	LKH-25	80	65	3	2.5
	LKH-35	65	50	2.5	2
	LKH-40	80	50	3	2
MR	MR-166S	50	50	2	2
	MR-185S	80	80	3	3
	MR-200S	80	80	3	3
	MR-300	80	80	3	3

Table 8.1.1a

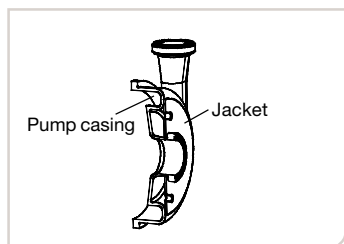

Fig. 8.1.2a Heating/Cooling jacket

8.1.2 Heating/Cooling Jackets

In some applications heating of the fluid being pumped may be required to reduce the fluid viscosity so that satisfactory operation is achieved. Alternatively it may be necessary to cool the fluid being pumped where heat is generated by means of the fluid repeatedly being passed through the pump. On such occasions some pump models can be fitted with heating/cooling jackets.

8.1.3 Pump Casing with Drain

In some applications it is a requirement that no fluid should be left in the pump casing. This can be achieved by either:

- Turning the pump outlet downwards

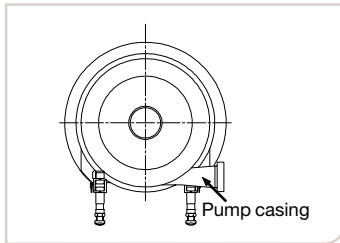

Fig. 8.1.3a Turned pump casing

- Fitting a drain connection to the bottom of the pump casing

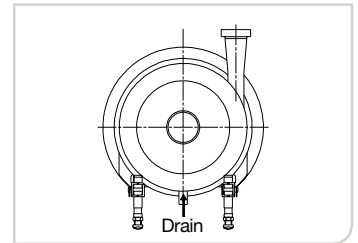

Fig. 8.1.3b Pump casing with drain

or

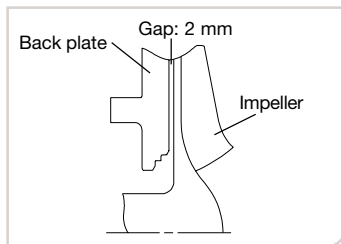

Fig. 8.1.4a Increased gap

8.1.4 Increased Impeller Gap

In some applications, e.g. when using a LKH centrifugal pump as a booster pump in a cream pasteurisation unit, there is a risk that a hard layer of proteins will slowly build up between the backside of the impeller and the back plate. This will activate the thermal relay of the motor after a few hours of operation so that the pump stops.

The operating time of the pump can be increased by increasing the standard gap width between the back of the impeller and the back plate, from 0.5 mm to 2.5 mm. The gap is achieved by machining the back of the impeller. This increased gap reduces the head by approx. 5%.

For this type of application it is recommended to select a motor size with an output power one step higher than the standard selection so as to avoid the motor thermal relay being constantly activated.

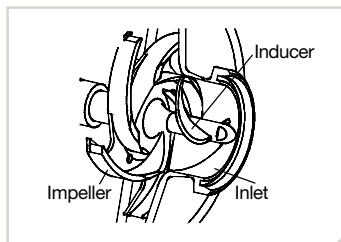

Fig. 8.1.5a Inducer in pump inlet

8.1.5 Pump Inlet Inducer

In some applications it may be necessary to improve the suction conditions by means of fitting the pump inlet with an inducer. This has the effect of improving NPSH requirements for difficult applications and/or assisting the flow of a viscous fluid into the pump casing.

8.2 Rotary Lobe Pumps

8.2.1 Rotor Form

Table 8.2.1a

Rotor Form	Material	Pump Range	
		SRU	SX
Tri-lobe	Stainless steel	✓	
Tri-lobe	Rubber covered	✓	
Bi-lobe	Stainless steel	✓	
Bi-lobe	Non galling alloy	✓	
Multi-lobe	Stainless steel		✓

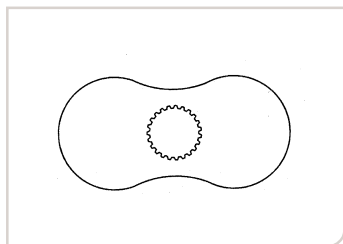

Fig. 8.2.1a Bi-lobe

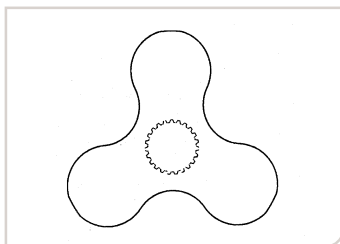

Fig. 8.2.1b Tri-lobe

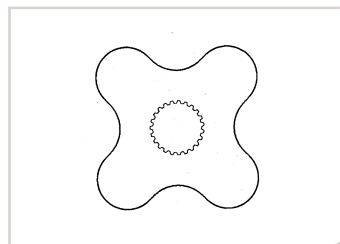

Fig. 8.2.1c Multi-lobe

Tri-lobe Rotors (Stainless steel)

Most duties can be accomplished by pumps fitted with stainless steel tri-lobe rotors. The tri-lobe rotor with its mathematically correct profile and precision manufacture ensure interchangeability as well as smooth, high performance pumping action.

These are available on the SRU pump range with 3 temperature ratings:

- up to 70°C (158°F).
- up to 130°C (266°F).
- up to 200°C (392°F).

and pressures up to 20 bar (290 psig).

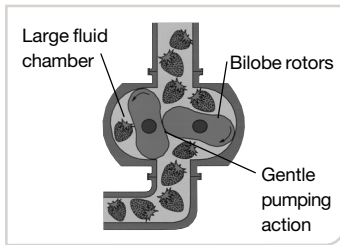

Fig. 8.2.1d Bi-lobe rotors for solids handling

Bi-lobe Rotors (Stainless steel)

These are generally used for handling delicate suspended solids where minimum product damage is required. Typical applications are jam containing fruit pieces, sausage meat filling, petfood, soups and sauces containing solid matter.

These are available on the SRU pump range with 3 temperature ratings:

- up to 70°C (158°F).
- up to 130°C (266°F).
- up to 200°C (392°F).

and pressures up to 20 bar (290 psig).

Bi-lobe Rotors (Non galling alloy)

Manufactured from non-galling alloy these rotors have an advantage over stainless steel, as smaller clearances (see 8.2.2) can be used, leading to increased efficiencies.

These are available on the SRU pump range with 3 temperature ratings:

- up to 70°C (158°F).
- up to 130°C (266°F).
- up to 200°C (392°F).

and pressures up to 20 bar (290 psig).

Tri-lobe Rubber Covered Rotors

This rotor has a stainless steel insert covered in NBR rubber, and due to the resilience of the rubber coating these rotors have a slight interference fit with the pump rotorcase when initially fitted. This results in improved pump performance and suction lift capability over stainless steel tri-lobe rotors.

Rotors are suitable for continuous operation up to 70°C (158°F) and intermittent operation up to 100°C (212°F), and pressures up to 7 bar (100 psig).

Multi-lobe Rotors

This rotor is manufactured from stainless steel and as the name suggests has many lobes. For the SX pump range these rotors have 4 lobes and are designed to maximise efficiency, reduce shear and provide a smooth pumping action. Rotors are suitable for temperatures up to 150°C (302°F) and pressures up to 15 bar (215 psig).

Clearances are necessary to avoid rotor to rotor, rotor to rotorcase and rotor to rotorcase cover contact. The size of these clearances is related to the pressure and temperature of pump operation and rotor material.

8.2.2 Clearances

Within the pump head are clearances, which are the spaces between rotating components and between rotating and stationary components. The key clearances are as follows:

- Radial clearance (between rotor tip and rotorcase).
- Mesh clearance (between rotors).
- Front clearance (between front of rotor and rotorcase cover).
- Back clearance (between back of rotor and back face of rotorcase).

Fig. 8.2.2a Clearances

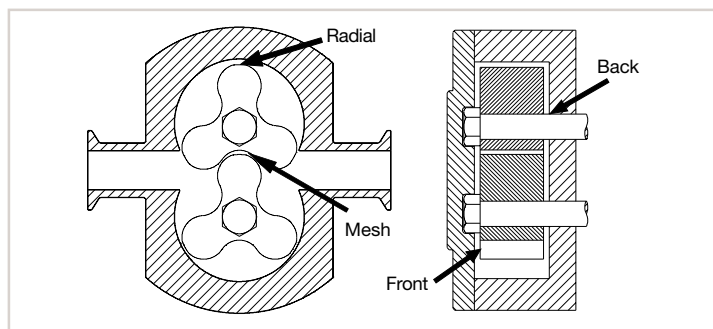

Pressure effect

The design concept of the rotary lobe pump is to have no contacting parts in the pumphead. This requires having the shaft support bearings to be mounted outside of the pumphead, which results in an overhung load, caused by the rotors fitted to the shafts (see Fig. 8.2.2b). The effect of pressure on the rotors will cause shaft deflection, which could result in contact between rotors, rotorcase and rotorcase cover. As product wetted parts of the SRU and SX pump ranges are predominantly manufactured from stainless steel, any contact between rotating and stationary parts would cause 'galling' and possible pump seizure. To allow for this pressure effect, clearances are built into the pumphead between surfaces that may contact. For the SRU and SX pump ranges there is only one pressure rating, which is the maximum differential pressure of the particular pump model. The pressure effect is less significant on pumps fitted with rubber covered or non-galling alloy rotors.

Fig. 8.2.2b Pressure effect

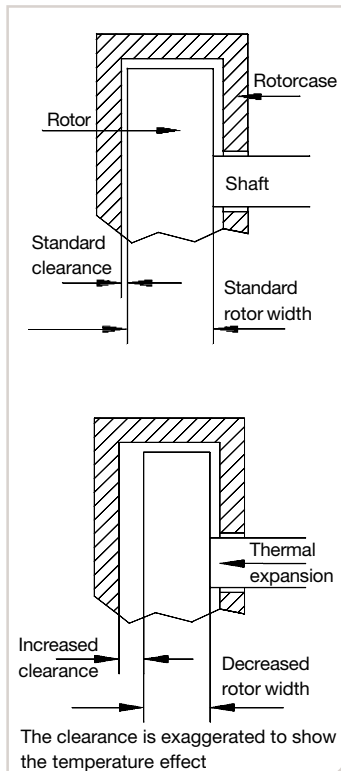
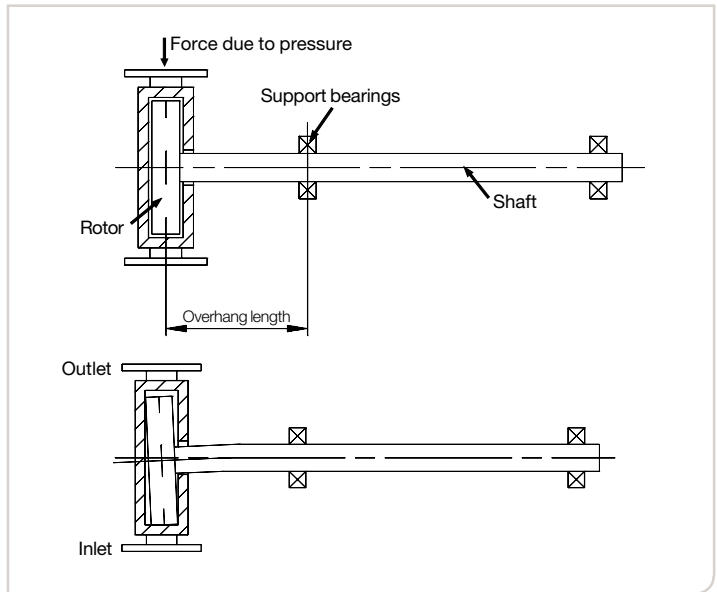

Fig. 8.2.2c Increased clearance

Temperature effect

Temperature change can be caused by the fluid being pumped, pump mechanism, drive unit and/or the environment. Any CIP operation required should also be taken into consideration (see section 10 for detailed explanation of CIP). Changes in temperature will cause expansion upon heating or contraction upon cooling, to the rotorcase and gearcase components. The most significant result is movement between shaft and gearcase/rotorcase causing the rotors to move forward/backward in the rotorcase, thereby reducing the front clearance. To compensate for this, the SRU pump range has increased clearances as shown below. SRU pumps are designed for various temperature ratings for rotors i.e. 70°C (158°F), 130°C (266°F) or 200°C (392°F). On the SX pump range the design of the mechanical seal eliminates contact between the fluid being pumped and the shaft. This results in the shaft not being subjected to the full temperature variation and therefore only one temperature rating of 150°C (302°F) is necessary.

8.2.3 Port Connections

Pumps are supplied with screwed male connections to all major standards as follows:

Table 8.2.3a

Standard Screwed Connection Type	Pump Range	
	SRU	SX
3A/Acme	✓	
BSP	✓	
BSPT	✓	
DIN11851/405	✓	✓
ISS/IDF	✓	✓
NPT	✓	
RDG	✓	
RJT	✓	✓
SMS	✓	✓
Tri-Clamp (BS4825)	✓	✓

All models in the SRU and SX pump ranges are supplied with full bore through porting, conforming to International Sanitary Standards BS4825 / ISO2037. This provides effective CIP cleaning and maximises inlet and outlet port efficiency and NPSHr characteristics. The option of the enlarged port on the SRU pump range can be chosen for high viscosity applications.



Fig. 8.2.3a Sanitary port design

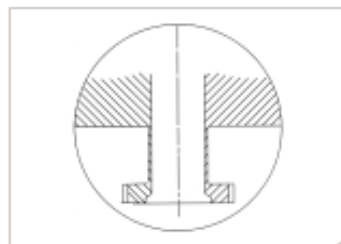

Fig. 8.2.3b Enlarged port design

The SRU pump range when having enlarged ports can also be supplied with flanged connections of all major standards i.e. ASA/ANSI125, ASA/ANSI150, ASA/ANSI300, BS10 table E, BS10 table F, BS4504/DIN2533 and JIS10K.

Flanges for vertically ported pumps are not fitted directly to the discharge port. In this instance an elbow bend is included to which the flange is fitted.

Pump Range	Pump Model	Nominal Connection Size			
		Sanitary		Enlarged	
		mm	in	mm	in
SRU	SRU1/005	25	1	-	-
	SRU1/008	25	1	40	1.5
	SRU2/013	25	1	40	1.5
	SRU2/018	40	1.5	50	2
	SRU3/027	40	1.5	50	2
	SRU3/038	50	2	65	2.5
	SRU4/055	50	2	65	2.5
	SRU4/079	65	2.5	80	3
	SRU5/116	65	2.5	80	3
	SRU5/168	80	3	100	4
	SRU6/260	100	4	100	4
	SRU6/353	100	4	150	6
SX	SX1/005	25	1		
	SX1/007	40	1.5		
	SX2/013	40	1.5		
	SX2/018	50	2		
	SX3/027	50	2		
	SX3/035	65	2.5		
	SX4/046	50	2		
	SX4/063	65	2.5		
	SX5/082	65	2.5		
	SX5/115	80	3		
	SX6/140	80	3		
	SX6/190	100	4		
	SX7/250	100	4		
	SX7/380	150	6		

For size 150 mm (6 in) screwed male connections, these are only available as DIN11851/405, SRJT or Tri-Clamp (BS4825).

Table 8.2.3b

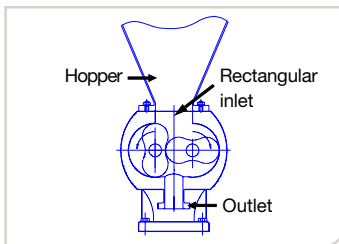

Fig. 8.2.4a Rectangular inlets

8.2.4 Rectangular Inlets

For handling extremely viscous products and/or large solids that would naturally bridge a smaller port, SRU rotary lobe pumps can be supplied with a rectangular inlet. Usually the pump will be in vertical port orientation to allow the product to flow into the pumping chamber under gravity from a hopper mounted directly above or mounted with an adaptor to facilitate connection to large diameter pipework.

As can be seen from the table below there is a significant percentage area increase when using a rectangular inlet compared to a sanitary port connection. This increases the pumps ability to handle highly viscous products.

Table 8.2.4a

Pump Model	Sanitary port area (mm ²)	Rectangular inlet area (mm ²)	% area increase above sanitary port diameter
SRU1/005	387	660	171
SRU1/008	387	1260	326
SRU2/013	387	1216	314
SRU2/018	957	1976	206
SRU3/027	957	2112	221
SRU3/038	1780	3360	189
SRU4/055	1780	2688	151
SRU4/079	2856	4320	151
SRU5/116	2856	5032	176
SRU5/168	4185	8160	195
SRU6/260	7482	13888	186
SRU6/353	7482	18240	244

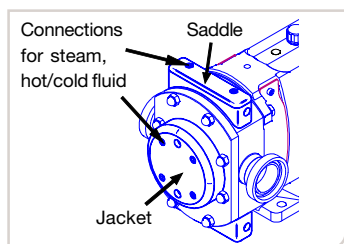

Fig. 8.2.5a Heating/Cooling jackets and saddles

8.2.5 Heating/Cooling Jackets and Saddles

Rotary Lobe pumps can be fitted with jackets to the rotorcase cover and saddles to the rotorcase. These are primarily used for warming the pumphead so as to prevent the fluid pumped being cooled and become viscous or allowed to solidify/crystallise. These can also be used for cooling purposes.

The maximum pressure and temperature of heating/cooling fluid is 3.5 bar (50 psig) and 150°C (302°F) respectively. Heating/cooling jackets and saddles should be in operation approximately 15 minutes prior to pump start up and remain in operation 15 minutes after pump shut down.

Typical applications include:

- Adhesive • Chocolate • Gelatine • Jam • Resin

Jackets are available on both the SRU and SX pump ranges, but saddles are only available on the SRU pump range.

8.2.6 Pump Overload Protection

Due to the positive action of the rotary lobe pump any restriction on the outlet side of the pump, either partial or total, will result in excessive pressure developing in the pumphead. It is therefore essential that some form of overload protection be installed to protect pump, drive unit and also limit pressure build up within associated process equipment. This protection will normally take the form of an external spring-loaded pressure relief valve fitted to the outlet side of the pump which will open under high pressure and allow fluid to return to the inlet side of the pump via a by-pass loop. Other alternatives are to fit the pump with an integral relief valve as described below, or use of proprietary electronic devices.

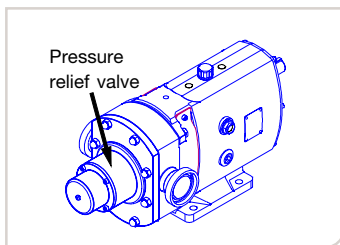

Fig. 8.2.6a Pressure relief valve

Pressure Relief Valves

These can be supplied as an integral part of the pump and do not require external pipework. The assembly replaces the standard rotorcase cover and is intended to protect the pump from over pressurisation. It is suitable for bi-direction pump operation and can be retrofitted. The valve will provide full pump protection for fluids having viscosities below 500 cP, above this figure Alfa Laval should be consulted with regard to specific flow rates in relation to viscosity and differential pressures. The design is such that the valve mechanism is isolated from the pumped fluid.

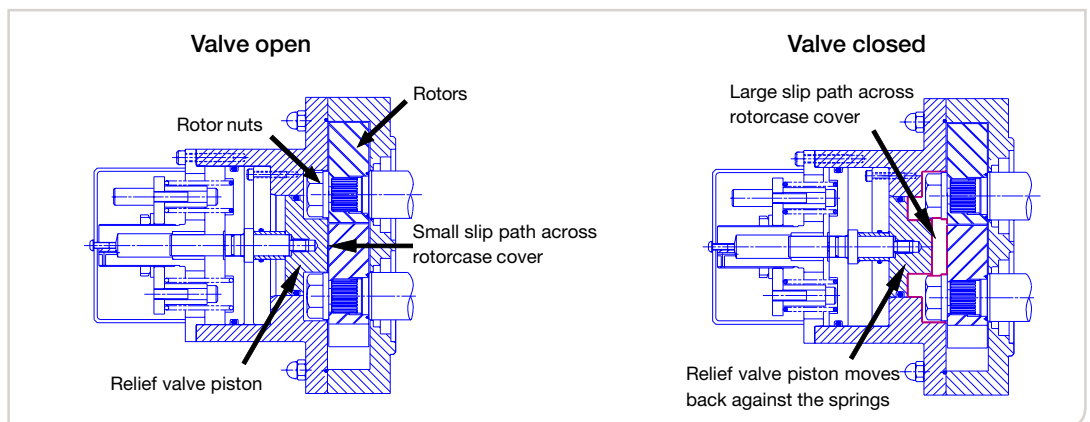

Fig. 8.2.6b Relief valve operation

As it is a mechanical device the relief valve does not operate instantaneously due to mechanical response time. The valve will begin to relieve at a pressure less than the fully open pressure. This ‘accumulation’ will vary depending upon the duty pressure, viscosity and pump speed. The accumulation tends to increase as pressure or pump speed decrease, and as viscosity increases. The valve is set to relieve at the required pressure by the correct choice of springs and can be adjusted on site to suit actual duty requirements.

The relief valve can be provided with the following options:

Automatic with Pneumatic Override

These valves may be pneumatically overridden for CIP conditions and they may be remotely controlled if required. Air supply should be clean and dry at pressures of 4 bar (60 psig) minimum and 8 bar (115 psig) maximum.

Automatic with Manual Override

This valve has a lever to enable manual override for CIP or certain tank filling applications.

Valve Type	Pump Range - Availability	Normal Operating Pressure Range	
		bar	psig
Standard	SRU1-6	7-19	100-275
Pneumatic override	SRU1-6	7-19	100-275
Manual override	SRU1-3	19	275
	SRU4-5	7-10	100-145
	SRU6	7	100

Table 8.2.6a

Pressure relief valves are only available for the SRU range pumps fitted with metal rotors.



Fig. 8.2.6c Pump protection unit

Pump Protection Unit (PPU)

The Pump Protection Unit is a non-intrusive alternative to mechanical relief valves, conventional electronic shear pin or mechanical over-load protection devices. It is designed to protect Alfa Laval rotary lobe pumps and incorporates micro-controller technology. The PPU is not a power meter or data-logging device but has the ability to monitor true consumption through continuous power monitoring. The PPU is not a pre-set device and requires a simple set-up procedure to be carried out to suit specific duty conditions of the pump to be monitored. After initial setting is completed the monitoring process is automatic and the pump is under the protection of the PPU.

The PPU will detect over-load and rapidly increasing load. One example of an over-load condition could result from a gradual increase in viscosity of the pumped media. This condition would in turn result in a higher discharge pressure, therefore increased power consumption. Another example could result from a partially closed valve in the discharge pipe also giving rise to excess pressure and therefore power consumption. As well as responding to system related transients, the PPU will also respond to mechanical changes such as bearing or lubrication failure, both of which could result in pump seizure if not detected and corrected.

The PPU will detect a rapidly increasing load such as that caused by a solid object entering the pump and becoming trapped between the rotors. The resulting rapid power increase from this type of event, even within the lines of the over-load trip threshold, will cause an automatic shutdown if desired thereby limiting the degree of damage.

The PPU will detect under-load since this highlights a condition preventing optimum pump operating efficiency. One example of under-load could result from a blocked or closed valve in the inlet pipe, a burst inlet or outlet pipe, or even an empty supply vessel.

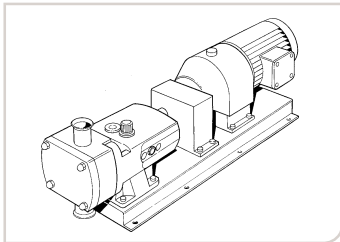

Fig. 8.2.7a Typical motorised rotary lobe pump unit

8.2.7 Ancillaries

Rotary Lobe pumps can be supplied bare shaft (without drive) or mounted on a baseplate with drive such as electric motor, air motor, and diesel or petrol engine dependent upon customer requirements and services available. Electric motors being the most commonly used method of drive, are described in more detail in section 9.

Fixed Speed

Rotary Lobe pumps generally operate at low to medium speeds i.e. 25 to 650 rev/min, and therefore some form of speed reduction is required from normal AC motor synchronous speeds of 1500, 1000 and 750 rev/min for 50 Hz (1800, 1200 and 900 rev/min for 60 Hz). This is generally achieved by using a geared electric motor direct coupled to the pump drive shaft via flexible coupling. An alternative arrangement would be an electric motor with a wedge belt pulley drive reducing the motor speed to the pump output speed required.

When exact flow is not critical a fixed speed drive is generally used. The integral geared electric motor is the most commonly used type of fixed speed drive. This is a compact low cost unit, which is easy to install, as it only requires one coupling and a safety guard.

Complete ranges of drive speeds are available from the different manufacturers and usually one can be found within a few rev/min of the required speed.

Some pumps operate continuously for 24 hours per day and others operate intermittently. How a pump operates will determine the choice of geared electric motor. Motor manufacturers give recommendations for their motors relating to the number of hours per day of operation and the frequency of starting and stopping.

Variable Speed

To handle changing duty conditions or a number of different duties, it may be necessary to use a variable speed drive or frequency converter to obtain correct pump duty speeds. There are many types of mechanical and hydraulic variable speed drives available in a wide range of speeds, which are well suited to rotary lobe pump characteristics by offering the ability to adjust the pump speed to control flow and adjust for system conditions. The frequency converter allows the operator to change the frequency of the electric motor, thereby changing pump speed and controlling flow (see 9.10).

Other Drive Types

Air motors, although not commonly used as pump drives, can provide good low cost drive in certain applications. In addition diesel or petrol engines can be used as pump drivers.

Baseplates

The Alfa Laval 'standard' is a pressed mild steel or stainless steel design which is required to be bolted to the floor (see 12.3). The Alfa Laval mild steel baseplate is supplied painted to suit customer requirements and the stainless steel has a dull polish finish. An alternative is to mount the pump and drive unit on a portable trolley design baseplate complete with control gear and trailing lead as required.

In some application areas such as dairy or brewing it is normal practice to hose down pump units and floorings – in these circumstances ball feet can be fitted to baseplates, which can be a fixed or variable height, to raise baseplate above floor level. Baseplates can also be designed to meet specific customer standards when required.

Guards

All rotating machinery should be adequately guarded and when pumps are supplied complete with a drive, a guard is fitted over the transmission (flexible coupling or wedge belt) which links the pump drive shaft to the output shaft of the selected driver.

The selection of guard material is important relative to its working environment. Non-sparking materials such as aluminium or brass are used with flameproof/explosion proof motors in hazardous areas. For non-hazardous applications mild steel or stainless steel is generally used.

9. Motors

This section describes electric motors, including information on motor protection, methods of starting, motors for hazardous environments and speed control.

The electric motor is the most commonly used method of pump drive, due to the following:

- Electrical power supply is usually readily available and easy to install.
- High efficiency due to low losses when transforming from electrical to mechanical power.
- The electric motor can absorb variations in the torque requirement of a pump, i.e. as a result of changes in product/duty conditions, inertia in the bearings, frequent starts etc.
- Easy speed control.

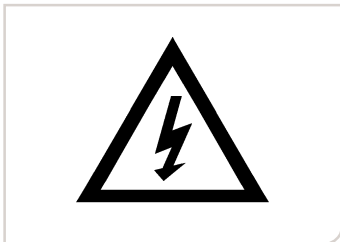

Fig. 9a Electrical hazard

All Alfa Laval pump ranges can be fitted with AC type Totally Enclosed Fan Ventilated (TEFV) squirrel cage three phase electric motors complying with various international standards and regulations such as IEC, CENELEC, VDE, DIN and BS. Electric motors supplied in the USA are generally to NEMA standard. Single phase electric motors can also be fitted to Alfa Laval rotary lobe pumps.

The standard design of an AC motor includes the following main parts:

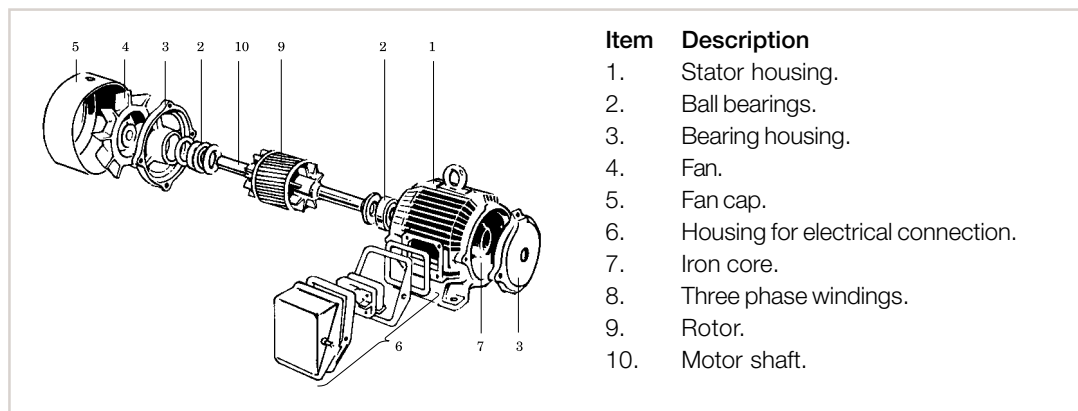

Fig. 9b Exploded view of a typical AC motor

The motor is constructed as follows:

- The stator is fixed in the stator housing (1).
- The ball bearings (2) are fixed in the bearing housing (3), which close the stator housing.
- The ball bearings carry the rotor (9) and the motor shaft (10).
- The fan (4), which cools the motor, is fixed to the motor shaft.
- The fan is protected by means of the fan cap (5).
- The housing for electrical connection (6) is situated on the stator housing.
- There is an iron core (7) in the stator housing. The iron core consists of thin iron sheets with a thickness of 0.3 - 0.5 mm.
- The three phase windings (8) are situated in the grooves of the iron core.

The three phase windings and the stator core are designed to produce a magnetic field in pairs of poles. When the stator is connected to a three-phase supply voltage the magnetic fields of the individual phase windings form a symmetrically rotating magnetic field which is called the rotational field. The speed of the rotational field is called the synchronous speed.

9.1 Output Power

The output power is always lower than the rated electrical power due to various losses in the motor. The ratio of output power to rated electrical power is known as the motor efficiency. The table below shows output power that is specified in standard ratings.

Frequency	Output Power in kW									
50 Hz	0.37	0.55	0.75	1.1	1.5	2.2	3	4	5.5	7.5
60 Hz	0.43	0.63	0.86	1.27	1.75	2.5	3.5	4.6	6.3	8.6
50 Hz	11	15	18.5	22	30	37	45	55	75	90
60 Hz	12.7	17.5	21	25	35	42	52	64	87	105

Table 9.1a

Frequency	Output Power in hp									
60 Hz	0.5	0.75	1	1.5	2	3	5	7.5	10	
	15	20	25	30	40	50	60	75	100	

Table 9.1b (Nema motors)

9.2 Rated Speed

The rated speed of the motor is always lower than the synchronous speed due to motor slip.

The connection between synchronous speed, rated speed, frequency and poles is shown in the table below:

No. Poles	2	4	6	8	12
No. Pairs of poles	1	2	3	4	6
Synchronous speed at 50 Hz - rev/min	3000	1500	1000	750	500
Rated speed at 50 Hz - rev/min	2880	1440	960	720	480
Synchronous speed at 60 Hz - rev/min	3600	1800	1200	900	720
Rated speed at 60 Hz - rev/min	3460	1720	1150	860	690

Table 9.2a

9.3 Voltage

Standard motors for use on 3 phase 50 or 60 Hz can be wound for any single voltage as follows:

Up to 3 kW (4 hp)	-	230 to 400 volts.
4 kW (5.5 hp) and over	-	400 to 690 volts.

Euronorm motors supplied at 400 volts will generally operate satisfactorily with voltage variations of $\pm 10\%$ from the rated voltage.

9.4 Cooling

Motor cooling is specified by means of the letters IC (International Cooling) in accordance with standards. The most common is IC411 (Totally Enclosed Fan Ventilated - TEFV) where an externally mounted fan cools the motor.

Methods of cooling are shown below:

Code	Arrangement
IC411	Totally Enclosed Fan Ventilated (TEFV) – motor cooled by an externally mounted fan
IC410	Totally Enclosed Non Ventilated (TENV) – self cooling, no externally mounted fan
IC418	Totally Enclosed Air Over Motor (TEAOM) – motor cooled by airstream
IC416	Totally Enclosed Forced Cooled (TEFC) – motor cooled by an independent fan

Table 9.4a

9.5 Insulation and Thermal Rating

Standard motors will operate satisfactorily in an ambient temperature range of -20°C (-68°F) to $+40^{\circ}\text{C}$ (104°F) (class B temperature rise) and at altitudes up to 1000 metres above sea level.

Motors supplied with class F insulation system with only class B temperature rise (80°C) (176°F) ensure an exceptional margin of safety and longer life even in abnormal operating conditions such as withstanding ambient temperatures up to 55°C (131°F) or 10% overload or adverse supply systems. Motors operating in ambient temperatures higher than 55°C (131°F) will have class H insulation. Some derating of the motor may be necessary for high ambient temperatures and high altitude.

9.6 Protection

The degree of motor protection is specified by means of the letters IP (International Protection) in accordance with standards. These state the method of determining degrees of ingress protection for both dust and water. The letters IP are followed by two digits, the first of which specifies the protection against contact and ingress of foreign bodies and the second digit specifies the protection against water. Table showing degrees of protection is shown below:

Designation	1 st Digit	2 nd Digit
	Protection against contact and ingress of foreign bodies	Protection against water
IP44	Protection against contact with live or moving parts by tools, wires or other objects of thickness greater than 1 mm. Protection against the ingress of solid foreign bodies with a diameter greater than 1 mm.	Water splashed against the motor from any direction shall have no harmful effect.
IP54	Complete protection against contact with live or moving parts inside the enclosure.	Water splashed against the motor from any direction shall have no harmful effect.
IP55	Protection against harmful deposits of dust. The ingress of dust is not totally prevented, but dust cannot enter in an amount sufficient to interfere with satisfactory operation of the machine.	Water projected by a nozzle against the motor from any direction shall have no harmful effect.
IP56		Motor protected against conditions on a ship's deck or powerful water jets.
IP65	No ingress of dust.	Water projected by a nozzle against the motor from any direction shall have no harmful effect.

Table 9.6a

Tropic Proof Treatment

Motors operating in tropical climates are invariably subjected to hot, humid and wet conditions, which will produce considerable amounts of condensation on internal surfaces. Condensation occurs when the surface temperature of the motor is lower than the dew-point temperature of the ambient air. To overcome this motors can be supplied with special tropic proof treatment. Failure to include this treatment and the resulting corrosion can cause irreparable damage to stator windings and moving parts.

Anti-Condensation Heaters

Where the motor is to be left standing for long periods of time in damp conditions it is recommended that anti-condensation heaters are fitted and energised to prevent condensation forming in the motor enclosure. These heaters are normally 110 volts or 220 volts.

Thermistors

To protect the motor windings from overload due to high temperature, motors can be fitted with thermistors, which are temperature-dependent semi-conductor devices embedded in the motor windings. Where motors can be allowed to operate at slow speed, i.e. being used with a frequency converter (see 9.9), it is normal to fit thermistors to prevent the motor from overloading or to insufficient cooling from the motor fan.

9.7 Methods of Starting

There are three starting methods:

1. Direct On Line (D.O.L.).
2. Star/Delta (Y/ Δ).
3. Soft.

Direct On Line Starting

The connection between supply voltage and rated current is very important with regards to motor starting. The simplest way to start the motor is to connect directly the mains supply to the motor. In this case the starting current is high, often 5 to 8 times higher than the rated current.

Motors fitted to centrifugal and liquid ring pumps are normally directly started, as the moment of inertia of the motor is low due to pump design and the fluids being pumped having low viscosities. In this case the starting time with high starting current is very low and it can consequently be ignored.

Star/Delta (Y/ Δ) Starting

If pumping viscous fluids the starting time with the high starting current is longer. It can, therefore, be necessary to restrict the starting current by means of Y/ Δ - starting of the motor. The current can be restricted by starting the motor in Y-connection and then changing to Δ -connection.

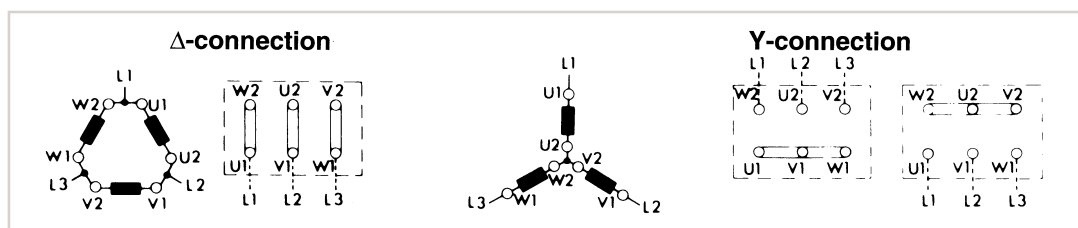

Fig. 9.7a Connection of three-phase single speed motor

Soft Starting

The soft start provides a smooth start at the same time, as the starting current is limited. The magnitude of the starting current is directly dependent on the static torque requirement during a start and on the mass of the load that is to be accelerated. In many cases the soft starter saves energy by automatically adapting the motor voltage continually to the actual requirement. This is particularly important when the motor runs with a light load.

Soft starting can also be achieved using a frequency converter.

9.8 Motors for Hazardous Environments

Zones

The degree of hazard varies from extreme to rare. Hazardous areas are classified into three Zones as follows:

By implication, an area that is not classified Zone 0, 1 or 2 is deemed to be a non-hazardous or safe area.

Zone 0,

in which an explosive gas-air mixture is continuously present or present for long periods – No motors may be used in this zone.

Zone 1,

in which an explosive gas-air mixture is likely to occur in normal operation.

Zone 2,

in which an explosive gas-air mixture is not likely to occur in normal operation and if it occurs it will only be present for a short time.

To ensure equipment can be safely used in hazardous areas, its gas group must be known and its temperature class must be compared with the spontaneous ignition temperature of the gas mixtures concerned.

Table 9.8a

Temperature class	Ignition temperature for gas/vapour	Max. permitted temperature of electrical equipment
T1	up to 450°C (842°F)	450°C (842°F)
T2	300 to 450°C (572 to 842°F)	300°C (572°F)
T3	200 to 300°C (410 to 572°F)	200°C (410°F)
T4	135 to 200°C (275 to 410°F)	135°C (275°F)
T5	100 to 135°C (212 to 275°F)	100°C (212°F)
T6	85 to 100°C (185 to 212°F)	85°C (185°F)

Group I	Equipment for coal mines susceptible to methane gas.
Group II	Equipment for explosive atmospheres other than mines i.e. surface industries.
IIA IIB IIC	Group II is subdivided according to the severity of the environment. IIC is the highest rating. A motor from one of the higher categories can also be used in a lower category.

Table 9.8b

Flameproof Enclosure - EEx d and EEx de

These motors are designated for operation in Zone 1 hazardous areas. The motor enclosure is designed in such a way that no internal explosion can be transmitted to the explosive atmosphere surrounding the machine. The enclosure will withstand, without damage, any pressure levels caused by an internal explosion.

The temperature of the motor's external enclosure should not exceed the self-ignition temperature of the explosive atmosphere of the installation area during operation. No motor device outside the flameproof area shall be a potential source of sparks, arcs or dangerous overheating.

Variants combining two types of protection usually combine 'd' and 'e' types of protection. The most commonly used and recognised by the CENELEC European Standards is the EEx de variant. The motor is designed with an EEx d flameproof enclosure, while the terminal box features an EEx e increased safety protection. Such design combines the superior safety degree of the 'd' type of protection with the less stringent electrical connection requirements of increased safety motors.

Increased Safety Design - EEx e

The design of this motor type prevents the occurrence of sparks, arcs or hot spots in service, that could reach the self-ignition temperature of the surrounding, potentially explosive atmosphere, in all inner and outer parts of the machine.

Non-Sparking Design – EEx nA, Ex nA, Ex N

These motors are designated for operation in Zone 2 hazardous areas. The motor construction is similar to standard TEFV motors, but with special attention to eliminate production of sparks, arcs or dangerous surface temperatures.

The British Standard is the type Ex N version. The marking according to standard EN 50021 is EEx nA, where EEx n = European standard for Ex product with protection 'n', A = for non-sparking equipment.

The classification parameters of motors for hazardous areas can be summarised as below:

Fig. 9.8a Overview of classification parameters

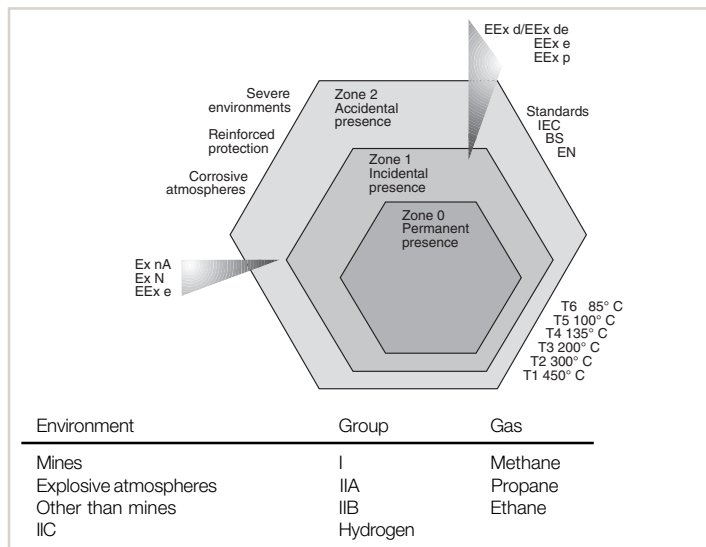

9.9 Energy Efficient Motors

In October 1998, the European Union and CEMEP (The European Committee of Manufacturers of Electrical Machines and Power Electronics) agreed to introduce three efficiency classes for electric motors. This agreement forms part of the European Commission’s aims to improve energy efficiency and reduce CO₂ emissions. The burning of fossil fuels to generate electricity, primarily consumed by households and industry, is a major source of greenhouse gas emissions. Industry will, therefore, have a major part to play in reducing harmful emissions. For instance by increasing the efficiency of their production processes, and installing energy efficient devices, industrial processes will consume less electricity. This, in turn, will reduce the amount of electricity that must be generated to meet demand.

Motors account for around 65% of the electric energy consumed in industrial applications. Energy saving is dependent upon the kW rating of the motor, the loading and the hours run. As such, higher efficiency motors can play a significant part in reducing CO₂ emissions. An energy efficient motor produces the same output power (torque) but uses less electrical input power (kW) than a standard electric motor. This higher efficiency is achieved by using higher quality and thinner laminations in the stator to reduce core loss and more copper in the slots to reduce current and resistance losses.

The three efficiency classes designated EFF1, EFF2 and EFF3, apply to TEFC, 2 and 4 pole, squirrel cage induction motors in the power range 1.1 to 90 kW (*1.5 to 125 hp*) rated for 400 volts, 50 Hz.

For intermittent usage, EFF3 class motors can be used and for continuous usage EFF1 or EFF2 motors should be used.

Table 9.9a

Output Power		2 pole Motor		
kW	hp	EFF1 equal to or above	Efficiency % EFF2 equal to or above	EFF3 below
1.1	1.5	82.8	76.2	76.2
1.5	2	84.1	78.5	78.5
2.2	3	85.6	81.0	81.0
3	4	86.7	82.6	82.6
4	5.5	87.6	84.2	84.2
5.5	7.5	88.6	85.7	85.7
7.5	10	89.5	87.0	87.0
11	15	90.5	88.4	88.4
15	20	91.3	89.4	89.4
18.5	25	91.8	90.0	90.0
22	30	92.2	90.5	90.5
30	40	92.9	91.4	91.4
37	50	93.3	92.0	92.0
45	60	93.7	92.5	92.5
55	75	94.0	93.0	93.0
75	100	94.6	93.6	93.6
90	125	95.0	93.9	93.9

Table 9.9b

Output Power		4 pole Motor		
kW	hp	EFF1 equal to or above	Efficiency % EFF2 equal to or above	EFF3 below
1.1	1.5	83.8	76.2	76.2
1.5	2	85.0	78.5	78.5
2.2	3	86.4	81.0	81.0
3	4	87.4	82.6	82.6
4	5.5	88.3	84.2	84.2
5.5	7.5	89.2	85.7	85.7
7.5	10	90.1	87.0	87.0
11	15	91.0	88.4	88.4
15	20	91.8	89.4	89.4
18.5	25	92.2	90.0	90.0
22	30	92.6	90.5	90.5
30	40	93.2	91.4	91.4
37	50	93.6	92.0	92.0
45	60	93.9	92.5	92.5
55	75	94.2	93.0	93.0
75	100	94.7	93.6	93.6
90	125	95.0	93.9	93.9

9.10 Speed Control

The effective speed control of AC electric motors has long been regarded as an adaptable and economical means of reducing costs and saving energy.

Speed control can be multi-speed, variable voltage or frequency converter.

Multi-Speed

Pole Change (Tapped or Dahlander)

These have a single winding and two speeds in a ratio of 2:1 and can be supplied for constant torque or variable torque applications.

PAM (Pole Amplitude Modulation)

Similar to above except that pole variations can be 4/6 or 6/8.

Dual Wound

Motors have two separate windings and can be supplied for any two speed combinations.

A combination of dual and pole change windings can give 3 or 4 speeds from one design.

Variable Voltage

Variable voltage control provides a low capital cost means of varying the motor speed on centrifugal pumps. This form of speed control requires greater derating than for converter drives and is best suited to 4 pole machines of 2:1 speed reduction with close matching of motor output to absorbed pump load. These motors are of special design – standard motors being unsuitable.

Frequency Converter

The use of a frequency converter will allow speed control of a standard AC motor by adjusting the frequency, although some derating may be necessary. Basic frequency converters will permit operation over a typical speed range of 20:1. With increasing sophistication such as 'vector' control, e.g. field oriented control utilising closed loop feedback; the effective speed range can be increased to 1000:1.

For applications using variable torque loads such as centrifugal pumps, very little derating will be required. For applications using constant torque loads such as rotary lobe pumps, the level of derating will depend on the speed range required.

The motor ratings must take into account the following:

- Increased heating due to the harmonic content of the inverter waveforms.
- Reduced cooling arising from motor speed reduction.
- The power or torque requirements throughout the entire speed range.
- Other limiting factors such as maximum motor speeds, ambient temperature, altitude etc.

As well as motors being remotely controlled by frequency converters, electric motors can be made available with the frequency converter already fitted to the motor. These arrangements are generally available for motors up to 7.5 kW (10 hp) and have the advantage of not using any shielded motor cables, as there are no extra connections between the frequency converter and motor. Also providing room in a switch cabinet will not be necessary.

9.11 Changing Motor Nameplates - Centrifugal and Liquid Ring Pumps only

In some instances there are non-standard electrical requirements regarding combinations of supply voltage, frequency and output power. When selecting a motor for a centrifugal or liquid ring pump, special attention should be given to the rated speed and output power.

As viewed from table below which shows an example for a motor frame size 90LB, the rated speed and output power will vary dependent upon the combination of supply voltage and frequency. For complete list see section 14.8. It is therefore very important to specify supply voltage, frequency and required power, to correctly size the motor.

Motor Frame Size	Frequency Hz	Supply Voltage v	Output Power kW	Motor Nameplate	Rated Speed rev/min	Power Factor	Rated Current A
90LB	50	220-240Δ/380-420Y	2.2	Standard	2900	0.85	8.1/4.7
		200Δ	2.2	New	2860	0.90	8.7
90LB	60	440-480Y	2.5	Standard	3500	0.86	4.4
		200Δ	2.1	New	3430	0.91	8.3
		220Δ	2.3	New	3470	0.90	7.5
		380Y	2.3	New	3450	0.91	4.8

Table 9.11a

Standard supply voltage, frequency and output power

The motors can be used in the standard version without any modifications for the standard supply voltage, frequency and output power combinations. This is shown in section 9.1. For example, if using a motor frame size 90LB, from the table above, the motor can be used as standard as follows:

50 Hz, 220-240vΔ/380-420vY, 2.2 kW

60 Hz, 440-480vY, 2.5 kW

Non-standard supply voltage, frequency and output power

If a non-standard combination of supply voltage, frequency and output power is required, the standard motor with a new nameplate or a special motor with an appropriately stamped nameplate can be used. Examples of this are as follows using a motor frame size 90LB from the table above.

Example 1**- For 60 Hz, 380vY, 2.2 kW**

1. Use a standard motor frame size 90LB.
2. The appropriate electrical data must be changed on the motor nameplate.
3. The motor will give an output power of 2.3 kW, which is sufficient, as 2.2 kW is required.

Example 2**- For 60 Hz, 380vY, 2.5 kW**

1. The standard motor frame size 90LB will only give 2.3 kW, which is not sufficient.
2. Select the nearest larger standard motor i.e. frame size 100LB. This will give 3.2 kW, which is sufficient, as 2.5 kW is required. The appropriate electrical data must be changed on the motor nameplate.
3. Alternatively select a specially wound motor to give the required 2.5 kW at the non-standard supply voltage and frequency combination.

10. Cleaning Guidelines for use in Processes utilising CIP (Clean In Place) Systems

This section provides cleaning guidelines for use in processes utilising CIP (Clean In Place) systems. Interpretations of cleanliness are given and explanations of the cleaning cycle.

The following recommendations offer advice on how to maximise the CIP (Clean In Place) efficiency of the Alfa Laval ranges of centrifugal and rotary lobe pumps. The guidelines incorporate references to internationally recognised cleaning detergents, velocities, temperatures and pressures used to clean other types of flow equipment, such as valves and fittings, but have been specifically prepared to maximise the CIP effectiveness of our pumps.

The perception of the word clean will vary from customer to customer and process to process. The four most common interpretations of 'Clean' are given below:

1. Physical Cleanliness

This is the removal of all visible dirt or contamination from a surface. This level of cleanliness is usually verified by a visual test only.

2. Chemical Cleanliness

This is defined as the removal of all visible dirt or contamination as well as microscopic residues, which are detectable by either taste or smell but not by the naked eye.

3. Bacteriological Cleanliness

This can only be achieved with the use of a disinfectant that will kill all pathogenic bacteria and the majority of other bacteria.

4. Sterility

Quite simply this is the destruction of all known micro-organisms.

The following recommendations for CIP will address the first three definitions.

In most installations it is important to ensure the maximum recovery of pumped product residues from the production line at the end of each production run. Where this is a requirement, consideration should be given to mounting rotary lobe pumps with ports in the vertical plane to maximise drainability. This will minimise any product loss, ease the cleaning of the system and reduce the requirement to dispose of or recycle the wash from the initial cleaning cycles. By maximising the recovery of product from the system both the efficiency of the production and cleaning processes will be increased.

Rotary lobe pumps are rarely used as the supply pump for CIP fluids. Centrifugal pumps are generally used during CIP for each phase of the cleaning cycle. For the majority of CIP cycles it is recommended that a differential pressure of 2 to 3 bar is created across the pump to promote efficient cleaning, whilst it is rotating at its normal operating speed. In many cases a valve is employed in the discharge line of the system to create the differential pressure across the pump and a by-pass loop installed around the pump to divert any excess of CIP liquid that the pump is unable to transfer. The valve(s) setting may be fluctuated during the CIP cycle to promote pressure/flow variations that may enhance the cleaning process.

During the CIP cycle there must always be sufficient flow of cleaning fluid being delivered by the CIP pump to make sure that the centrifugal or rotary lobe pump is neither starved of liquid at its inlet due to its own flow capability, or overpressurised at its inlet due to its tendency to act as a restriction if it is unable to transfer the full flow of the fluid being delivered to it.

Internationally accepted protocol for CIP suggest that during all phases of the CIP cycle a pipeline velocity of between 1.5 m/sec and 3.0 m/sec is required. Velocities within this range have proven to provide effective cleaning of Alfa Laval pumps, although as a general rule the higher the velocity the greater the cleaning effect.

Generally the most effective cleaning processes incorporate five stages:

1. An initial rinse of clean, cold water.
2. Rinsing with an alkaline detergent.
3. Intermediate rinse with cold water.
4. Rinsing with an acidic disinfectant.
5. Final rinse with clean cold water.

The cycle times, temperatures, cleaning mediums and concentrations of the detergents used will all influence the effectiveness of the cleaning cycle and care must be taken when defining these to ensure that they are suitable for use with the particular product being pumped. Of equal importance is the chemical compatibility between the cleaning detergents and the product wetted materials in the pump head and ensuring for rotary lobe pumps the correct temperature clearance rotors are fitted for the CIP cycle. Consideration should also be given to the disposal or recycling of used cleaning liquids and the potential requirement for handling concentrated detergents. Specialists suppliers should make the final selection of cleaning detergents/disinfectants.

Within these guidelines a typical cleaning cycle would be as follows:

1. Rinse with clean water at ambient temperature to remove any remaining residue. 10 to 15 minutes are usually sufficient for this part of the cycle but this will depend on the condition and volume of the residue to be removed.
2. Rinse with an alkaline detergent, typically a 2.5% solution of Caustic Soda (NaOH) at between 70 to 95°C (158 to 203°F) for a period of 20 to 30 minutes would be used. It is also common to add a wetting agent (surfactant) to lower the surface tension of the detergent and hence aid its cleansing ability. This phase of the cleaning cycle should dissolve and remove organic matter such as fats and proteins.
3. Intermediate rinse with clean water at ambient temperature for a period of 5 to 10 minutes. This phase should remove any residual detergents.
4. Rinse with an acidic disinfectant, typically a 2.5% solution of Nitric Acid (HNO₃) at ambient temperature for a period of 10 to 15 minutes would be used. This phase of the cleaning cycle should remove proteins, mineral salts, lime and other deposits.
5. Final rinse with clean water at ambient temperature for a period of 10 to 15 minutes or until all traces of the cleaning fluid have been removed.

During the CIP cycles it is important that the required concentration of cleaning detergents is maintained consistently. A significant increase in concentration could cause damage to pumps and other components in the system. A significant decrease in concentration could effect the detergents cleaning efficiency. A facility for monitoring and adjusting the detergent concentration should be considered.

Cautionary Notes:

1. Pumps and other equipment installed in CIP systems have components within them that will expand and contract at different rates. Care should be taken not to subject them to rapid temperature cycling.
2. Products containing particulate such as fibre, seeds or soft fleshy matter have to be evaluated carefully and on an individual basis, as the nature of these will provide an increased cleaning challenge. These types of product may typically require increased cleaning cycle times and/or increased velocities and pressures during the cleaning cycle.
3. CIP detergent liquids and the elevated temperatures typically used for CIP processes can cause a potential health risk. Always adhere to site Health and Safety regulations.
4. Always store and dispose of cleaning agents in accordance with site Health and Safety regulations.

After CIP cleaning and additional sterilisation in place process (SIP) may be required when highly sensitive products are handled, inactivating any micro-organisms which might be still present in the pump. The sterilisation can be carried out by means of chemicals, hot water or steam. In the dairy industry the sterilisation temperature is approximately 145°C (293°F).

11. Compliance with International Standards and Guidelines

This section describes some of the international standards and guidelines applicable to Alfa Laval pump ranges.

In recent years there has been increasing concern over safety and hygiene in the bio-pharmaceutical and food industries. This has led to numerous standards and legislation being written.

A number of countries have national standards and/or directives applicable to food machinery but there are relatively few international standards. Those that exist are predominantly dairy based and are too general and developed on 'experience' rather than scientific data. In the USA, a number of guidelines in the form of third party approval schemes have been developed for the dairy industry (3-A standards) and food service equipment (NSF – National Sanitation Foundation). The structure of these schemes involves representatives of equipment manufacturers, end users and regulatory bodies in the implementation of recommendations. Unfortunately, however the 3-A standards have no benchmark of cleanability or test regimes to establish cleanability, and the NSF standards are not applicable to the hygienic design of general food processing equipment.

Alfa Laval pump ranges are available to meet standards and legislation as follows:

- CE Compliance (Safety/Risk Assessment).
- 3-A Design and Material Specifications (Centrifugal and Positive Rotary Lobe Pumps for Milk and Milk Products).
- FDA Material Requirements.
- USDA Regulating Biotechnology.
- EN 10204 3.1.B Certified Material Traceability.
- EN 10204 2.2 Certificate of Conformity.
- EHEDG Cleanability and Installation Guidelines.

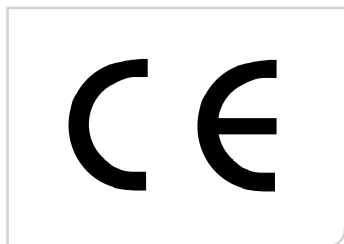

Fig. 11a CE

CE

The introduction of CE marking is to demonstrate to interested parties that goods or equipment with this mark comply with the appropriate directives of the European Community. The appropriate directives are those that are concerned with the design and manufacture of goods or equipment. Directives are intended to facilitate a Single Market in the European Union. With emerging European standardisation, conflicting national standards will eventually tend to disappear, as all EU member states will work to the same standard, with a few exceptions. Some national differences cannot be harmonised. In Europe many different languages are spoken, and some parts are prone to earthquakes, high winds, heavy snow and extremes of cold and heat. It is often uneconomic to design equipment that will withstand all these conditions.

All Alfa Laval pump ranges are CE marked and conform to the machinery directive 89/392/EEC as amended by 91/368/EEC, 93/44/EEC and 93/68/EEC and other relevant directives i.e. 'Electrical Equipment Low Voltage Directive 73/23/EEC' and 'Electromagnetic Compatibility Directive 89/336/EEC'.

Other applicable standards/specifications which Alfa Laval pump ranges comply to are as follows:

- EN292 Parts 1 and 2: 1991 Safety of Machinery - Basic concepts, general principles for design.
- EN294: 1992 Safety distances to prevent danger zones being reached by the upper limbs.
- EN60204 Part 1: 1993 Safety of Machinery - Electrical equipment of machines - specification for general requirements.
- BS5304: 1988 Code of Practice for Safety of Machinery.
- ISO9001: 1994 Quality Management System.



Fig. 11b 3-A

3-A (Centrifugal and Positive Rotary Pumps for Milk and Milk Products)

This standard has the purpose of establishing and documenting the material, fabrication, and installation (where appropriate) requirements for the engineering design and technical construction files for all products, assemblies, and sub-assemblies supplied by the manufacturer. The manufacturer has to be in compliance with the sanitary criteria found in 3-A Sanitary Standards or 3-A Accepted Practices. The 3-A Sanitary Standards and 3-A Accepted Practices are voluntarily applied as suitable sanitary criteria for dairy and food processing equipment.

All Alfa Laval pump ranges conform to this 3-A standard.

FDA

The Food and Drug Administration (FDA) in the USA is the enforcement agency of the United States Government for food, drug and cosmetics manufacturing. It is responsible for new material approvals, plant inspections and material recalls. In the USA, the 'Food, Drug and Cosmetic Act' requires food, drug and cosmetic manufacturers to prove that their products are safe. The FDA's primary purpose is to protect the public by enforcing this Act.

The FDA can:

- approve plants for manufacturing.
- inspect plants at random.
- write general guidelines for good manufacturing processes.
- write specific criteria for materials in product contact.
- have certain expectations regarding design practices.

The FDA cannot:

- approve equipment outside of a particular use within a specific system.
- approve materials for use in pharmaceutical systems.
- write specific engineering or design requirements for systems.

For all Alfa Laval pump ranges the product wetted parts can be made available with FDA compliance.

All Alfa Laval pump ranges can be supplied into process areas/plants that are controlled by USDA.

USDA

The United States Department of Agriculture (USDA) is one of three Federal Agencies, along with the Environmental Protection Agency (EPA) and the U.S. Food and Drug Administration (FDA), primarily responsible for regulating biotechnology in the United States. Products are regulated according to their intended use, with some products being regulated under more than one agency.

Agricultural biotechnology is a collection of scientific techniques, including genetic engineering, that are used to create, improve, or modify plants, animals, and micro-organisms. Using conventional techniques, such as selective breeding, scientists have been working to improve plants and animals for human benefit for hundreds of years. Modern techniques now enable scientists to move genes (and therefore desirable traits) in ways they could not before - and with greater ease and precision.

The Federal government has a well co-ordinated system to ensure that new agricultural biotechnology products are safe for the environment and to animal and human health. While these agencies act independently, they have a close working relationship.

- USDA's Animal and Plant Health Inspection Service (APHIS) is responsible for protecting American agriculture against pests and diseases. The agency regulates the field testing of genetically engineered plants and certain micro-organisms. APHIS also approves and licenses veterinary biological substances, including animal vaccines that may be the product of biotechnology.
- USDA's Food Safety and Inspection Service (FSIS) ensures the safety of meat and poultry consumed as food.
- The Department of Health and Human Service's Food and Drug Administration (FDA) governs the safety and labelling of drugs and the nation's food and feed supply, excluding meat and poultry.
- The Environmental Protection Agency (EPA) ensures the safety and safe use of pesticidal and herbicidal substances in the environment and for certain industrial uses of microbes in the environment.

- The Department of Health and Human Service's National Institutes of Health have developed guidelines for the laboratory use of genetically engineered organisms. While these guidelines are generally voluntary, they are mandatory for any research conducted under Federal grants and they are widely followed by academic and industrial scientists around the world.

The Alfa Laval Rotary Lobe pump ranges and the LKH-UltraPure range of Centrifugal pumps can be supplied with material traceability if required.

EN 10204 3.1.B

With the stringent demands of hygiene within new food and pharmaceutical plants being built, material traceability of equipment supplied is increasingly important. The EN 10204 standard defines the different types of inspection documents required for metallic products. In particular, 3.1.B of this standard refers to inspection documents being prepared at each stage of manufacture and supervised tests performed by authorised personnel independent of the manufacturer.

EN 10204 2.2

This standard defines documents supplied to the purchaser, in accordance with the order requirements, for the supply of metallic products such as pumps. This takes the form of a certificate of conformity and can be applied to all Alfa Laval pump ranges.

EHEDG

We are now seeing increased public awareness surrounding food hygiene and food manufacturers desire to improve product safety. With no European Community legislation available the European Hygienic Equipment Design Group (EHEDG) was formed. EHEDG aims to promote hygiene during the processing and packaging of food products.



Fig. 11c EHEDG

EHEDG objectives are to produce hygienic design guidelines that can be verified by standard test procedures. This requires a range of test procedures for a variety of equipment parameters including cleanability, pasteurisability, sterilisability and aseptic capability.

The Alfa Laval LKH range of centrifugal pumps and the SX range of rotary lobe pumps with its dedicated vertical port orientation meet EHEDG cleanability and comply with EHEDG installation guidelines.

12. Installation Guide

This section covers guidelines relating to pump installation, system design and pipework layout.

12.1 General

12.1.1 System Design

To ensure optimum pump operation it is important that any pump unit is installed correctly. When designing a pumping system the following should be taken into consideration:

- Confirm the Net Positive Suction Head (NPSH) available from the system exceeds the NPSH required by the pump, as this is crucial for ensuring the smooth operation of the pump and preventing cavitation.
- Avoid suction lifts and manifold/common suction lines for two rotary lobe pumps running in parallel, as this may cause vibration or cavitation (see fig. 12.1.1a).

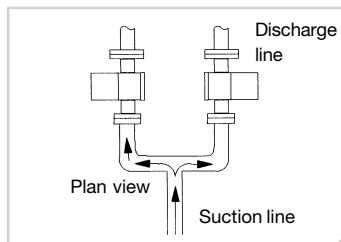

Fig. 12.1.1a Avoid common suction lines

- Protect the pump against blockage from hard solid objects e.g. nuts, bolts etc. Also protect the pump from accidental operation against a closed valve by using relief valves, pressure switches and current limiting devices.
- Fit suction and discharge pressure monitor points for diagnostic purposes.
- Fit valves, if two pumps are to be used on manifold/common discharge lines.

- Make the necessary piping arrangements if flushing is required for the seal or if a media is required for heating/cooling jackets.
- Adhere to installation foundation instructions.
- Do not subject rotary lobe pumps to rapid temperature changes, as pump seizure can result from thermal shock.

12.1.2 Pipework

All pipework must be supported. The pump must not be allowed to support any of the pipework weight and the following should be taken into consideration.

- Have short straight inlet pipework to reduce friction losses in the pipework thereby improving the NPSH available.
- Avoid bends, tees and any restrictions close to either suction or discharge side of pump. Use long radius bends wherever possible.
- Provide isolating valves on each side of the pump when necessary.
- Keep pipework horizontal where applicable to reduce air locks. Include eccentric reducers on suction lines.

12.1.3 Weight

The weight of the pump and drive unit should be considered for lifting gear requirements.

12.1.4 Electrical Supply

Ensure that there is an adequate electrical supply close to the pump drive unit. This should be compatible with the electric motor selected.

12.2 Flow Direction

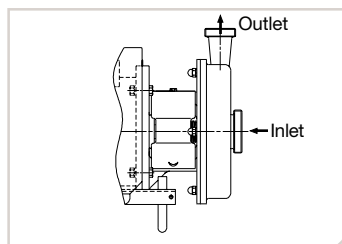

Fig. 12.2.1a Correct direction of flow

12.2.1 Centrifugal Pumps

A centrifugal pump should never be operated in the wrong direction of rotation with fluid in the pump. It is possible to check this in two ways as follows:

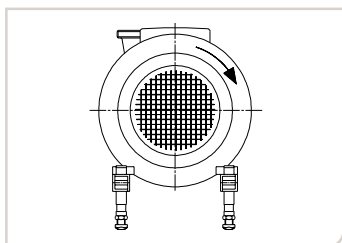

Fig. 12.2.1b Pump with impeller screw fitted

1. Pump with impeller screw fitted

- Start and stop the motor momentarily (without fluid in the pump).
- Ensure that the direction of rotation of the motor fan is **clock-wise** as viewed from the rear end of the motor.

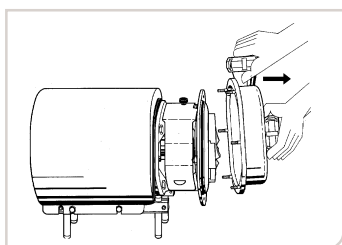

Fig. 12.2.1c Pump without impeller screw fitted

2. Pump without impeller screw fitted

With this method the impeller should always be removed before checking the direction of rotation.

The pump should never be started if the impeller is fitted and the pump casing has been removed.

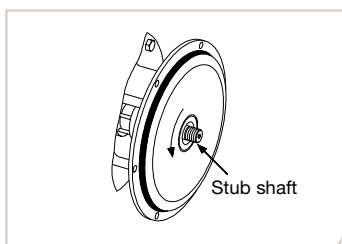

Fig. 12.2.1d Pump without impeller

- Start and stop the motor momentarily.
- Ensure that the direction of rotation of the stub shaft is **anti-clockwise** as viewed from the pump inlet.

12.2.2 Rotary Lobe Pumps

The direction of flow is dictated by the direction of drive shaft rotation. Reversing the direction of rotation will reverse the flow direction.

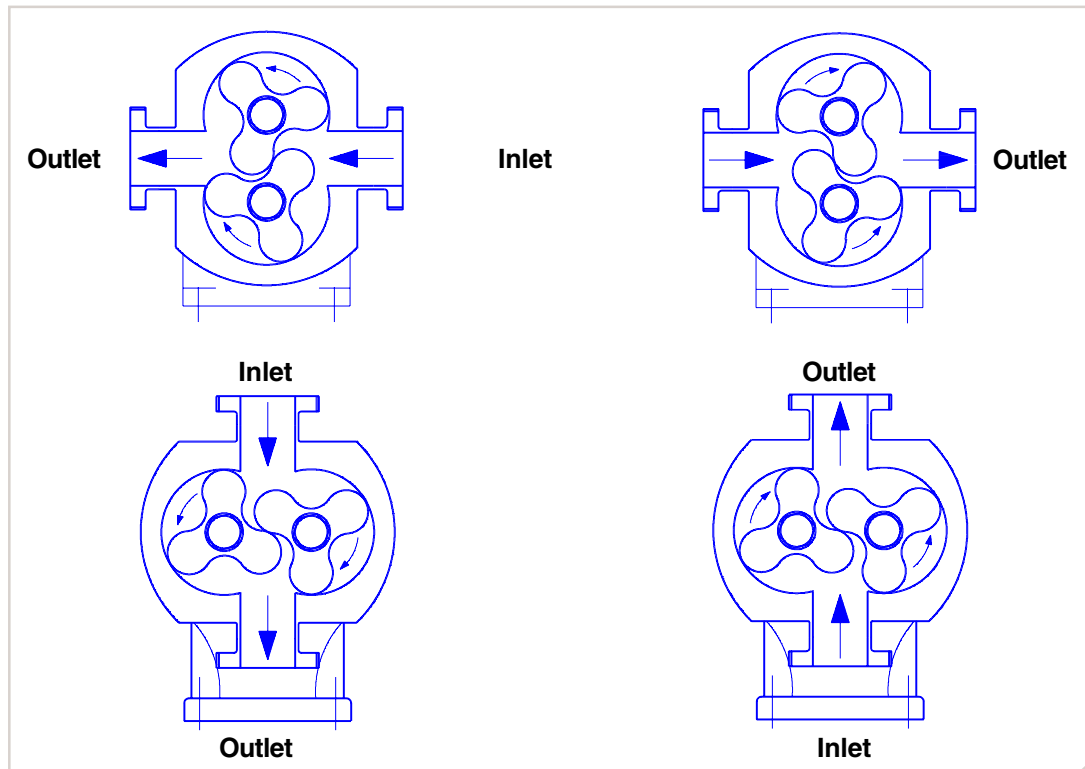

Fig. 12.2.2a Flow direction

12.3 Baseplate Foundations (Rotary Lobe Pumps only)

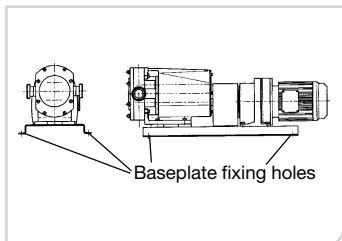

Fig. 12.3a Baseplate fixing

Rotary Lobe pumps when supplied with a drive unit are normally mounted on a baseplate. Alfa Laval standard baseplates have pre-drilled fixing holes to accept base retaining bolts.

To provide a permanent rigid support for securing the pump unit, a foundation is required which will also absorb vibration, strain or shock on the pumping unit.

Methods of anchoring the baseplate to the foundation are varied, they can be studs embedded in the concrete either at the pouring stage as shown below, or by use of epoxy type grouts. Alternatively mechanical fixings can be used.

The Foundation should be approximately 150mm longer and wider than the baseplate. The depth of the foundation should be proportional to the size of the complete pump unit. For example, a large pump unit foundation depth should be at least 20 times the diameter of the foundation bolts.

The drawing below shows two typical methods for foundation bolt retaining. The sleeve allows for 'slight' lateral movement of the bolts after the foundation is poured. Rag or waste paper can be used to prevent the concrete from entering the sleeve while the foundation is poured. A minimum of 14 days is normally required to allow the curing of the concrete prior to pump unit installation.

D = Diameter of foundation bolts

Fig. 12.3b Foundations

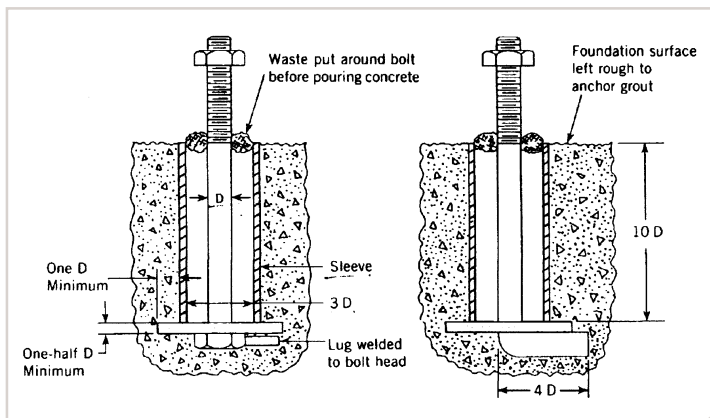

12.4 Coupling Alignment (Rotary Lobe Pumps only)

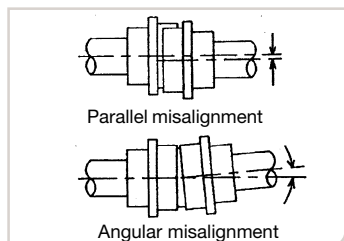

Fig. 12.4a Parallel and angular misalignment

Before rotary lobe pump units are installed it is important to ensure that the mounting surface is flat to avoid distortion of the baseplate. This will cause pump/motor shaft misalignment and pump/motor unit damage. Once the baseplate has been secured, the pump shaft to motor shaft coupling alignment should be checked and adjusted as necessary. This is achieved by checking the maximum angular and parallel allowable misalignments for the couplings as stated by the coupling manufacturers.

12.5 Special Considerations for Liquid Ring Pumps

12.5.1 Pipework

The pipelines on the discharge side of a liquid ring pump should be routed as shown below to ensure correct pump operation.

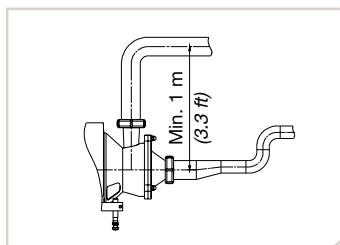

Fig. 12.5.1a Installation of MR-166S/-185S/-200S

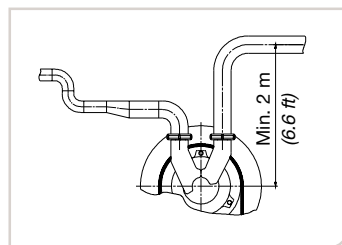

Fig. 12.5.1b Installation of MR-300

13. Troubleshooting

This section offers possible causes and solutions to most common problems found in pump installation and operation.

13.1 General

In most pumping systems, pumps are likely to be the most vulnerable components. The symptoms frequently show the pump to be at fault regardless of what may be wrong. The problem is usually caused by inadequate control of the pumped fluid or a change in operating requirements of which the system or pump is not capable of handling or a component malfunction.

Diagnosis of problems will be greatly assisted by having pressure gauges fitted to both pump inlet and outlet.

Before starting to correctly identify the problem it is important to gather as much information relating to the process as follows:

- Reconfirm original duty conditions.
- What has changed in the process since operation was last satisfactory? i.e. pressure, temperature, fluid viscosity etc.
- Was the system undergoing routine maintenance?
- Were any new or repaired components omitted to be fitted?
- When was the pump last serviced?
- What was the appearance and condition of the pump internal components?
- How long did the pump operate before the problem?
- Any changes in pump noise or vibration?

The most common problems found are generally as follows and explained in 13.2:

- Loss of flow.
- Loss of suction.
- Low discharge pressure.
- Excessive noise or vibration.
- Excessive power usage.
- Rapid pump wear.
- Seal leakage.

13.2 Common Problems

13.2.1 Loss of Flow

A simple cause of this could be incorrect direction of shaft rotation, which although obvious is often overlooked. Loss of flow can be caused by excessive discharge pressure and/or by a change in fluid viscosity.

In general terms:

- For a rotary lobe pump if the viscosity is significantly reduced, the pump's rated flow will be reduced, more so for higher pressure operation.
- For a centrifugal pump if the viscosity is increased, the pump's rated flow will be decreased.

13.2.2 Loss of Suction

Loss of suction can be minor, causing little short term damage or sufficiently major to cause catastrophic damage. Loss of suction means fluid is not reaching the pumping elements or not reaching them at a sufficiently high pressure to keep the fluid being pumped in a fluid state. Loss of suction can be interpreted as the inability to prime, cavitation or a gas content problem.

The rotary lobe pump can be classed as 'self-priming'. This means that within limits, it is capable of evacuating (pumping) a modest amount of air from the suction side of the pump to the discharge side of the pump. Filling the inlet system with fluid or at least filling the pump (wetted pumping elements) will make a major improvement in the pump's priming capability.

The liquid ring pump can also be classed as self-priming when the pump casing is half filled with fluid and the LKHSP centrifugal pump range is specially designed to be self-priming.

Cavitation is caused by insufficient system inlet pressure to the pump. This can be caused by an inlet system restriction, excessive fluid viscosity or excessive pump speed. Inlet restrictions can include dirty or clogged inlet strainers, debris floating in the fluid supply that covers the inlet piping intake, or rags. If the fluid is cooler than design temperature, its viscosity may be too high causing excessive friction (pressure loss) in the inlet piping system. Cavitation is frequently accompanied by noise, vibration and significant increase in discharge pressure pulsation. If a pump is allowed to cavitate over long periods this will cause damage to the pumphead components. The surface of these components are typically perforated and pitted.

Gas in the inlet pipework has the same impact on pump operation and creates the same symptoms as cavitation. This can occur under other circumstances such as a pump operating at an inlet pressure below local atmospheric pressure. In this instance it is quite likely that air is being drawn into the pipework through a loose pipe connection or pump casing joint, leaking inlet valve stem, defective or otherwise damaged joint gasket in the pipework system. In recirculating systems, such as a lubrication system where the fluid pumped is continuously returned to a supply source or tank, if the tank and return lines are not adequately designed, located and sized, air is easily entrained in the oil and immediately picked up by the pump inlet system. Be sure fluid level at its source is at or above minimum operating levels. Lines returning flow to a supply tank should terminate below minimum fluid level.

13.2.3 Low Discharge Pressure

Low discharge pressure can only be caused by loss of flow. Pump discharge pressure is caused only by the system's resistance to the flow provided by the pump. Either the pump is not providing the flow expected or the system is not offering the expected resistance to that flow. It is possible that flow is being restricted into the pump (cavitation), usually accompanied by noise and vibration, the pump is not producing its rated flow (pump worn or damaged), or the pump flow is bypassing rather than being delivered into the system as intended.

13.2.4 Excessive Noise or Vibration

Excessive noise and/or vibration can be a symptom of cavitation, mechanical damage to pump assembly, misalignment of drive or harmonics with other elements of the system. Cavitation is especially true if the discharge pressure is fluctuating or pulsating. Mechanical causes of noise and vibration include shaft misalignment, loose couplings, loose pump and/or driver mountings, loose pump and/or driver guards, worn or damaged driver or pump bearings or valve noise that seems to be coming from the pump. Valves, especially on the discharge side of the pump can sometimes go into a hydraulic vibration mode caused by operating pressure, flow rate and the valve design. Resetting or a change in an internal valve component is usually sufficient to solve the problem.

13.2.5 Excessive Power

Excessive power consumption can be caused by either mechanical or hydraulic problems. Mechanical causes include imminent bearing failure, pumping elements rubbing which can lead to a pump seizure and poor shaft alignments. Too high viscosity can result in the motor overloading.

- For a rotary lobe pump too high discharge pressure can cause the motor to overload.
- For a centrifugal pump too high capacity (too low discharge pressure) can cause the motor to overload.

13.2.6 Rapid Pump Wear

Rapid wear of pumphead components is either caused by abrasives being present in the fluid, chemical corrosion, loss of shaft support (bearing failure), or operation at a condition for which the pump is not suitable i.e. cavitation, excessively high pressure or high temperature. To avoid any abrasive foreign material entering the pump, strainers or filters should be employed wherever possible and practical. Rapid wear is sometimes not wear in the sense of a non-durable pump, but really a catastrophic pump failure that occurred very quickly. Looking at the pump internal parts alone may not provide much help in identifying the cause, thus the importance of knowing what was occurring in the time period immediately preceding detection of the problem.

13.2.7 Seal Leakage

Mechanical seals fitted to centrifugal, rotary lobe and liquid ring pumps can be seen as the weakest point for any pump leakage and special care should be taken to ensure the correct seal for the application is installed i.e. mounting attitude, seal face combination and elastomer selection.

Apart from mis-selection and poor servicing, seal leakage can be due to pump cavitation, too high discharge pressure, being allowed to run dry and unexpected solids in the fluid.

13.3 Problem Solving Table

The table shown offers probable causes and solutions to the most common problems encountered.

In () next to the particular solution given you will find annotation relating to what pump type the solution is for.

i.e. ce = Centrifugal Pump

 liq = Liquid Ring Pump

 rlp = Rotary Lobe Pump

See table 13.3a on the following pages:

Problem													ce = Centrifugal, liq = Liquid Ring, rlp = Rotary Lobe				
No flow	Under capacity	Irregular discharge	Low discharge pressure	Pump will not prime	Prime lost after starting	Pump stalls when starting	Pump overheats	Motor overheats	Excessive power absorbed	Noise and vibration	Pump element wear	Syphoning	Seizure	Mechanical seal leakage	Packed gland leakage	Probable Causes	Solutions
✓				✓												Incorrect direction of rotation.	Reverse motor (ce, liq, rlp).
✓																Pump not primed.	Expel gas from suction line and pumping chamber and introduce fluid (ce, liq, rlp).
✓	✓	✓	✓	✓					✓							Insufficient NPSH available.	Increase suction line diameter (ce, liq, rlp). Increase suction head (ce, liq, rlp). Simplify suction line configuration and reduce length (ce, liq, rlp). Reduce pump speed (rlp). Decrease fluid temperature (ce,liq) - check effect of increased viscosity?
✓	✓	✓	✓	✓					✓							Fluid vaporising in suction line.	Increase suction line diameter (ce, liq, rlp). Increase suction head (ce, liq, rlp). Simplify suction line configuration and reduce length (ce, liq, rlp). Reduce pump speed (rlp). Decrease fluid temperature (ce, liq) - check effect of increased viscosity?
✓	✓	✓	✓	✓	✓				✓							Air entering suction line.	Remake pipework joints (ce, rlp).
✓	✓	✓	✓	✓					✓							Strainer or filter blocked.	Service fittings (ce, liq, rlp).
	✓			✓	✓	✓	✓	✓	✓					✓		Fluid viscosity above rated figure.	Increase fluid temperature (ce, liq, rlp). Decrease pump speed (rlp). Increase motor speed (ce, liq). Check seal face viscosity limitations (ce, liq, rlp).
✓	✓	✓														Fluid viscosity below rated figure.	Decrease fluid temperature (ce, liq, rlp). Increase pump speed (rlp).
						✓		✓	✓	✓	✓	✓	✓			Fluid temp. above rated figure.	Cool the pump casing (ce, rlp). Reduce fluid temperature (ce, liq, rlp). Check seal face and elastomer temperature limitations (ce, liq, rlp).
						✓	✓	✓								Fluid temp. below rated figure.	Heat the pump casing (ce,rlp). Increase fluid temperature (ce,liq, rlp).
									✓	✓	✓	✓	✓			Unexpected solids in fluid.	Clean the system (ce, liq, rlp). Fit strainer to suction line (ce, liq, rlp). If solids cannot be eliminated, consider fitting double mechanical seals (ce, rlp).
✓	✓	✓		✓	✓	✓	✓	✓	✓	✓	✓	✓	✓	✓	✓	Discharge pressure above rated figure.	Check for obstructions i.e. closed valve (ce, liq, rlp). Service system and change to prevent problem recurring (ce, liq, rlp). Simplify discharge line to decrease pressure (ce, liq, rlp).
							✓	✓	✓				✓			Gland over-tightened.	Slacken and re-adjust gland packing (rlp).

Problem													ce = Centrifugal, liq = Liquid Ring, rlp = Rotary Lobe				
No flow	Under capacity	Irregular discharge	Low discharge pressure	Pump will not prime	Prime lost after starting	Pump stalls when starting	Pump overheats	Motor overheats	Excessive power absorbed	Noise and vibration	Pump element wear	Syphoning	Seizure	Mechanical seal leakage	Packed gland leakage	Probable Causes	Solutions
	✓	✓		✓					✓					✓		Gland under-tightened.	Adjust gland packing (rlp).
														✓	✓	Seal flushing inadequate.	Increase flush flow rate (ce,rlp). Check that flush fluid flows freely into seal area (ce, rlp).
	✓							✓	✓	✓						Pump speed above rated figure.	Decrease pump speed (rlp).
✓	✓															Pump speed below rated figure.	Increase pump speed (rlp).
	✓						✓	✓	✓	✓	✓		✓			Pump casing strained by pipework.	Check alignment of pipes (ce, liq, rlp). Fit flexible pipes or expansion fittings (ce, liq, rlp). Support pipework (ce, liq, rlp).
							✓		✓	✓			✓			Flexible coupling misaligned.	Check alignment and adjust mountings accordingly (rlp).
							✓	✓	✓	✓			✓			Insecure pump driver mountings.	Fit lock washers to slack fasteners and re-tighten (rlp).
							✓	✓	✓	✓			✓	✓	✓	Shaft bearing wear or failure.	Refer to pump maker for advice and replacement parts (rlp).
							✓	✓	✓	✓			✓			Insufficient gearcase lubrication.	Refer to pump maker's instructions (rlp).
✓	✓						✓	✓	✓	✓			✓			Metal to metal contact of pumping element.	Check rated and duty pressures (ce, liq, rlp). Refer to pump maker (ce, liq, rlp).
✓	✓	✓														Worn pumping element.	Fit new components (ce, liq, rlp).
✓	✓								✓							Rotorcase cover relief valve leakage.	Check pressure setting and re-adjust if necessary (rlp). Examine and clean seating surfaces (rlp). Replace worn parts (rlp).
	✓								✓							Rotorcase cover relief valve chatter.	Check for wear on sealing surfaces, guides etc - replace as necessary (rlp).
✓	✓															Rotorcase cover relief valve incorrectly set.	Re-adjust spring compression (rlp) - valve should lift approx. 10% above duty pressure.
✓			✓													Suction lift too high.	Lower pump or raise fluid level (ce, rlp).
														✓	✓	Fluid pumped not compatible with materials used.	Use optional materials (ce, liq, rlp).
													✓			No barrier in system to prevent flow passing back through pump.	Ensure discharge pipework higher than suction tank (rlp).
														✓	✓	Pump allowed to run dry.	Ensure system operation prevents this (ce, rlp). Fit single or double flushed mechanical seals (ce, rlp). Fit flushed packed gland (rlp).
								✓	✓							Faulty motor.	Check and replace motor bearings (ce, liq, rlp).
✓	✓															Too large clearance between impeller and back plate/casing.	Reduce clearance between impeller and back plate/casing (ce, liq).
✓	✓															Too small impeller diameter.	Fit larger size impeller - check motor size (ce).
✓																Pumping element missing i.e. after service.	Fit pumping element (ce, liq, rlp).

Table 13.3a

14. Technical Data

This section includes a summary of nomenclature and formulas used in this handbook. Various conversion tables and curves are also shown.

14.1 Nomenclature

Symbol	Description	Symbol	Description
A	Area	Q_L	Fluid losses through impeller casing clearances
D	Tube diameter	q	Pump displacement
F	Force	r	Radius
f_D	Darcy friction factor	Ra	Surface roughness
g	Gravity	Re	Reynolds number
H	Total head	SG	Specific gravity
H_s	Total suction head	T	Shaft torque
H_t	Total discharge head	V	Fluid velocity
h_{fs}	Pressure drop in suction line	γ (Greek letter 'gamma')	Specific weight
h_{ft}	Pressure drop in discharge line	Δ (Greek letter 'delta')	Total
h_s	Static suction head	ϵ (Greek letter 'epsilon')	Relative roughness
h_t	Static discharge head	η (Greek letter 'eta')	Total efficiency
L	Tube length	η_h	Hydraulic efficiency
n	Pump speed	η_m	Mechanical efficiency
Pa	Pressure absolute above fluid level	η_{ca}	Overall efficiency
P_f	Pressure loss due to friction	η_v	Volumetric efficiency
P_s	Vacuum or pressure in a tank on suction side	μ (Greek letter 'mu')	Absolute viscosity
P_t	Pressure in a tank on discharge side	ν (Greek letter 'nu')	Kinematic viscosity
Pv	Power/viscosity factor	ρ (Greek letter 'rho')	Fluid density
Pvp	Vapour pressure	ω (Greek letter 'omega')	Shaft angular velocity
Q	Capacity		

Table 14.1a

14.2 Formulas

Designation	Formula	Comments	Where to find
Product			
Viscosity	$\nu = \frac{\mu}{\rho}$	where: ν = Kinematic viscosity (mm ² /s) μ = Absolute viscosity (mPa.s) ρ = fluid density (kg/m ³)	2.1.2
	or		
	$\nu = \frac{\mu}{SG}$	where: ν = Kinematic viscosity (cSt) μ = Absolute viscosity (cP) SG = specific gravity	
	or		
	$\mu = \nu \times SG$	1 Poise = 100 cP 1 Stoke = 100 cSt	
Flow			
Velocity	$V = \frac{Q}{A}$	where: V = fluid velocity (m/s) Q = capacity (m ³ /s) A = tube area (m ²)	2.1.7
	or		
	$V = \frac{Q \times 353.6}{D^2}$	where: V = fluid velocity (m/s) Q = capacity (m ³ /h) D = tube diameter (mm)	
	or		
	$V = \frac{Q \times 0.409}{D^2}$	where: V = fluid velocity (ft/s) Q = capacity (US gall/min) D = tube diameter (in)	
	or		
	$V = \frac{Q \times 0.489}{D^2}$	where: V = fluid velocity (ft/s) Q = capacity (UK gall/min) D = tube diameter (in)	
Reynolds number (ratio of inertia forces to viscous forces)	$Re = \frac{D \times V \times \rho}{\mu}$	where: D = tube diameter (m) V = fluid velocity (m/s) ρ = density (kg/m ³) μ = absolute viscosity (Pa.s)	2.1.7
	or		
	$Re = \frac{D \times V \times \rho}{\mu}$	where: D = tube diameter (mm) V = fluid velocity (m/s) ρ = density (kg/m ³) μ = absolute viscosity (cP)	
	or		
	$Re = \frac{21230 \times Q}{D \times \mu}$	where: D = tube diameter (mm) Q = capacity (l/min) μ = absolute viscosity (cP)	

Designation	Formula	Comments	Where to find
Reynolds number (ratio of inertia forces to viscous forces)	$Re = \frac{3162 \times Q}{D \times \nu}$ or $Re = \frac{3800 \times Q}{D \times \nu}$	where: D = tube diameter (in) Q = capacity (US gall/min) ν = kinematic viscosity (cSt) where: D = tube diameter (in) Q = capacity (UK gall/min) ν = kinematic viscosity (cSt)	
Pressure/Head			
Pressure (total force per unit area exerted by a fluid)	$P = \frac{F}{A}$	where: F = Force A = Area	2.2.2
Static Pressure/Head (relationship between pressure and elevation)	$P = \rho \times g \times h$ or $P = \frac{h \times SG}{10}$ or $P = \frac{h \times SG}{2.31}$	where: P = pressure/head (Pa) ρ = fluid density (kg/m ³) g = acceleration due to gravity (m/s ²) h = height of fluid (m) where: P = pressure/head (bar) h = height of fluid (m) where: P = pressure/head (psi) h = height of fluid (ft)	2.2.2
Total head	$H = H_t - (\pm H_s)$	where: H _t = total discharge head H _s = total suction head	2.2.2
Total discharge head	$H_t = h_t + h_{rt} + p_t$	where: h _t = static discharge head h _{rt} = pressure drop in discharge line p _t > 0 for pressure p _t < 0 for vacuum p _t = 0 for open tank	2.2.2
Total suction head	$H_s = h_s - h_{rs} + (\pm p_s)$	where: h _s = static suction head > 0 for flooded suction < 0 for suction lift h _{rs} = pressure drop in suction line p _s > 0 for pressure p _s < 0 for vacuum p _s = 0 for open tank	2.2.2
Friction loss (Miller equation)	$P_f = \frac{f_D \times L \times \rho \times V^2}{D \times 2}$	where: P _f = friction loss (Pa) f _D = friction factor (Darcy) L = tube length (m) V = fluid velocity (m/s) ρ = fluid density (kg/m ³) D = tube diameter (m)	2.2.2

Designation	Formula	Comments	Where to find
Friction loss (Miller equation)	$Pf = \frac{5 \times SG \times f_D \times L \times V^2}{D}$ <p style="text-align: center;">or</p> $Pf = \frac{0.0823 \times SG \times f_D \times L \times V^2}{D}$	<p>where:</p> <p>Pf = friction loss (bar)</p> <p>f_D = friction factor (Darcy)</p> <p>L = tube length (m)</p> <p>V = fluid velocity (m/s)</p> <p>SG = specific gravity</p> <p>D = tube diameter (mm)</p> <p>where:</p> <p>Pf = friction loss (psi)</p> <p>f_D = friction factor (Darcy)</p> <p>L = tube length (ft)</p> <p>V = fluid velocity (ft/s)</p> <p>SG = specific gravity</p> <p>D = tube diameter (in)</p>	
Darcy friction factor	$f_D = \frac{64}{Re}$	<p>where:</p> <p>f_D = friction factor</p> <p>Re = Reynolds number</p>	2.2.2
NPSHa (Net Positive Suction Head available)	$NPSHa = Pa \pm h_s - h_{fs} - Pvp$ <p>(+h_s for flooded suction) (- h_s for suction lift)</p>	<p>where:</p> <p>Pa = pressure absolute above fluid level (bar)</p> <p>h_s = static suction head (m)</p> <p>h_{fs} = pressure drop in suction line (m)</p> <p>Pvp = vapour pressure (bar a)</p> <p style="text-align: center;">or</p> <p>where:</p> <p>Pa = pressure absolute above fluid level (psi)</p> <p>h_s = static suction head (ft)</p> <p>h_{fs} = pressure drop in suction line (ft)</p> <p>Pvp = vapour pressure (psia)</p>	2.2.4
Power			
Hydraulic power (theoretical energy required)	$\text{Power (W)} = Q \times H \times \rho \times g$ $\text{Power (kW)} = \frac{Q \times H}{k}$ $\text{Power (hp)} = \frac{Q \times H}{k}$ $\text{Power (hp)} = \frac{Q \times H}{k}$	<p>where:</p> <p>Q = capacity (m³/s)</p> <p>H = total head (m)</p> <p>ρ = fluid density (kg/m³)</p> <p>g = acceleration due to gravity (m/s²)</p> <p>where:</p> <p>Q = capacity (l/min)</p> <p>H = total head (bar)</p> <p>k = 600</p> <p>where:</p> <p>Q = capacity (US gall/min)</p> <p>H = total head (psi)</p> <p>k = 1715</p> <p>where:</p> <p>Q = capacity (UK gall/min)</p> <p>H = total head (psi)</p> <p>k = 1428</p>	7.2.1

Designation	Formula	Comments	Where to find
Required power (power needed at the pump shaft)	<u>Hydraulic power</u> Efficiency (100% = 1.0)		7.2.2
Torque			
Torque	Torque (Nm) = <u>Required power (kW) x 9550</u> Pump speed (rev/min) or Torque (Kgfm) = <u>Required power (kW) x 974</u> Pump speed (rev/min) or <u>Torque (ftlb) =</u> <u>Required power (hp) x 5250</u> Pump speed (rev/min)		7.2.3
Efficiency			
Hydraulic efficiency (η_h)	<u>Pump head loss (m)</u> x 100% Total head (m)		7.2.4
Mechanical efficiency (η_m)	1 - <u>Pump mech. losses</u> x 100% Required power		7.2.4
Volumetric efficiency (Centrifugal and Liquid Ring pumps)	$\eta_v = \frac{Q}{Q + Q_L} \times 100\%$	where: η_v = volumetric efficiency Q = pump capacity Q_L = fluid losses due to leakage through the impeller casing clearances	7.2.4
Volumetric efficiency (Rotary Lobe pumps)	$\eta_v = \frac{Q}{q} \times 100\%$	where: η_v = volumetric efficiency Q = pump capacity q = pump displacement	7.2.4
Pump efficiency (η_p)	<u>Water horse power</u> x 100% Required power or $\eta_p = \frac{Q \times H \times \rho \times g}{\omega \times T}$	where: η_p = pump efficiency Q = capacity (m ³ /s) H = total head/pressure (m) ρ = fluid density (kg/m ³) g = acceleration due to gravity (m/s ²) ω = shaft angular velocity (rad/s) T = shaft torque (Nm)	7.2.4
Overall efficiency (η_{os})	<u>Water horse power</u> x 100% Drive power		7.2.4

Designation	Formula	Comments	Where to find
Pump speed - Rotary Lobe Pump			
Pump speed	$n = \frac{Q \times 100}{q \times \eta_v \times 60}$	where: n = pump speed (rev/min) Q = capacity (m ³ /h) q = pump displacement (m ³ /100 rev) η _v = vol. efficiency (100% = 1.0)	7.2.4
	or $n = \frac{Q \times 100}{q \times \eta_v}$	where: n = pump speed (rev/min) Q = capacity (US gall/min) q = pump displacement (US gall/100 rev) η _v = vol. efficiency (100% = 1.0)	
	or $n = \frac{Q \times 100}{q \times \eta_v}$	where: n = pump speed (rev/min) Q = capacity (UK gall/min) q = pump displacement (UK gall/100 rev) η _v = vol. efficiency (100% = 1.0)	
Flow Control - Centrifugal Pump			
Connection between impeller diameter and capacity	$D_2 = D_1 \times \sqrt[3]{\frac{Q_2}{Q_1}}$	where: D = impeller diameter (mm) Q = capacity (m ³ /h)	7.3.2
Connection between impeller diameter and head	$D_2 = D_1 \times \sqrt{\frac{H_2}{H_1}}$	where: D = impeller diameter (mm) H = head (m)	7.3.2
Connection between impeller diameter and power	$D_2 = D_1 \times \sqrt[5]{\frac{P_2}{P_1}}$	where: D = impeller diameter (mm) P = power (kW)	7.3.2
Reduction of multi-stage impeller diameter	$D_2 = D_1 \times \sqrt{\frac{c-b}{a-b}}$	where: D ₁ = standard diameter (mm) a = max. working point (m) b = min. working point (m) c = required working point (m)	7.3.2
Connection between impeller speed and capacity	$n_2 = n_1 \times \frac{Q_2}{Q_1}$	where: n = impeller speed (rev/min) Q = capacity (m ³ /h)	7.3.2
Connection between impeller speed and head	$n_2 = n_1 \times \sqrt{\frac{H_2}{H_1}}$	where: n = impeller speed (rev/min) H = head (m)	7.3.2
Connection between impeller speed and power	$n_2 = n_1 \times \sqrt[3]{\frac{P_2}{P_1}}$	where: n = impeller speed (rev/min) P = power (kW)	7.3.2

Table 14.2a

14.3 Conversion tables

14.3.1 Length

mm	m	cm	in	ft	yd
1.0	0.001	0.10	0.0394	0.0033	0.0011
1000	1.0	100	39.370	3.2808	1.0936
10	0.01	1.0	0.3937	0.0328	0.1094
25.4	0.0254	2.540	1.0	0.0833	0.0278
304.8	0.3048	30.48	12	1.0	0.3333
914.4	0.9144	91.441	36	3.0	1.0

Table 14.3.1a

14.3.2 Volume

m ³	cm ³	l	in ³	ft ³	UK gall.	US gall.
1.0	100 x 10 ⁴	1000	61024	35.315	220.0	264.0
10 x 10 ⁷	1.0	10 x 10 ⁻⁴	0.0610	3.53 x 10 ⁻⁵	22 x 10 ⁻⁵	26.4 x 10 ⁻⁵
0.0010	1000	1.0	61.026	0.0353	0.22	0.2642
1.64 x 10 ⁻⁵	16.387	0.0164	1.0	58 x 10 ⁻⁵	0.0036	0.0043
00283	28317	28.317	1728	1.0	6.2288	7.4805
0.0045	4546.1	4.546	277.42	0.1605	1.0	1.201
37.88 x 10 ⁻⁴	3785.4	3.7853	231.0	0.1337	0.8327	1.0

Table 14.3.2a

14.3.3 Volumetric Capacity

m ³ /h	l/min	hl/h	UK gall/min	US gall/min	ft ³ /h	ft ³ /s	m ³ /s
1.0	16.667	10.0	3.6667	4.3999	35.315	9.81 x 10 ⁻³	2.78 x 10 ⁻⁴
0.060	1.0	0.60	0.22	0.2642	2.1189	5.88 x 10 ⁻⁴	1.67 x 10 ⁻⁵
0.10	1.6667	1.0	0.3667	0.4399	3.5315	9.81 x 10 ⁻⁴	2.78 x 10 ⁻⁵
0.2727	4.546	2.7270	1.0	1.201	9.6326	2.67 x 10 ⁻³	7.57 x 10 ⁻⁵
0.2273	3.785	2.2732	0.8326	1.0	8.0208	2.23 x 10 ⁻³	6.31 x 10 ⁻⁵
0.0283	0.4719	0.2832	0.1038	0.1247	1.0	2.78 x 10 ⁻⁴	7.86 x 10 ⁻⁶
101.94	1699	1019.4	373.73	448.83	3600	1.0	0.0283
3600	6 x 10 ⁴	36000	13200	15838	127208	35.315	1.0

Table 14.3.3a

14.3.4 Mass Capacity

kg/s	kg/h	lb/h	UK ton/h	t/d (tonne/day)	t/h (tonne/hour)	lb/s
1.0	3600	7936.6	3.5431	86.40	3.6	2.2046
2.78×10^{-4}	1.0	2.2046	98.4×10^{-5}	0.024	0.001	6.12×10^{-4}
1.26×10^{-4}	0.4536	1.0	44.6×10^{-5}	0.0109	4.54×10^{-4}	2.78×10^{-4}
0.2822	1016.1	2240	1.0	24.385	1.0160	0.6222
11.57×10^{-3}	41.667	91.859	0.0410	1.0	0.0417	0.0255
0.2778	1000	2201.8	0.9842	24	1.0	0.6116
0.4536	1632.9	3600	1.6071	39.190	1.6350	1.0

Table 14.3.4a

14.3.5 Pressure/Head

bar	kg/cm ²	lb/in ² (psi)	atm (water)	ft (water)	m	mm Hg	in Hg	kPa
1.0	1.0197	14.504	0.9869	33.455	10.197	750.06	29.530	100
0.9807	1.0	14.223	0.9878	32.808	10	735.56	28.959	98.07
0.0689	0.0703	1.0	0.0609	2.3067	0.7031	51.715	2.036	6.89
1.0133	1.0332	14.696	1.0	33.889	10.332	760.0	29.921	101.3
0.0299	0.0305	0.4335	0.0295	1.0	0.3048	22.420	0.8827	2.99
0.0981	0.10	1.422	0.0968	3.2808	1.0	73.356	2.896	9.81
13.3×10^{-4}	0.0014	0.0193	13.2×10^{-4}	0.0446	0.0136	1.0	0.0394	0.133
0.0339	0.0345	0.4912	0.0334	1.1329	0.3453	25.40	1.0	3.39
1.0×10^{-5}	10.2×10^{-6}	14.5×10^{-5}	9.87×10^{-6}	3.34×10^{-4}	10.2×10^{-5}	75.0×10^{-4}	29.5×10^{-5}	1.0

Table 14.3.5a

14.3.6 Force

Table 14.3.6a

kN	kgf	lbf
1.0	101.97	224.81
9.81×10^{-3}	1.0	2.2046
44.5×10^{-4}	0.4536	1.0

14.3.7 Torque

Table 14.3.7a

Nm	kgfm	lbft	lbin
1.0	0.102	0.7376	8.8508
9.8067	1.0	7.2330	86.796
1.3558	0.1383	1.0	12.0
0.113	0.0115	0.0833	1.0

14.3.8 Power

W	kgfm/s	ft lbf/s	hp	kW
1.0	0.102	0.7376	1.34×10^{-3}	1000
9.8067	1.0	7.2330	0.0132	9806.7
1.3558	0.1383	1.0	1.82×10^{-3}	1355.8
745.70	76.040	550.0	1.0	74.6×10^{-4}
0.001	10.2×10^{-5}	73.8×10^{-5}	13.4×10^{-7}	1.0

Table 14.3.8a

14.3.9 Density

Table 14.3.9a

kg/m ³	g/cm ³	lb/in ³	lb/ft ³
1	10^{-3}	36.127×10^{-6}	62.428×10^{-3}
10^3	1	36.127×10^{-3}	62.428
27.680×10^3	27.680	1	1.728×10^3
16.019	16.019×10^{-3}	$0.578 \ 70 \times 10^{-3}$	1

14.3.10 Viscosity Conversion Table

When SG = 1.0 Read Directly Across		When SG is other than 1.0											
cP	Poise	Find cSt, then multiply cSt x SG = cP		Saybolt Universal SSU	Seconds Engler	Redwood Standard #1	Ford #3	Ford #4	Zahn #1	Zahn #2	Zahn #3	Zahn #4	Zahn #5
		cSt	Stoke										
1	0.01	1	0.01	31	54	29							
2	0.02	2	0.02	34	57	32							
4	0.04	4	0.04	38	61	36							
7	0.07	7	0.07	47	75	44	8						
10	0.10	10	0.10	60	94	52	9	5	30	16			
15	0.15	15	0.15	80	125	63	10	8	34	17			
20	0.20	20	0.20	100	170	86	12	10	37	18			
25	0.25	25	0.25	130	190	112	15	12	41	19			
30	0.30	30	0.30	160	210	138	19	14	44	20			
40	0.40	40	0.40	210	300	181	25	18	52	22			
50	0.50	50	0.50	260	350	225	29	22	60	24			
60	0.60	60	0.60	320	450	270	33	25	68	27			
70	0.70	70	0.70	370	525	314	36	28	72	30			
80	0.80	80	0.80	430	600	364	41	31	81	34			
90	0.90	90	0.90	480	875	405	45	32	88	37	10		
100	1.0	100	1.0	530	750	445	50	34	41	12	10		
120	1.2	120	1.2	580	900	492	58	41	49	14	11		
140	1.4	140	1.4	690	1050	585	66	45	58	16	13		
160	1.6	160	1.6	790	1200	670	72	50	66	18	14		
180	1.8	180	1.8	900	1350	762	81	54	74	20	16		
200	2.0	200	2.0	1000	1500	817	90	58	82	23	17	10	
220	2.2	220	2.2	1100	1650	933	98	62	88	25	18	11	
240	2.4	240	2.4	1200	1800	1020	106	65	27	20	12		
260	2.6	260	2.6	1280	1950	1085	115	68	30	21	13		
280	2.8	280	2.8	1380	2100	1170	122	70	32	22	14		
300	3.0	300	3.0	1475	2250	1250	130	74	34	24	15		
320	3.2	320	3.2	1530	2400	1295	136	89	36	25	16		
340	3.4	340	3.4	1630	2550	1380	142	95	39	26	17		
360	3.6	360	3.6	1730	2700	1465	150	100	41	27	18		
380	3.8	380	3.8	1850	2850	1570	160	106	43	29	19		
400	4.0	400	4.0	1950	3000	1650	170	112	46	30	20		
420	4.2	420	4.2	2050	3150	1740	180	118	48	32	21		
440	4.4	440	4.4	2160	3300	1830	188	124	50	33	22		
460	4.6	460	4.6	2270	3450	1925	200	130	52	34	23		
480	4.8	480	4.8	2380	3600	2020	210	137	54	36	24		
500	5.0	500	5.0	2480	3750	2100	218	143	58	38	25		
550	5.5	550	5.5	2660	4125	2255	230	153	64	40	27		
600	6.0	600	6.0	2900	4500	2460	250	170	68	45	30		
700	7.0	700	7.0	3380	5250	2860	295	194	76	51	35		
800	8.0	800	8.0	3880	6000	3290	340	223		57	40		
900	9.0	900	9.0	4300	8750	3640	365	247		63	45		
1000	10	1000	10	4600	7500	3900	390	264		69	49		

When SG = 1.0 Read Directly Across		When SG is other than 1.0											
cP	Poise	Find cSt, then multiply cSt x SG = cP		Saybolt Universal SSU	Seconds Engler	Redwood Standard #1	Ford #3	Ford #4	Zahn #1	Zahn #2	Zahn #3	Zahn #4	Zahn #5
		cSt	Stoke										
1100	11	1100	11	5200	8250	4410	445	299				77	55
1200	12	1200	12	5620	9000	4680	480	323					59
1300	13	1300	13	6100	9750	5160	520	350					64
1400	14	1400	14	6480	10350	5490	550	372					70
1500	15	1500	15	7000	11100	5940	595	400					75
1600	16	1600	16	7500	11850	6350	635	430					80
1700	17	1700	17	8000	12600	6780	680	460					85
1800	18	1800	18	8500	13300	7200	720	490					91
1900	19	1900	19	9000	13900	7620	760	520					96
2000	20	2000	20	9400	14600	7950	800	540					
2100	21	2100	21	9850	15300	8350	835	565					
2200	22	2200	22	10300	16100	8730	875	592					
2300	23	2300	23	10750	16800	9110	910	617					
2400	24	2400	24	11200	17500	9500	950	645					
2500	25	2500	25	11600	18250	9830	985	676					
3000	30	3000	30	14500	21800	12300	1230	833					
3500	35	3500	35	16500	25200	14000	1400	950					
4000	40	4000	40	18500	28800	15650	1570	1060					
4500	45	4500	45	21000	32400	17800		1175					
5000	50	5000	50	23500	36000	19900		1350					
5500	55	5500	55	26000	39600			1495					
6000	60	6000	60	28000	43100			1605					
6500	65	6500	65	30000	46000			1720					
7000	70	7000	70	32500	49600			1870					
7500	75	7500	75	35000	53200			2010					
8000	80	8000	80	37000	56800			2120					
8500	85	8500	85	39500	60300			2270					
9000	90	9000	90	41080	63900			2350					
9500	95	9500	95	43000	67400			2470					
10000	100	10000	100	46500	71000			2670					
15000	150	15000	150	69400	106000								
20000	200	20000	200	92500	140000								
30000	300	30000	300	138500	210000								
40000	400	40000	400	185000	276000								
50000	500	50000	500	231000	345000								
60000	600	60000	600	277500	414000								
70000	700	70000	700	323500	484000								
80000	800	80000	800	370000	550000								
90000	900	90000	900	415500	620000								
100000	1000	100000	1000	462000	689000								
125000	1250	125000	1250	578000	850000								
150000	1500	150000	1500	694000									
175000	1750	175000	1750	810000									
200000	2000	200000	2000	925000									

Table 14.3.10a

14.3.11 Temperature Conversion Table

minus 459.4 - 0			0 - 49			50 - 100			100 - 490			500 - 1000		
°C	to	°F	°C	to	°F	°C	to	°F	°C	to	°F	°C	to	°F
-273	-459		-17.8	0	32	10.0	50	122.0	38	100	212	260	500	932
-268	-450		-17.2	1	33.8	10.6	51	123.8	43	110	230	266	510	950
-262	-440		-16.7	2	35.6	11.1	52	125.6	49	120	248	271	520	968
-257	-430		-16.1	3	37.4	11.7	53	127.4	54	130	266	277	530	986
-251	-420		-15.6	4	39.2	12.2	54	129.2	60	140	284	282	540	1004
-246	-410		-15.0	5	41.0	12.8	55	131.0	66	150	302	288	550	1022
-240	-400		-14.4	6	42.8	13.3	56	132.8	71	160	320	293	560	1040
-234	-390		-13.9	7	44.6	13.9	57	134.6	77	170	338	299	570	1058
-229	-380		-13.3	8	46.4	14.4	58	136.4	82	180	356	304	580	1076
-223	-370		-12.8	9	48.2	15.0	59	138.2	88	190	374	310	590	1094
-218	-360		-12.2	10	50.0	15.6	60	140.0	93	200	392	316	600	1112
-212	-350		-11.7	11	51.8	16.1	61	141.8	99	210	410	321	610	1130
-207	-340		-11.1	12	53.6	16.7	62	143.6	100	212	414	327	620	1148
-201	-330		-10.6	13	55.4	17.2	63	145.4	104	220	428	332	630	1166
-196	-320		-10.0	14	57.2	17.8	64	147.2	110	230	446	338	640	1184
-190	-310		-9.4	15	59.0	18.3	65	149.0	116	240	464	343	650	1202
-184	-300		-8.9	16	60.8	18.9	66	150.8	121	250	482	349	660	1220
-179	-290		-8.3	17	62.6	19.4	67	152.6	127	260	500	354	670	1238
-173	-280		-7.8	18	64.4	20.0	68	154.4	132	270	518	360	680	1256
-169	-273	-459.4	-7.2	19	66.2	20.6	69	156.2	138	280	536	366	690	1274
-168	-270	-454	-6.7	20	68.0	21.1	70	158.0	143	290	554	371	700	1292
-162	-260	-436	-6.1	21	69.8	21.7	71	159.8	149	300	572	377	710	1310
-157	-250	-418	-5.6	22	71.6	22.2	72	161.6	154	310	590	382	720	1328
-151	-240	-400	-5.0	23	73.4	22.8	73	163.4	160	320	608	388	730	1346
-146	-230	-382	-4.4	24	75.2	23.3	74	165.2	166	330	626	393	740	1364
-140	-220	-364	-3.9	25	77.0	23.9	75	167.0	171	340	644	399	750	1382
-134	-210	-346	-3.3	26	78.8	24.4	76	168.8	177	350	662	404	760	1400
-129	-200	-328	-2.8	27	80.6	25.0	77	170.6	182	360	680	410	770	1418
-123	-190	-310	-2.2	28	82.4	25.6	78	172.4	188	370	698	416	780	1436
-118	-180	-292	-1.7	29	84.2	26.1	79	174.2	193	380	716	421	790	1454
-112	-170	-274	-1.1	30	86.0	26.7	80	176.0	199	390	734	427	800	1472
-107	-160	-256	-0.6	31	87.8	27.2	81	177.8	204	400	752	432	810	1490
-101	-150	-238	0.0	32	89.6	27.8	82	179.6	210	410	770	438	820	1508
-96	-140	-220	0.6	33	91.4	28.3	83	181.4	216	420	788	443	830	1526
-90	-130	-202	1.1	34	93.2	28.9	84	183.2	221	430	806	449	840	1544
-84	-120	-184	1.7	35	95.0	29.4	85	185.0	227	440	824	454	850	1562
-79	-110	-166	2.2	36	96.8	30.0	86	186.8	232	450	842	460	860	1580
-73	-100	-148	2.8	37	98.6	30.6	87	188.6	238	460	860	466	870	1598
-68	-90	-130	3.3	38	100.4	31.1	88	190.4	243	470	878	471	880	1616
-62	-80	-112	3.9	39	102.2	31.7	89	192.2	249	480	896	477	890	1634
-57	-70	-94	4.4	40	104.0	32.2	90	194.0	254	490	914	482	900	1652
-51	-60	-76	5.0	41	105.8	32.8	91	195.8				488	910	1670
-46	-50	-58	5.6	42	107.6	33.3	92	197.6				493	920	1688
-40	-40	-40	6.1	43	109.4	33.9	93	199.4				499	930	1706
-34	-30	-22	6.7	44	111.2	34.4	94	201.2				504	940	1724
-29	-20	-4	7.2	45	113.0	35.0	95	203.0				510	950	1742
-23	-10	14	7.8	46	114.8	35.6	96	204.8				516	960	1760
-17.8	0	32	8.3	47	116.6	36.1	97	206.6				521	970	1778
			8.9	48	118.4	36.7	98	208.4				527	980	1796
			9.4	49	120.2	37.2	99	210.2				532	990	1814
						37.8	100	212.0				538	1000	1832

Locate temperature in middle column. If in °C read the °F equivalent in the right hand column. If in °F read °C equivalent in the left hand column.

°C = (°F - 32) x 0.5556 °F = (°C x 1.8) + 32

Table 14.3.11a

14.4 Water Vapour Pressure Table

Table 14.4a

Temp. (°C)	Density (ρ) (kg/m ³)	Vapour pressure (Pvp) (kPa)
0	999.8	0.61
5	1000.0	0.87
10	999.7	1.23
15	999.1	1.71
20	998.2	2.33
25	997.1	3.40
30	995.7	4.25
35	994.1	5.62
40	992.2	7.38
45	990.2	9.60
50	988.0	12.3
55	985.7	15.7
60	983.2	19.9
65	980.6	25.1
70	977.8	31.2
75	974.9	38.6
80	971.8	47.5
85	968.6	57.9
90	965.3	70.1
95	961.9	84.7
100	958.4	101.3
Vapour pressure: 1 bar = 100 kPa = 10 ⁵ N/m ²		

14.5 Pressure Drop Curve for 100 m ISO/DIN Tube

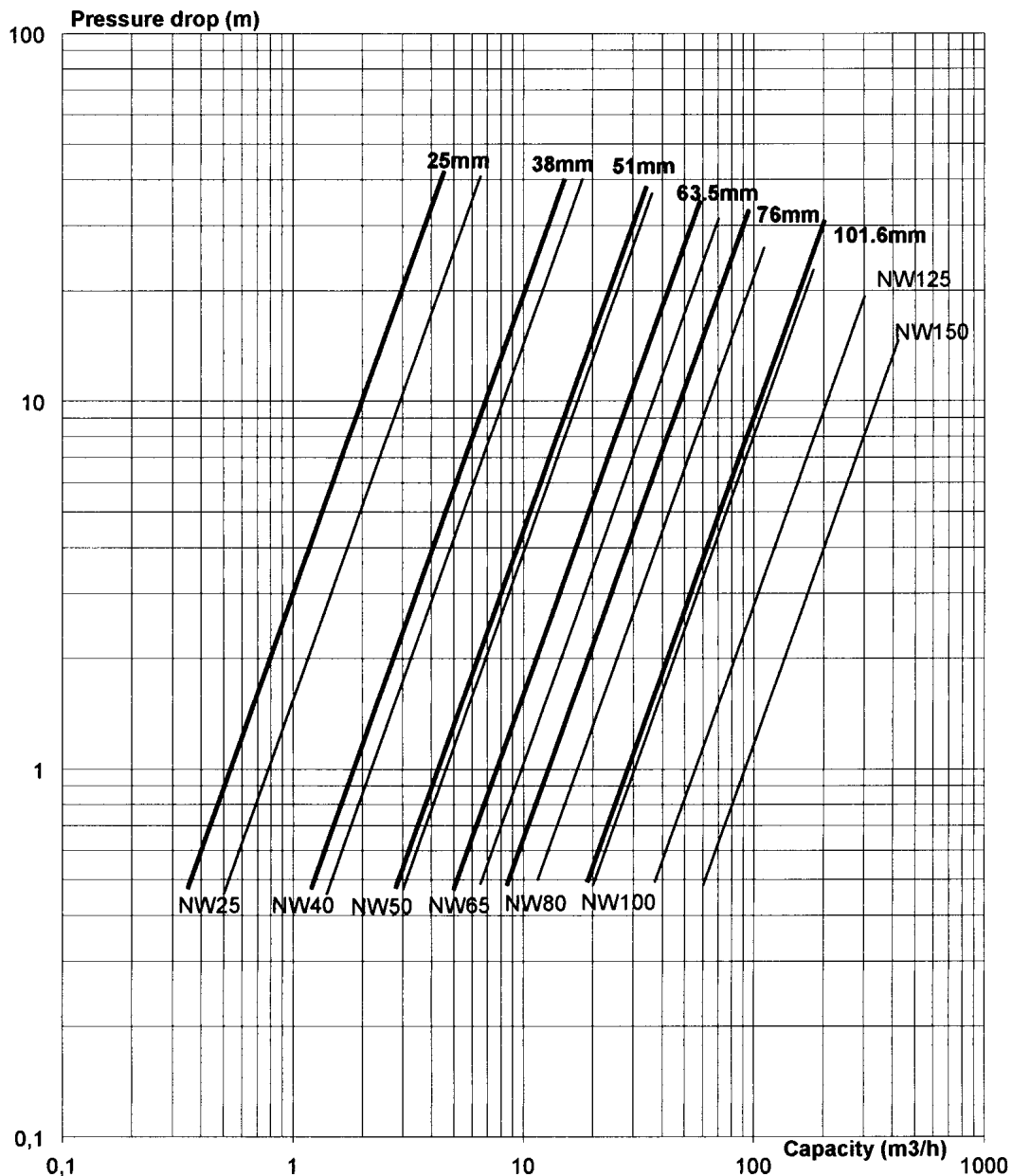

1 bar ≈ 10 m (metre liquid column)

Fig. 14.5a Pressure Drop Curve

14.6 Velocity (m/s) in ISO and DIN Tubes at various Capacities

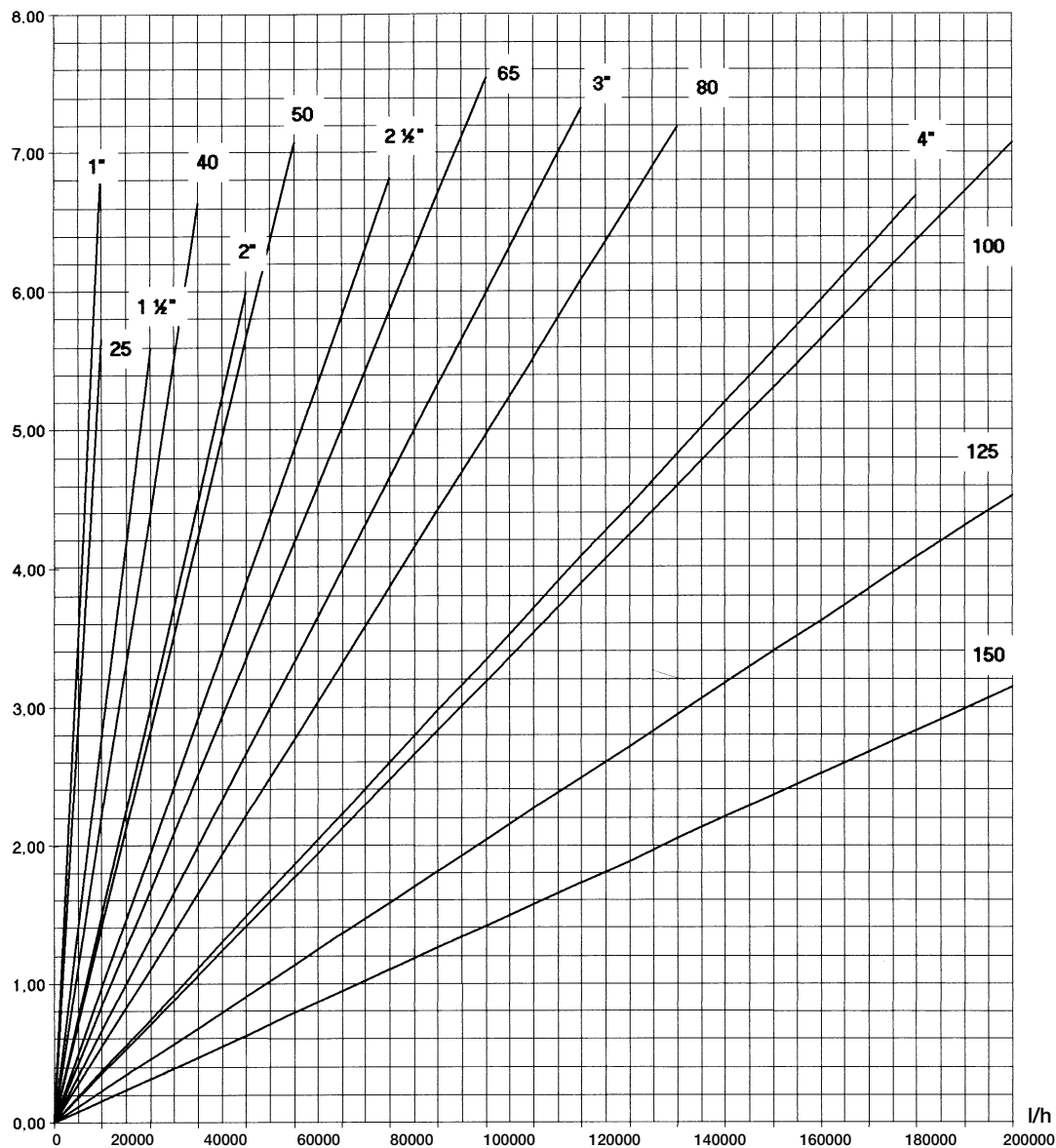





















































1 m³/h = 1000 l/h

Fig. 14.6a Connection between velocity and capacity at different tube dimensions

14.7 Equivalent Tube Length Table

14.7.1 ISO Tube Metric

























Equipment for ISO tube (for water at 2 m/s)	Equivalent tube length in metres per unit					
	25 mm	38 mm	51 mm	63.5 mm	76 mm	101.6 mm
Seat valves						
1. SRC, SMO 		7	6	12	21	30
2. 		5	4	6	14	19
3. 		4	10	12	15	29
4. 		3	4	7	12	26
5. 		5	14	27	32	50
6. 		5	10	21	22	39
1. SRC-LS 			7	12	11	8
2. 			3	8	7	6
3. 			7	8	9	14
4. 			5	4	6	11
5. 			8	13	13	19
6. 			7	10	11	17
Aseptic seat valves						
1. ARC, AMO 		7	13	28	43	55
2. 		5	9	21	27	36
3. 		4	10	20	32	55
4. 		4	8	15	29	39
5. 		6	18	37	61	88
6. 		5	15	28	50	75
1. ARC-SB 		8	15	20		
2. 		8	15	20		
3. 		6	10	18		
4. 		8	17	44		
Other valves						
Non-return valve LKC-2 	7	10	12	21	20	26
Butterfly valve LKB 	1	1	1	1	2	2
1. Koltek MH 	1	2	3	5	6	7
2. 	1	2	4	6	9	10



























Equipment for ISO tube (for water at 2 m/s)	Equivalent tube length in metres per unit					
	25 mm	38 mm	51 mm	63.5 mm	76 mm	101.6 mm
Mixproof valves						
1. <i>Unique</i> *		14	14	27	25	26
2.		14	14	27	25	26
3.		5	4	6	5	4
4.		6	5	7	7	5
1. SMP-SC			14	17	32	55
2.			14	16	25	41
3.			4	4	5	5
4.			4	5	5	14
1. SMP-SC, 3-body			8	14	27	45
2.			8	16	29	52
1. SMP-BC		3	3	4	3	6
2.		3	6	11	8	18
3.		3	5	7	7	11
4.		7	11	13	15	32
5.		6	10	13	14	31
6.		9	12	34	25	101
7.		6	12	34	23	101
1. SMP-BCA		2	3	4	3	6
2.		5	10	18	29	84
3.		3	9	16	29	81
4.		6	18	30	41	104
5.		5	12	20	27	75
6.		5	14	41	41	152
7.		6	14	34	38	146
1. SMP-TO				5		6
2.				8		23
3.				5		24
Tubes and fittings						
Bend 90 deg.	0.3	1	1	1	1	2
Bend 45 deg.	0.2	0.4	1	1	1	1
Tee (out through side port)	1	2	3	4	5	7
Tee (in through side port)	1	2	2	3	4	5

* Pressure drop/equivalent tube length is for unbalanced upper plug and balanced lower plug.
For other combinations use the CAS *Unique* configuration tool.

Table 14.7.1a

14.7.2 ISO Tube Feet

























Equipment for ISO tube (for water at 6 ft/s)	Equivalent tube length in feet per unit					
	1 in	1.5 in	2 in	2.5 in	3 in	4 in
Seat valves						
1. SRC, SMO 		23	20	39	69	98
2. 		16	13	20	46	62
3. 		13	33	39	49	95
4. 		10	13	23	39	85
5. 		16	46	89	105	164
6. 		16	33	69	72	128
Seat valves						
1. SRC-LS 			23	39	36	26
2. 			10	26	23	20
3. 			23	26	30	46
4. 			16	13	20	36
5. 			26	43	43	62
6. 			23	33	36	56
Seat valves						
1. ARC, AMO 		23	43	92	141	180
2. 		16	30	69	89	118
3. 		13	33	66	105	180
4. 		13	26	49	95	128
5. 		20	59	121	200	289
6. 		16	49	92	164	246
Seat valves						
1. ARC-SB 		26	49	66		
2. 		26	49	66		
3. 		20	33	59		
4. 		26	56	144		
Other valves						
Non-return valve LKC-2	23	33	39	69	66	85
Butterfly valve LKB	3	3	3	3	7	7
1. Koltek MH 	3	7	10	16	20	23
2. 	3	7	13	20	30	33



























Equipment for ISO tube (for water at 6 ft/s)	Equivalent tube length in feet per unit					
	1 in	1.5 in	2 in	2.5 in	3 in	4 in
Mixproof valves						
1. Unique *		46	46	89	82	85
2.		46	46	89	82	85
3.		16	13	20	16	13
4.		20	16	23	23	16
1. SMP-SC			46	56	105	180
2.			46	52	82	135
3.			13	13	16	16
4.			13	16	16	46
1. SMP-SC, 3-body			26	46	89	148
2.			26	52	95	171
1. SMP-BC		10	10	13	10	20
2.		10	20	36	26	59
3.		10	16	23	23	36
4.		23	36	43	49	105
5.		20	33	43	46	102
6.		30	39	112	82	331
7.		20	39	112	75	331
1. SMP-BCA		7	10	13	10	20
2.		16	33	59	95	276
3.		10	30	52	95	266
4.		20	59	98	135	341
5.		16	39	66	89	246
6.		16	46	135	135	499
7.		20	46	112	125	479
1. SMP-TO				16		20
2.				26		75
3.				16		79
Tubes and fittings						
Bend 90 deg.	1	3	3	3	3	7
Bend 45 deg.	1	1	3	3	3	3
Tee (out through side port)	3	7	10	13	16	23
Tee (in through side port)	3	7	7	10	13	16

* Pressure drop/equivalent tube length is for unbalanced upper plug and balanced lower plug.
For other combinations use the CAS Unique configuration tool.

Table 14.7.2a

14.7.3 DIN Tube Metric

























Equipment for DIN tube (for water at 2 m/s)	Equivalent tube length in metres per unit							
	DN25	DN40	DN50	DN65	DN80	DN100	DN125	DN150
Seat valves								
1. SRC, SMO 		8	7	15	28	33	18	44
2. 		6	6	9	21	23	22	72
3. 		4	11	18	27	33	29	72
4. 		4	6	12	23	28	27	69
5. 		6	18	44	54	57	49	150
6. 		6	15	34	36	43	38	89
1. SRC-LS								
			9	19	21	9		
2. 			4	10	14	7		
3. 			9	13	18	17		
4. 			8	7	12	13		
5. 			11	19	24	22		
6. 			10	16	22	18		
Aseptic seat valves								
1. ARC, AMO 		8	15	42	64	64		
2. 		6	11	28	44	40		
3. 		5	13	26	46	57		
4. 		5	9	22	44	43		
5. 		7	20	54	98	94		
6. 		6	17	40	77	84		
1. ARC-SB								
		10	21	34				
2. 		10	21	34				
3. 		6	11	24				
4. 		9	21	64				
Other valves								
Non-return valve LKC-2		14	14	15	32	36	30	
Butterfly valve LKB		2	1	1	2	2	2	1
1. Koltek MH 		2	2	5	9	10	8	
2. 		2	2	5	9	14	13	



























Equipment for DIN tube (for water at 2 m/s)	Equivalent tube length in metres per unit							
	DN25	DN40	DN50	DN65	DN80	DN100	DN125	DN150
Mixproof valves								
1. <i>Unique</i> *		14	14	27	25	26		
2.		14	14	27	25	26		
3.		5	4	6	5	4		
4.		6	5	7	7	5		
1. SMP-SC			15	24	54	64	49	89
2.			14	22	41	50	53	133
3.			4	6	6	6	7	22
4.			4	6	6	15	7	22
1. SMP-SC, 3-body			9	22	44	54		
2.			9	25	54	64		
1. SMP-BC		3	4	5	5	7	4	8
2.		4	7	13	15	21	38	78
3.		4	6	11	12	20	31	61
4.		9	17	22	24	40		
5.		7	13	22	23	37		
6.		10	15	52	44	114		
7.		9	15	52	44	114		
1. SMP-BCA		3	4	5	5	6		
2.		6	13	32	51	97		
3.		3	12	25	49	94		
4.		9	24	46	72	124		
5.		6	15	30	46	84		
6.		8	20	62	67	174		
7.		9	21	54	64	167		
1. SMP-TO				7		8		
2.				11		28		
3.				8		30		
Tubes and fittings								
Bend 90 deg.	0.3	1	1	1	1	2		
Bend 45 deg.	0.2	0.4	1	1	1	1		
Tee (out through side port)	1	2	3	4	5	7		
Tee (in through side port)	1	2	2	3	4	5		

* Pressure drop/equivalent tube length is for unbalanced upper plug and balanced lower plug.
For other combinations use the CAS *Unique* configuration tool.

Table 14.7.3a

14.7.4 DIN Tube Feet

Equipment for DIN tube (for water at 6 ft/s)	Equivalent tube length in feet per unit							
	1 in	1.5 in	2 in	2.5 in	3 in	4 in	5 in	6 in
Seat valves								
1. SRC, SMO 		26	23	49	92	108	59	144
2. 		20	20	30	69	75	72	236
3. 		13	36	59	89	108	95	236
4. 		13	20	39	75	92	89	226
5. 		20	59	144	177	187	161	492
6. 		20	49	112	118	141	125	292
1. SRC-LS								
			30	62	69	30		
2. 			13	33	46	23		
3. 			30	43	59	56		
4. 			26	23	39	43		
5. 			36	62	79	72		
6. 			33	52	72	59		
Aseptic seat valves								
1. ARC, AMO 		26	49	138	210	210		
2. 		20	36	92	144	131		
3. 		16	43	85	151	187		
4. 		16	30	72	144	141		
5. 		30	66	177	322	308		
6. 		20	56	131	253	276		
1. ARC-SB								
		33	69	112				
2. 		33	69	112				
3. 		20	36	79				
4. 		30	69	210				
Other valves								
Non-return valve LKC-2		46	46	49	105	118	98	
Butterfly valve LKB		7	3	3	7	7	7	3
1. Koltek MH 		7	7	16	30	33	26	
2. 		7	7	16	30	46	43	

Equipment for DIN tube (for water at 6 ft/s)		Equivalent tube length in feet per unit							
		1 in	1.5 in	2 in	2.5 in	3 in	4 in	5 in	6 in
Mixproof valves									
1. Unique *			46	46	89	82	85		
2.			46	46	89	82	85		
3.			16	13	20	16	13		
4.			20	16	23	23	16		
1. SMP-SC				49	79	177	210	161	292
2.				46	72	135	164	174	436
3.				13	20	20	20	23	72
4.				13	20	20	49	23	72
1. SMP-SC, 3-body				30	72	144	177		
2.				30	82	177	210		
1. SMP-BC			10	13	16	16	23	13	26
2.			13	23	43	49	69	125	256
3.			13	20	36	39	66	102	200
4.			30	56	72	79	131		
5.			23	43	72	75	121		
6.			33	49	171	144	374		
7.			30	49	171	144	374		
1. SMP-BCA			10	13	16	16	20		
2.			20	43	105	167	318		
3.			10	39	82	161	308		
4.			30	79	151	236	407		
5.			20	49	98	151	276		
6.			26	66	203	220	571		
7.			30	69	177	210	548		
1. SMP-TO					23		26		
2.					36		92		
3.					26		98		
Tubes and fittings									
Bend 90 deg.		1	3	3	3	3	7		
Bend 45 deg.		1	1	3	3	3	3		
Tee (out through side port)		3	7	10	13	16	23		
Tee (in through side port)		3	7	7	10	13	16		

* Pressure drop/equivalent tube length is for unbalanced upper plug and balanced lower plug.
For other combinations use the CAS Unique configuration tool.

Table 14.7.4a

14.8 Moody Diagram

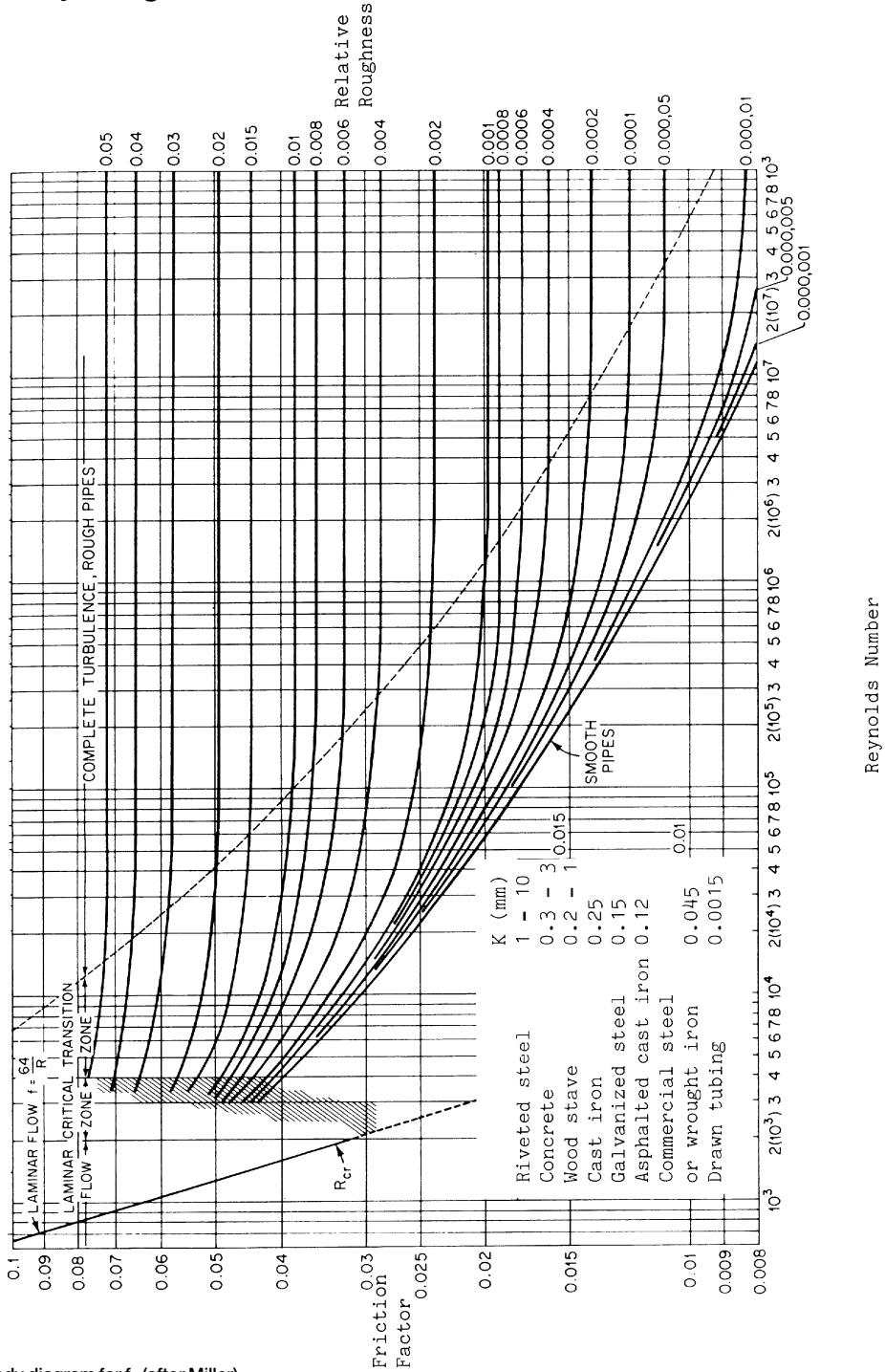

Fig. 14.8a Moody diagram for f_p (after Miller)

14.9 Initial Suction Line Sizing

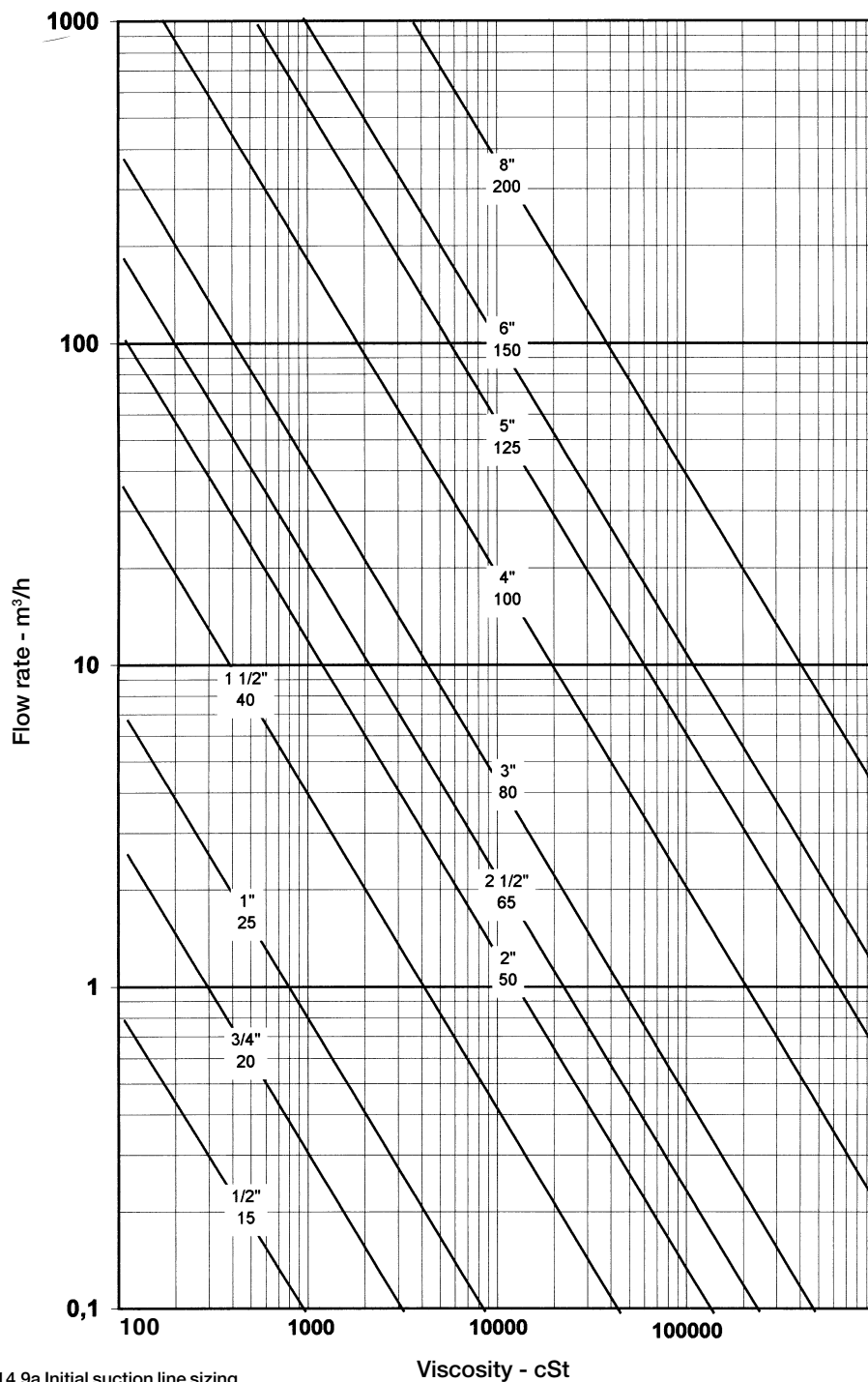

Fig. 14.9a Initial suction line sizing

14.10 Elastomer Compatibility Guide

Listed below are fluids commonly pumped.

The elastomer compatibility is for guidance purposes only as this may be affected by temperature.

The fluid viscous behaviour type shown relates to general terms - in some instances Pseudoplastic fluids can have Thixotropic tendencies.

(†) - Fluid can become Dilatant at high concentration and high shear rate.

(‡) - If low concentration, this can be Newtonian.

Name of Fluid Pumped	Elastomer Material				Viscous Behaviour Type
	NBR	EPDM	FPM	PTFE	
ACETIC ACID		✓		✓	Newtonian
ACETONE		✓		✓	Newtonian
ADHESIVE - SOLVENT BASED				✓	Pseudoplastic
ADHESIVE - WATER BASED		✓		✓	Pseudoplastic
ALUM SLUDGE	✓	✓	✓	✓	Pseudoplastic
AMMONIUM HYDROXIDE		✓		✓	Newtonian
ANIMAL FAT			✓	✓	Newtonian
BABY BATH			✓	✓	Pseudoplastic
BABY LOTION			✓	✓	Pseudoplastic
BABY OIL			✓	✓	Newtonian
BATH FOAM			✓	✓	Pseudoplastic
BATTER		✓	✓	✓	Pseudoplastic
BEER		✓	✓	✓	Newtonian
BENTONITE SUSPENSION	✓	✓	✓	✓	Pseudoplastic (†)
BISCUIT CREAM			✓	✓	Pseudoplastic
BISULPHITE	✓	✓	✓	✓	Newtonian
BITUMEN	✓		✓	✓	Pseudoplastic
BLACK LIQUOR			✓	✓	Newtonian
BLEACH		✓	✓	✓	Newtonian
BLOOD		✓	✓	✓	Newtonian
BODY LOTION			✓	✓	Pseudoplastic
BODY SCRUB			✓	✓	Pseudoplastic
BRINE	✓	✓	✓	✓	Newtonian
BUTTER		✓	✓	✓	Pseudoplastic
CALCIUM CARBONATE SLURRY	✓	✓	✓	✓	Pseudoplastic
CARAMEL - COLOURING		✓	✓	✓	Newtonian
CARAMEL - TOFFEE		✓	✓	✓	Pseudoplastic
CASTOR OIL	✓		✓	✓	Newtonian
CELLULOSE ACETATE DOPE				✓	Pseudoplastic
CELLULOSE SUSPENSION	✓	✓	✓	✓	Pseudoplastic
CERAMIC SLIP	✓	✓	✓	✓	Pseudoplastic (†)

Name of Fluid Pumped	Elastomer Material				Viscous Behaviour Type
	NBR	EPDM	FPM	PTFE	
CHEESE		✓	✓	✓	Pseudoplastic
CHEWING GUM				✓	Pseudoplastic
CHINA CLAY SLURRY	✓	✓	✓	✓	Pseudoplastic (t)
CHOCOLATE			✓	✓	Pseudoplastic
CHROMIC ACID			✓	✓	Newtonian
CHUTNEY		✓	✓	✓	Pseudoplastic
CITRIC ACID	✓	✓	✓	✓	Newtonian
COAL TAR			✓	✓	Newtonian
COCOA BUTTER			✓	✓	Newtonian
COCOA LIQUOR			✓	✓	Pseudoplastic
COCONUT CREAM			✓	✓	Pseudoplastic
COLLAGEN GEL		✓	✓	✓	Pseudoplastic
CONDENSED MILK		✓	✓	✓	Pseudoplastic
COPPER SULPHATE		✓	✓	✓	Newtonian
CORN STEEP LIQUOR		✓	✓	✓	Newtonian
CORN SYRUP	✓	✓	✓	✓	Newtonian
COSMETIC CREAM			✓	✓	Pseudoplastic
COUGH SYRUP		✓	✓	✓	Pseudoplastic
CRUDE OIL			✓	✓	Pseudoplastic
CUSTARD		✓	✓	✓	Pseudoplastic
DAIRY CREAM		✓	✓	✓	Pseudoplastic
DETERGENT - AMPHOTERIC			✓	✓	Newtonian
DETERGENT - ANIONIC	✓	✓	✓	✓	Pseudoplastic (t)
DETERGENT - CATIONIC			✓	✓	Newtonian
DETERGENT - NONIONIC		✓	✓	✓	Newtonian
DIESEL OIL	✓		✓	✓	Newtonian
DODECYL BENZENE SULPHONIC ACID			✓	✓	Newtonian
DRILLING MUD	✓	✓	✓	✓	Pseudoplastic
DYE		✓	✓	✓	Newtonian
EGG		✓	✓	✓	Pseudoplastic
ENZYME SOLUTION		✓		✓	Newtonian
ETHANOL	✓	✓		✓	Newtonian
ETHYLENE GLYCOL	✓	✓	✓	✓	Newtonian
FABRIC CONDITIONER			✓	✓	Pseudoplastic
FATS			✓	✓	Newtonian
FATTY ACID			✓	✓	Newtonian
FERRIC CHLORIDE	✓	✓	✓	✓	Newtonian
FERTILISER	✓	✓	✓	✓	Pseudoplastic
FILTER AID	✓	✓	✓	✓	Pseudoplastic
FININGS		✓	✓	✓	Pseudoplastic
FIRE FIGHTING FOAM			✓	✓	Pseudoplastic
FISH OIL			✓	✓	Newtonian
FONDANT		✓	✓	✓	Pseudoplastic
FORMIC ACID		✓		✓	Newtonian
FROMAGE FRAIS		✓	✓	✓	Pseudoplastic
FRUCTOSE		✓	✓	✓	Newtonian
FRUIT JUICE CONCENTRATE		✓	✓	✓	Pseudoplastic
FRUIT PUREE		✓	✓	✓	Pseudoplastic

Technical Data

Name of Fluid Pumped	Elastomer Material				Viscous Behaviour Type
	NBR	EPDM	FPM	PTFE	
FUDGE		✓	✓	✓	Pseudoplastic
GELATINE		✓	✓	✓	Pseudoplastic
GLUCOSE		✓	✓	✓	Newtonian
GLYCERINE	✓	✓	✓	✓	Newtonian
GREASE	✓		✓	✓	Pseudoplastic
GYPSPUM SLURRY	✓	✓	✓	✓	Pseudoplastic
HAIR CONDITIONER			✓	✓	Pseudoplastic
HAIR GEL			✓	✓	Pseudoplastic
HAND CLEANSER			✓	✓	Pseudoplastic
HONEY		✓	✓	✓	Pseudoplastic
HYDROCHLORIC ACID			✓	✓	Newtonian
HYDROGEN PEROXIDE			✓	✓	Newtonian
ICE CREAM MIX		✓	✓	✓	Pseudoplastic
INK - PRINTING			✓	✓	Pseudoplastic
INK - WATER BASED		✓	✓	✓	Newtonian
ISOBUTYL ALCOHOL		✓	✓	✓	Newtonian
ISOCYANATE				✓	Newtonian
ISOPROPANOL		✓	✓	✓	Newtonian
JAM		✓	✓	✓	Pseudoplastic
KEROSENE	✓		✓	✓	Newtonian
LACTIC ACID			✓	✓	Newtonian
LACTOSE		✓	✓	✓	Newtonian
LANOLIN			✓	✓	Newtonian
LATEX		✓		✓	Pseudoplastic
LECITHIN			✓	✓	Newtonian
LIPSTICK			✓	✓	Pseudoplastic
LIQUORICE			✓	✓	Pseudoplastic
MAGMA		✓	✓	✓	Pseudoplastic
MAIZE STARCH SLURRY	✓	✓	✓	✓	Pseudoplastic
MALT EXTRACT		✓	✓	✓	Pseudoplastic
MANGANESE NITRATE			✓	✓	Newtonian
MASCARA			✓	✓	Pseudoplastic
MASHED POTATO		✓	✓	✓	Pseudoplastic
MASSECUITE		✓	✓	✓	Pseudoplastic
MAYONNAISE				✓	Pseudoplastic
MEAT PASTE		✓	✓	✓	Pseudoplastic
METHANOL	✓	✓		✓	Newtonian
METHYL ETHYL KETONE SOLVENT		✓		✓	Newtonian
METHYLATED SPIRIT	✓	✓		✓	Newtonian
METHYLENE CHLORIDE			✓	✓	Newtonian
MILK		✓	✓	✓	Newtonian
MINCEMEAT		✓	✓	✓	Pseudoplastic
MINERAL OIL	✓		✓	✓	Newtonian
MOLASSES		✓	✓	✓	Newtonian
MUSTARD		✓	✓	✓	Pseudoplastic
NEAT SOAP		✓		✓	Pseudoplastic
NITRIC ACID			✓	✓	Newtonian
PAINTS - SOLVENT BASED				✓	Pseudoplastic

Name of Fluid Pumped	Elastomer Material				Viscous Behaviour Type
	NBR	EPDM	FPM	PTFE	
PAINTS - WATER BASED	✓	✓	✓	✓	Pseudoplastic
PAPER COATING - CLAY		✓		✓	Pseudoplastic (†)
PAPER COATING - PIGMENT	✓	✓	✓	✓	Pseudoplastic (†)
PAPER COATING - STARCH	✓	✓	✓	✓	Pseudoplastic
PAPER PULP	✓	✓	✓	✓	Pseudoplastic
PEANUT BUTTER			✓	✓	Pseudoplastic
PERACETIC ACID				✓	Newtonian
PETFOOD		✓	✓	✓	Pseudoplastic
PETROLEUM	✓		✓	✓	Newtonian
PHOSPHORIC ACID		✓		✓	Newtonian
PHOTOGRAPHIC EMULSION		✓	✓	✓	Pseudoplastic
PLASTISOL		✓		✓	Newtonian
POLYETHYLENE GLYCOL		✓	✓	✓	Newtonian
POLYVINYL ALCOHOL		✓	✓	✓	Pseudoplastic
POTASSIUM HYDROXIDE		✓		✓	Newtonian
PROPIONIC ACID				✓	Newtonian
PROPYLENE GLYCOL	✓	✓	✓	✓	Newtonian
QUARG		✓	✓	✓	Pseudoplastic
RESIN			✓	✓	Newtonian
RUBBER SOLUTION				✓	Pseudoplastic
SAUCE - CONFECTIONERY			✓	✓	Pseudoplastic
SAUCE - VEGETABLE		✓	✓	✓	Pseudoplastic
SAUSAGE MEAT		✓	✓	✓	Pseudoplastic
SEWAGE SLUDGE	✓	✓	✓	✓	Pseudoplastic
SHAMPOO			✓	✓	Pseudoplastic
SHAVING CREAM			✓	✓	Pseudoplastic
SILICONE OIL	✓	✓	✓	✓	Newtonian
SODIUM HYDROXIDE		✓		✓	Newtonian
SODIUM SILICATE		✓	✓	✓	Newtonian
SORBIC ACID				✓	Newtonian
SORBITOL	✓	✓	✓	✓	Newtonian
STARCH		✓	✓	✓	Pseudoplastic
SUGAR PULP - BEET		✓	✓	✓	Pseudoplastic
SUGAR PULP - CANE		✓	✓	✓	Pseudoplastic
SUGAR SYRUP		✓	✓	✓	Newtonian
SULPHURIC ACID			✓	✓	Newtonian
TALL OIL			✓	✓	Newtonian
TALLOW			✓	✓	Newtonian
TITANIUM DIOXIDE	✓	✓	✓	✓	Pseudoplastic (†)
TOBACCO FLAVOURING		✓			Newtonian
TOLUENE			✓	✓	Newtonian
TOMATO KETCHUP		✓	✓	✓	Pseudoplastic
TOMATO PUREE		✓	✓	✓	Pseudoplastic
TOOTHPASTE			✓	✓	Pseudoplastic
TRUB	✓	✓	✓	✓	Pseudoplastic
UREA		✓	✓	✓	Newtonian
VARNISH				✓	Newtonian
VASELINE	✓		✓	✓	Pseudoplastic

Technical Data

Name of Fluid Pumped	Elastomer Material				Viscous Behaviour Type
	NBR	EPDM	FPM	PTFE	
VEGETABLE GUM		✓	✓	✓	Pseudoplastic
VEGETABLE OIL			✓	✓	Newtonian
VITAMIN SOLUTION		✓	✓	✓	Newtonian
WATER	✓	✓	✓	✓	Newtonian
WAX			✓	✓	Newtonian
WHEY		✓	✓	✓	Newtonian
WHITE SPIRIT			✓	✓	Newtonian
WINE		✓	✓	✓	Newtonian
WORT		✓	✓	✓	Newtonian
XYLENE			✓	✓	Newtonian
YEAST		✓	✓	✓	Pseudoplastic
YOGHURT		✓	✓	✓	Pseudoplastic
ZEOLITE SLURRY	✓	✓	✓	✓	Pseudoplastic (†)
ZIRCONIA SLURRY	✓	✓	✓	✓	Pseudoplastic (†)

Table 14.10a Elastomer compatibility guide

14.11 Changing Motor Name Plates

Manufacturer	Frame Size	Output Power kW	Frequency Hz	Supply Voltage V	Motor Nameplate	Rated Speed rev/min	Power Factor	Rated Current A	
2-pole motors									
ABB	71 C	0.55	50	220-240Δ/380-420Y	Standard	2870	0.81	2.3/1.3	
		0.55	50	200Δ	New	2810	0.89	2.4	
		0.55	60	380-480Y	Standard	3460	0.82	1.2	
		0.55	60	200Δ	New	3370	0.91	2.3	
		0.55	60	220Δ	New	3420	0.88	2.1	
ABB	80 A	0.75	50	220-240Δ/380-420Y	Standard	2860	0.82	3.1/1.8	
		0.75	50	200Δ	New	2810	0.89	3.3	
		0.75	60	440-480Y	Standard	3490	0.78	1.5	
		0.75	60	200Δ	New	3380	0.90	3.1	
		0.75	60	220Δ	New	3430	0.88	2.8	
		0.75	60	400Y	New	3450	0.86	1.6	
		0.75	60	380Y	New	3420	0.88	1.6	
ABB	80 C	1.1	50	220-240Δ/380-420Y	Standard	2870	0.85	4.3/2.5	
		1.1	50	200Δ	New	2840	0.90	4.5	
		1.1	60	440-480Y	Standard	3500	0.83	2.0	
		1.1	60	200Δ	New	3400	0.91	4.3	
		1.1	60	220Δ	New	3450	0.90	3.9	
		1.1	60	400Y	New	3460	0.89	2.2	
		1.1	60	380Y	New	3450	0.90	2.3	
ABB	90 L	1.5	50	220-240Δ/380-420Y	Standard	2920	0.85	5.4/3.2	
		1.5	50	200Δ	New	2880	0.89	6.0	
		1.75	60	440-480Y	Standard	3510	0.85	3.1	
		1.5	60	200Δ	New	3460	0.91	5.9	
		1.6	60	220Δ	New	3490	0.89	5.4	
		1.6	60	400Y	New	3500	0.88	3.0	
		1.6	60	380Y	New	3490	0.89	3.1	
ABB	90 LB	2.2	50	220-240Δ/380-420Y	Standard	2900	0.85	8.1/4.7	
		2.2	50	200Δ	New	2860	0.90	8.7	
		2.5	60	440-480Y	Standard	3500	0.86	4.4	
		2.1	60	200Δ	New	3430	0.91	8.3	
		2.3	60	220Δ	New	3470	0.90	7.5	
		2.3	60	400Y	New	3470	0.90	4.5	
		2.3	60	380Y	New	3450	0.91	4.8	
ABB	100 LB	3.0	50	220-240Δ/380-420Y	Standard	2920	0.88	9.9/5.7	
		3.0	50	200Δ	New	2890	0.91	11.0	
		3.5	60	440-480Y	Standard	3520	0.88	5.7	
		3.0	60	200Δ	New	3470	0.92	10.9	
		3.2	60	220Δ	New	3490	0.91	10.5	
		3.2	60	400Y	New	3500	0.91	5.8	
		3.2	60	380Y	New	3490	0.91	6.1	
		3.0	50	380-420Δ/660-690Y	Standard	2920	0.87	5.7/3.3	
		3.5	60	440-480Δ	Standard	3520	0.88	5.7	
		3.2	60	400Δ	New	3500	0.91	5.8	
		3.2	60	380Δ	New	3490	0.91	6.1	

Technical Data

Manufacturer	Frame Size	Output Power kW	Frequency Hz	Supply Voltage V	Motor Nameplate	Rated Speed rev/min	Power Factor	Rated Current A		
2-pole motors										
ABB	112 M	4.0	50	220-240Δ/380-420Y	Standard	2850	0.91	13.5/7.8		
		3.7	50	200Δ	New	2790	0.92	14.5		
		4.6	60	440-480Y	Standard	3450	0.91	7.7		
		3.4	60	200Δ	New	3360	0.92	13.1		
		3.8	60	220Δ	New	3390	0.91	13.3		
		4.0	60	400Y	New	3400	0.91	7.4		
		3.8	60	380Y	New	3390	0.91	7.7		
		4.0	50	380-420Δ/660-690Y	Standard	2850	0.91	7.8/4.5		
		4.6	60	440-480Δ	Standard	3450	0.91	7.7		
		4.0	60	400Δ	New	3400	0.91	7.4		
		3.8	60	380Δ	New	3390	0.91	7.7		
		ABB	132 SA	5.5	50	220-240Δ/380-420Y	Standard	2855	0.88	18.9/10.9
				5.4	50	200Δ	New	2790	0.90	21.0
6.4	60			440-480Y	Standard	3455	0.88	10.9		
5.4	60			200Δ	New	3345	0.91	21.0		
5.4	60			220Δ	New	3395	0.89	18.8		
5.7	60			400Y	New	3380	0.89	10.9		
5.4	60			380Y	New	3370	0.89	10.9		
5.5	50			380-420Δ/660-690Y	Standard	2855	0.88	10.9/6.3		
6.4	60			440-480Δ	Standard	3455	0.88	10.9		
5.7	60			400Δ	New	3380	0.89	10.9		
5.4	60			380Δ	New	3370	0.89	10.9		
ABB	132 SB			7.5	50	220-240Δ/380-420Y	Standard	2855	0.90	25.5/14.7
				6.6	50	200Δ	New	2825	0.91	25.0
		8.6	60	440-480Y	Standard	3455	0.90	14.4		
		7.0	60	200Δ	New	3365	0.92	26.0		
		7.4	60	220Δ	New	3405	0.91	25.0		
		7.8	60	400Y	New	3415	0.91	14.4		
		7.4	60	380Y	New	3405	0.91	14.4		
		7.5	50	380-420Δ/660-690Y	Standard	2855	0.90	14.7/8.5		
		8.6	60	440-480Δ	Standard	3455	0.90	14.4		
		7.8	60	400Δ	New	3415	0.91	14.4		
		7.4	60	380Δ	New	3405	0.91	14.4		
		ABB	160 MA	11.0	50	230Δ/400Y	Standard	2930	0.88	34.5/20.0
				11.0	50	200Δ	New	2900	0.89	40.0
12.5	60			440Y	Standard	3515	0.89	20.0		
11.0	60			200Δ	New	3475	0.89	40.0		
12.2	60			220Δ	New	3485	0.89	40.0		
12.5	60			400Y	New	3500	0.89	22.0		
12.2	60			380Y	New	3485	0.89	23.0		
11.0	50			400Δ/690Y	Standard	2930	0.88	20.0/11.5		
12.5	60			440Δ	Standard	3515	0.89	20.0		
12.5	60			400Δ	New	3500	0.89	22.0		
12.2	60			380Δ	New	3485	0.89	23.0		

Manufacturer	Frame Size	Output Power kW	Frequency Hz	Supply Voltage V	Motor Nameplate	Rated Speed rev/min	Power Factor	Rated Current A		
2-pole motors										
ABB	160M	15.0	50	230Δ/400Y	Standard	2920	0.9	46.0/26.5		
		14.5	50	200Δ	New	2890	0.9	53.0		
		17.0	60	440Y	Standard	3505	0.9	27.5		
		14.0	60	200Δ	New	3470	0.9	51.0		
		15.7	60	220Δ	New	3485	0.89	52.0		
		16.5	60	400Y	New	3500	0.89	30.0		
		15.7	60	380Y	New	3485	0.89	30.0		
		15.0	50	400Δ/690Y	Standard	2920	0.9	26.5/15.3		
		17.0	60	440Δ	Standard	3505	0.9	27.5		
		16.5	60	400Δ	New	3500	0.89	30.0		
		15.7	60	380Δ	New	3485	0.89	30.0		
		ABB	160 L	18.5	50	230Δ/400Y	Standard	2920	0.91	55.0/32.0
				17.2	50	200Δ	New	2895	0.91	60.0
21.0	60			440Y	Standard	3510	0.91	33.5		
16.7	60			200Δ	New	3500	0.91	59.0		
18.5	60			220Δ	New	3490	0.91	59.0		
19.4	60			400Y	New	3500	0.91	34.0		
18.5	60			380Y	New	3490	0.91	34.0		
18.5	50			400Δ/690Y	Standard	2920	0.91	32.0/18.5		
21.0	60			440Δ	Standard	3510	0.91	33.5		
19.4	60			400Δ	New	3500	0.91	34.0		
18.5	60			380Δ	New	3490	0.91	34.0		
ABB	180 M			22.0	50	230Δ/400Y	Standard	2930	0.89	67.0/38.5
				22.0	50	200Δ	New	2920	0.90	77.0
		25.0	60	440Y	Standard	3530	0.90	40.5		
		22.0	60	200Δ	New	3505	0.91	76.0		
		25.0	60	220Δ	New	3510	0.89	80.0		
		25.0	60	400Y	New	3520	0.88	44.0		
		25.0	60	380Y	New	3510	0.89	46.0		
		22.0	50	400Δ/690Y	Standard	2930	0.89	38.5/22.0		
		25.0	60	440Δ	Standard	3530	0.90	40.5		
		25.0	60	400Δ	New	3520	0.88	44.0		
		25.0	60	380Δ	New	3510	0.89	46.0		
		4-pole motors								
		ABB	90 L-4	1.5	50	220-240Δ/380-420Y	Standard	1440	0.74	6.2/3.6
1.5	50			200Δ	New	1380	0.86	6.3		
1.75	60			440-480Y	Standard	1730	0.76	3.5		
1.5	60			200Δ	New	1660	0.87	6.2		
1.6	60			220Δ	New	1680	0.86	6.1		
1.75	60			400Y	New	1680	0.86	3.6		
1.75	60			380Y	New	1660	0.87	3.8		

Technical Data

Manufacturer	Frame Size	Output Power kW	Frequency Hz	Supply Voltage V	Motor Nameplate	Rated Speed rev/min	Power Factor	Rated Current A		
4-pole motors										
ABB	132 S-4	5.5	50	220-240Δ/380-420Y	Standard	1440	0.83	19.9/11.5		
		5.3	50	200Δ	New	1430	0.86	21.1		
		6.4	60	440-480Y	Standard	1750	0.83	11.5		
		5.5	60	200Δ	New	1700	0.86	22.0		
		6.0	60	220Δ	New	1730	0.86	21.5		
		6.3	60	400Y	New	1735	0.86	12.4		
		6.0	60	380Y	New	1730	0.86	12.4		
		5.5	50	380-420Δ/660-690Y	Standard	1450	0.83	11.5/6.6		
		6.4	60	440-480Δ	Standard	1750	0.83	11.5		
		6.3	60	400Δ	New	1735	0.86	12.4		
		6.0	60	380Δ	New	1730	0.86	12.4		
		ABB	132 M-4	7.5	50	220-240Δ/380-420Y	Standard	1450	0.83	27.0/15.3
				6.8	50	200Δ	New	1440	0.86	26.3
8.6	60			440-480Y	Standard	1750	0.83	15.1		
7.4	60			200Δ	New	1720	0.87	29.0		
8.0	60			220Δ	New	1730	0.87	28.0		
8.4	60			400Y	New	1735	0.87	16.2		
8.0	60			380Y	New	1730	0.87	16.2		
7.5	50			380-420Δ/660-690Y	Standard	1450	0.83	15.3/8.8		
8.6	60			440-480Δ	Standard	1750	0.83	15.1		
8.4	60			400Δ	New	1735	0.87	16.2		
8.0	60			380Δ	New	1730	0.87	16.2		
ABB	160 L-4			15.0	50	230Δ/400Y	Standard	1455	0.84	49.0/28.5
				14.0	50	200Δ	New	1440	0.86	53.0
		17.0	60	440Y	Standard	1745	0.84	30.0		
		14.0	60	200Δ	New	1720	0.85	54.0		
		16.0	60	220Δ	New	1730	0.85	55.0		
		16.8	60	400Y	New	1735	0.85	32.0		
		16.0	60	380Y	New	1730	0.85	32.0		
		15.0	50	400Δ/690Y	Standard	1455	0.84	28.5/16.5		
		17.0	60	440Δ	Standard	1765	0.84	30.0		
		16.8	60	400Δ	New	1735	0.85	32.0		
		16.0	60	380Δ	New	1730	0.85	32.0		
		ABB	180M-4	18.5	50	230Δ/400Y	Standard	1470	0.84	61.0/35.0
				18.5	50	200Δ	New	1460	0.85	70.0
21.0	60			440Y	Standard	1765	0.85	36.0		
18.5	60			200Δ	New	1750	0.84	71.0		
20.5	60			220Δ	New	1755	0.85	70.0		
21.0	60			400Y	New	1755	0.85	41.0		
20.5	60			380Y	New	1755	0.85	40.0		
18.5	50			400Δ/690Y	Standard	1470	0.84	35.0/20.0		
21.0	60			440Δ	Standard	1765	0.85	36.0		
21.0	60			400Δ	New	1755	0.85	41.0		
20.5	60			380Δ	New	1755	0.85	40.0		

Manufacturer	Frame Size	Output Power kW	Frequency Hz	Supply Voltage V	Motor Nameplate	Rated Speed rev/min	Power Factor	Rated Current A
2-pole motors								
Brook Hansen	200	30.0	50	220-240Δ/380-420Y	Standard	2950	0.89	97/53
			50	200Δ	New	2950		106
	30.0	50	50	380-420Δ/660-690Y	Standard	2950		53/31
			60	250-280Δ/440-480Y	Standard	3540		83/46
			60	200Δ	New	3540		107
			60	220Δ	New	3540		97
			60	440-480Δ	Standard	3540		46
			60	400Δ	New	3540		53
60	380Δ	New	3540	55				
Brook Hansen	200	37.0	50	220-240Δ/380-420Y	Standard	2940	0.89	118/68
			50	200Δ	New	2940		130
	37.0	50	50	380-420Δ/660-690Y	Standard	2940		68/38
			60	250-280Δ/440-480Y	Standard	3540		115/54
			60	200Δ	New	3540		131
			60	220Δ	New	3540		119
			60	440-480Δ	Standard	3540		54
			60	400Δ	New	3540		65
60	380Δ	New	3540	69				
Brook Hansen	200	45.0	50	220-240Δ/380-420Y	Standard	2955	0.90	143/79
			50	200Δ	New	2955		157
	45.0	50	50	380-420Δ/660-690Y	Standard	2955		83/46
			60	250-280Δ/440-480Y	Standard	3555		144/69
			60	200Δ	New	3555		158
			60	220Δ	New	3555		144
			60	440-480Δ	Standard	3555		69
			60	400Δ	New	3555		72
60	380Δ	New	3555	75				
Brook Hansen	250	55.0	50	220-240Δ/380-420Y	Standard	2960	0.90	172/95
			50	200Δ	New	2960		189
	55.0	50	50	380-420Δ/660-690Y	Standard	2960		100/55
			60	250-280Δ/440-480Y	Standard	3560		173/83
			60	200Δ	New	3560		190
			60	220Δ	New	3560		173
			60	440-480Δ	Standard	3560		83
			60	400Δ	New	3560		100
60	380Δ	New	3560	105				
Brook Hansen	250	75.0	50	220-240Δ/380-420Y	Standard	2965	0.90	232/128
			50	200Δ	New	2965		256
	75.0	50	50	380-420Δ/660-690Y	Standard	2965		135/74
			60	250-280Δ/440-480Y	Standard	3565		234/115
			60	200Δ	New	3565		257
			60	220Δ	New	3565		234
			60	440-480Δ	Standard	3565		115
			60	400Δ	New	3565		128
60	380Δ	New	3565	135				

Table 14.11a Changing motor name plates

15. Glossary of Terms

This section explains the various terms found in this handbook.

Absolute Pressure	Total pressure exerted by a fluid i.e. atmospheric pressure plus gauge pressure.
Absolute Viscosity	Measure of how resistive the flow of a fluid is between two layers of fluid in motion.
Adaptor	Connection piece between the motor and back plate on a centrifugal and liquid ring pump.
Anti-thixotropic	Fluid viscosity increases with time under shear conditions.
Back Plate	Part of a centrifugal and liquid ring pump, which together with the pump casing forms the fluid chamber.
Cavitation	Vacuous space in the inlet port of a pump normally occupied by fluid.
Centrifugal	Tending to move out from the centre.
CIP	Cleaning In Place - ability to clean pump system without dismantling pump and system.
Dead Head Speed	Pump speed required to overcome slip for a rotary lobe pump.
Density	Fluids mass per unit of volume.
Differential Pressure	Total absolute pressure differences across the pump during operation i.e. discharge pressure minus suction pressure.
Dilatant	Fluid viscosity increases as shear rate increases.
Discharge Pressure	Pressure at which fluid is leaving the pump.

Duty Point	Intersection point between the pump curve and the process curve.
Dynamic Head	Energy required to set fluid in motion and to overcome any resistance to that motion.
Elastomer	Non-metallic sealing device that exhibits elastic strain characteristics.
Electropolishing	Method of surface finishing achieved by an electro-chemical process.
Flooded Suction	Positive inlet pressure/head.
Friction Head	Pressure drop on both inlet and discharge sides of the pump due to frictional losses in fluid flow.
Gauge Pressure	Pressure within a gauge that exceeds the surrounding atmospheric pressure, using atmospheric pressure as a zero reference.
Hydraulic Power	Theoretical energy required to pump a given quantity of fluid against a given total head.
Impeller	Pumping element of a centrifugal and liquid ring pump.
Inlet Pressure	Pressure at which fluid is entering the pump.
Kinematic Viscosity	Measure of how resistive the flow of a fluid is under the influence of gravity.
Laminar Flow	Flow characteristic whereby the fluid moves through the pipe in concentric layers with its maximum velocity in the centre of the pipe, decreasing to zero at the pipe wall.
Multi-stage	A pump with more than one impeller mounted on the same shaft and connected so as to act in series.
Newtonian	Fluid viscosity is constant with change in shear rate or agitation.
NPSH	Net Positive Suction Head describing the inlet condition of a pump and system.
NPSHa	Net Positive Suction Head available in a system.
NPSHr	Net Positive Suction Head required from a pump.
NIPA	Net Inlet Pressure Available in a system.
NIPR	Net Inlet Pressure Required from a pump.

Non-Product Wetted	Metallic and elastomeric components not in contact with the fluid being pumped.
Outlet Pressure	Pressure at which fluid is leaving the pump.
Positive Displacement	Pump type whereby the fluid pumped is directly displaced.
Pressure Drop	Result of frictional losses in pipework, fittings and other process equipment.
Pressure Shock	Result of change in fluid velocity.
Product Wetted	Metallic and elastomeric components in contact with the fluid being pumped.
Pseudoplastic	Fluid viscosity decreases as shear rate increases.
Pump Casing	Part of a centrifugal and liquid ring pump, which together with the back plate forms the fluid chamber.
Required Power	Power needed at the pump shaft.
Reynolds Number (Re)	Ratio of inertia forces to viscous forces giving a value to determine type of flow characteristic.
Rheology	Science of fluid flow.
Rheomalactic	Fluid viscosity decreases with time under shear conditions but does not recover.
Rotodynamic	A machine to transfer rotating mechanical energy into kinetic energy in the form of fluid velocity and pressure.
Rotor	Pumping element of a rotary lobe pump.
Rotorcase	Part of a rotary lobe pump, which together with the rotorcase cover forms the pump chamber.
Rotorcase Cover	Part of a rotary lobe pump, which together with the rotorcase forms the pump chamber.
Rumbling	Method of surface finishing achieved by vibrating components with abrasive particulate.
Shotblasting	Method of surface finishing achieved by blasting finished components with small metallic particles at great force.

SIP	Steam or Sterilisation In Place - ability to steam clean or sterilise pump system without dismantling pump and system.
Slip	Fluid lost by leakage through the pump clearances of a rotary lobe pump.
Specific Gravity	Ratio of a fluids density to the density of water.
Specific Weight	Fluids weight per unit volume.
Static Head	Difference in fluid levels.
Static Discharge Head	Difference in height between the fluid level and the centre line of the pump inlet on the discharge side of the pump.
Static Suction Head	Difference in height between the fluid level and the centre line of the pump inlet on the inlet side of the pump.
Suction Lift	Fluid level is below the centre line of the pump inlet.
Suction Pressure	Pressure at which fluid is entering the pump.
Thermal Shock	Rapid temperature change of pumphead components.
Thixotropic	Fluid viscosity decreases with time under shear conditions.
Torque	Moment of force required to produce rotation.
Total Discharge Head	Sum of the static discharge and dynamic heads.
Total Efficiency	Relationship between the input power at the pump shaft and output power in the form of water horsepower.
Total Head	Total pressure difference between the total discharge head and the total suction head of the pump.
Total Static Head	Difference in height between the static discharge head and the static suction head.
Total Suction Head	Static suction head less the dynamic head.
Transitional Flow	Flow characteristic combining both laminar and turbulent flow tendencies.
Turbulent Flow	Flow characteristic whereby considerable mixing of the fluid takes place across a pipe section with velocity remaining fairly constant.

Vacuum	Pressure in a pumping system below normal atmospheric pressure.
Vapour Pressure	Pressure at which a fluid will change to a vapour, at a given temperature.
Velocity	Distance a fluid moves per unit of time.
Viscosity	Measure of how resistive a fluid is to flow.
Viscous Power	Power loss due to viscous fluid friction within the pump.
Volumetric Efficiency	Ratio of actual capacity against theoretical capacity.

Alfa Laval in brief

Alfa Laval is a leading global provider of specialized products and engineering solutions.

Our equipment, systems and services are dedicated to assisting customers in optimizing the performance of their processes. Time and time again.

We help them heat, cool, separate and transport products such as oil, water, chemicals, beverages, foodstuff, starch and pharmaceuticals.

Our worldwide organization works closely with customers in almost 100 countries to help them stay ahead.

How to contact Alfa Laval

Contact details for all countries are continually updated on our website. Please visit www.alfalaval.com to access the information.

