



MUNSCH
Plastic Pumps for Aggressive Media

Chemical pumps

With mechanical seal

**Non-metallic standardized chemical pump
Type NP**

In PP / PE-UHMW / PVDF
Dimensions to EN 22858 / ISO 2858



Standardized chemical pump NP

► Applications

Type NP standardized chemical pumps are the solution of choice whenever it comes to pumping acids, alkalis or chemically contaminated fluids in the presence or absence of solids. Typical applications include the chemical and metal finishing industries, steel and stainless steel pickling lines, evaporation and regeneration units, flue gas scrubbing downstream of waste incinerators as well as exhaust air cleaning and scrubber effluent treatment.

► Construction

Horizontal centrifugal pump with volute casing and single-entry, single-stage radial impeller, nominal pressure PN 10. Casing and fitting dimensions to EN 22858/ISO 2858, complemented by size 40-25-160 and 250-200-400 pumps.

► Materials

Part designation	Standard material range		
	PP	PE-UHMW	PVDF
Pump casing	PP	PE-UHMW	PVDF
Intermediate lantern	EN-JL 1030 (GG 20)		
Suction flange	EN-JL 1030 (GG 20)		
Discharge flange	1.0037		
Casing cover	PP ¹⁾	PE-UHMW ¹⁾	PVDF ¹⁾
Pump shaft	Tempering steel		
Impeller	PP ¹⁾	PE-UHMW ¹⁾	PVDF ¹⁾
Bearing bracket	EN-JL 1030 (GG 20)		
Secondary seals	EPDM, FPM, FFKM		
Rotating seal ring	SSiC		
Stationary seal ring	SSiC		
Shaft sleeve	1.4571 / Fluoroplastics		

1) Material combinations possible

PP	Polypropylene
PE-UHMW	ultrahigh-molecular polyethylene
PVDF	Polyvinylidene fluoride
SSiC	High-purity silicon carbide
FPM	Fluoroelastomer
EPDM	Ethylene propylene diene elastomer
FFKM	Perfluoro elastomer

► Maximum allowable service pressures and temperatures

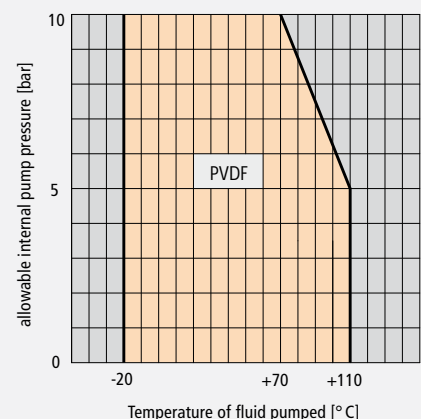
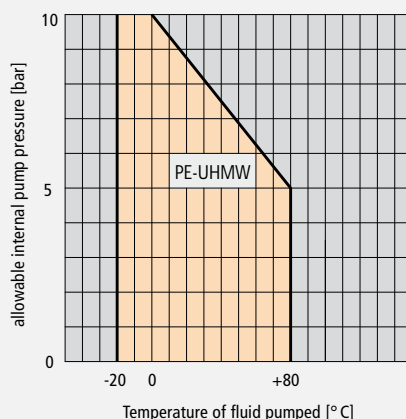
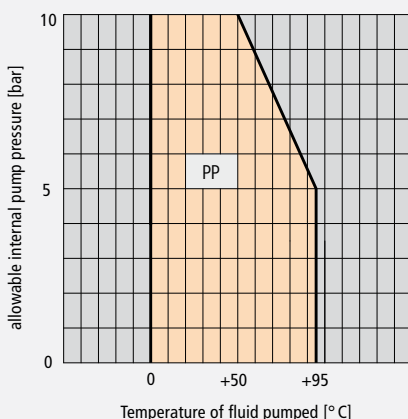

The above maximum allowable service pressures and temperatures relate to the standard pump design. Higher pressure and temperature applications possible in consultation with MUNSCH GmbH.

► Performance data for 50/60 Hz operation²⁾

Pump capacity [Q] up to	1200 m ³ /h
Total differential head [H] up to	100 m
Diameter of discharge nozzle	DN 25 up to DN 250
Motor rating [P] up to	200 kW

2) Performance data for standardized pumps; extended performance ranges on request

► Shaft seal

Single or double mechanical seal

► Flange connection

Standard design to DIN 2501, PN 16, alternatively: - to ANSI B16.5, class 150, - to JIS B2210, class 10K.

► Drive

Three-phase a.c. motor, frame type B3 to IEC, BS or NEMA; type of protection, flameproof enclosure and motor voltage to customer specifications.

► Coating

Highly resistant surface coating:

- Base coat: epoxy resin
Coat thickness 60-80 micrometer
 - Top coat: polyurethane
Coat thickness 60-80 micrometer
- Total coat thickness: 130-150 micrometer

Painting and special painting on request

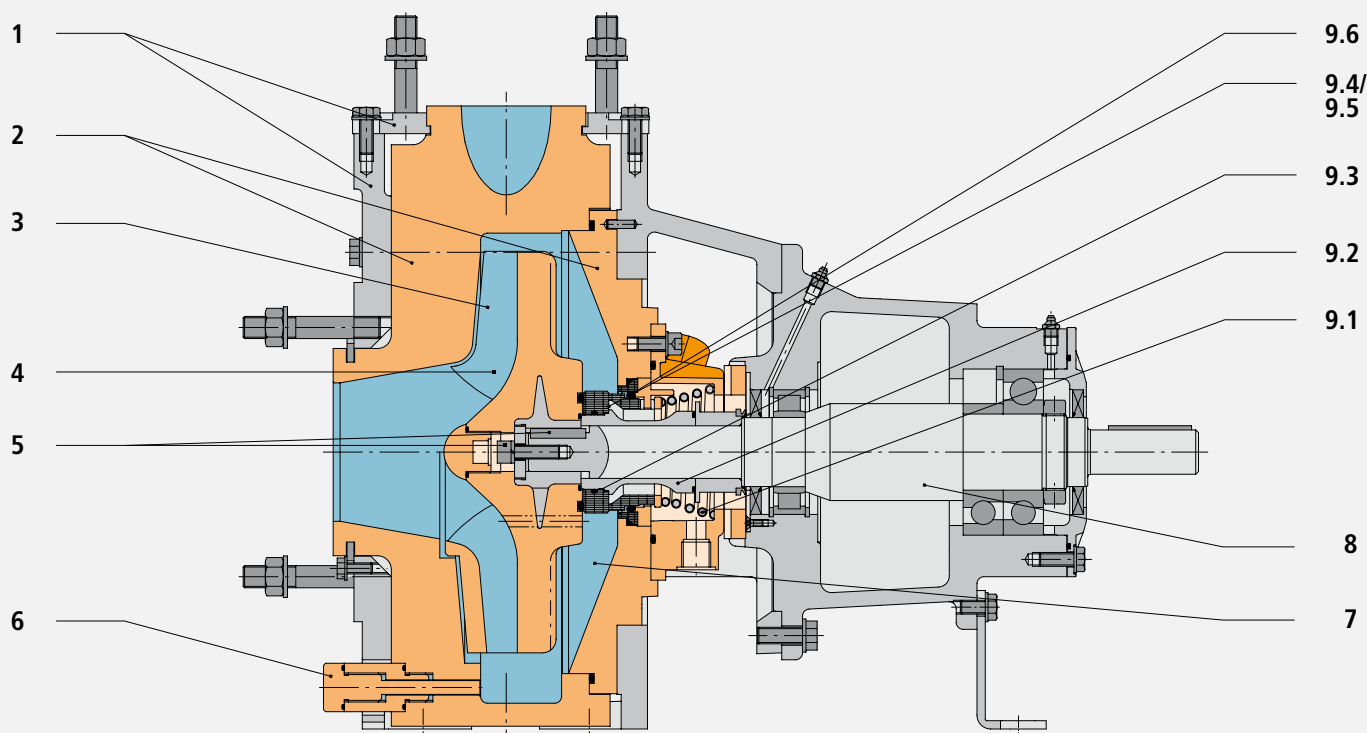

► Design features

- | | |
|--|--|
| <p>1 Robust metal armour accommodates all allowable system pressures and piping loads.</p> <p>2 Sturdy, single-piece plastic casing and solid casing cover provide diffusion-tight containment, eliminating secondary sealing problems; superior mechanical wear resistance for maximum operating reliability in chemically aggressive and abrasive environments.</p> <p>3 Impeller available in closed and semi-open designs.</p> <p>4 Optimum hydraulic design using the latest numerical methods ensures: good suction behaviour due to low NPSH requirements, minimum mechanical vibration of components, long service lives of antifriction bearings and mechanical seal, minimized running noise.</p> <p>5 Impeller is keyed to the shaft and is therefore bi-directional and unaffected by inadvertent reverse rotation.</p> <p>6 Casing drain or connection to cleaning circuit (option).</p> <p>7 Optimum seal chamber geometry without dead flow pockets ensures continuous liquid exchange.</p> <p>8 Excellent shaft rigidity makes for long service life of the mechanical seal.</p> | <p>9 The MUNSCH-REA mechanical seal is a direction of rotation-independent mechanical seal with stationary springs that has been specifically developed for MUNSCH non-metallic pumps. Special feature: insensitive to solids-laden fluids; the rotating seal ring keeps solids clear of the seal faces.</p> <p>9.1 The fluoroplastics coated spring is located outside the path of the fluid pumped.</p> <p>9.2 The CrNiMo shaft sleeve is provided with a fluoroplastics coating and positively locked to the shaft.</p> <p>9.3 The rotating seal ring is positively locked to the shaft sleeve.</p> <p>9.4 Rotating and stationary seal rings are fabricated from. This advanced silicon carbide not only offers extreme abrasion resistance but is also resistant to virtually all acids and alkalis.</p> <p>9.5 The rotating seal ring design with a larger outer diameter counteracts edge pressure effectively.</p> <p>9.6 Dynamic O-ring optimally positioned between the SSiC components ensures reliable sealing over the full range of allowable service temperatures.</p> <p>9.7 Disassembly or assembly of the mechanical seal requires no special skills. No adjustment or alignment needed (not shown). Single mechanical seal can be readily converted to a double mechanical seal</p> |
|--|--|

► Shaft seals – flushing options

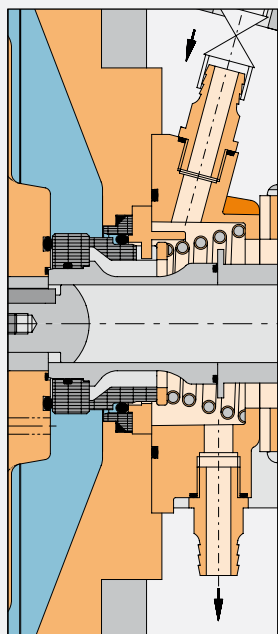

10) Spring chamber flushing connection

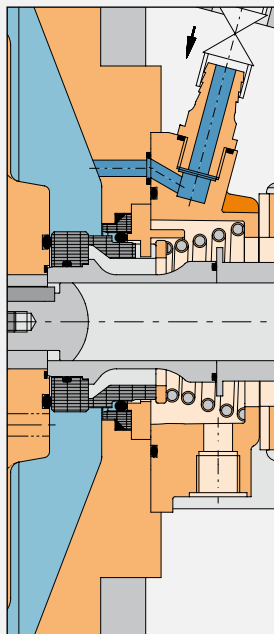

11) Shutdown flushing

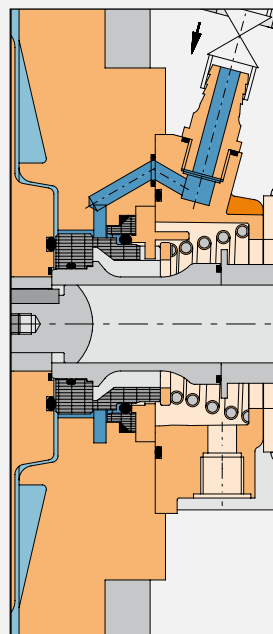

12) Continuous flushing

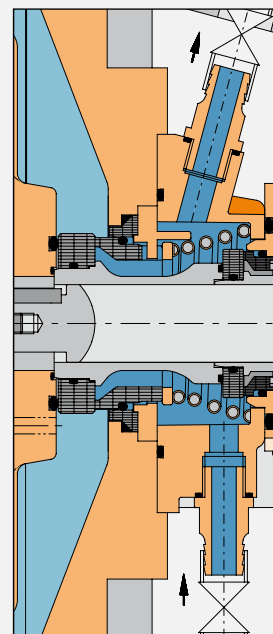

13) Double mechanical seal

- 10** **MUNSCH-REA mechanical seal with spring chamber flushing connection (option)**
A spring chamber flushing connection is provided whenever there is a risk of product crystallization or solids deposition in the spring chamber

- 11** **Shutdown flushing (option)**
This shaft seal flushing variant is used in service environments involving a risk of solids deposition, crystallization of the fluid pumped or blockage problems in the pump interior. It can be combined with the double mechanical seal MUNSCH-REA-F/D.

- 12** **Continuous flushing (option)**
The continuous shaft seal flushing variant ensures reliable protection when pumping fluids containing high solids loads or dissolved gases, when the fluid is pumped near its boiling point or when there is a risk of dry running.

- 13** **MUNSCH-REA-F/D double mechanical seal**
The double mechanical seal is employed whenever there is a risk of solids deposition or product crystallization, in service environments posing a health or environmental hazard, when the fluid is pumped near its boiling point or dry running cannot be ruled out with a single mechanical seal.

The double mechanical seal can be operated with a buffer fluid in the once-through mode, with closed-circuit thermosiphon buffer systems or quench systems.

Accessories / Options

- Base plate
- Levelling bolts as an alternative to concrete pads
- Coupling with/without spacer sleeve
- Coupling guard
- Priming pot
- Thermosiphon buffer system
- Quench tank
- Motor overload switch
- Casing drain

Explosion protection to EU Directive 94/9/EG (option)

Additional constructional measures allow the use of the NP in explosion hazard areas. The pump meets the requirements of EU Directive No. 94/9/EG.

► Performance characteristic charts

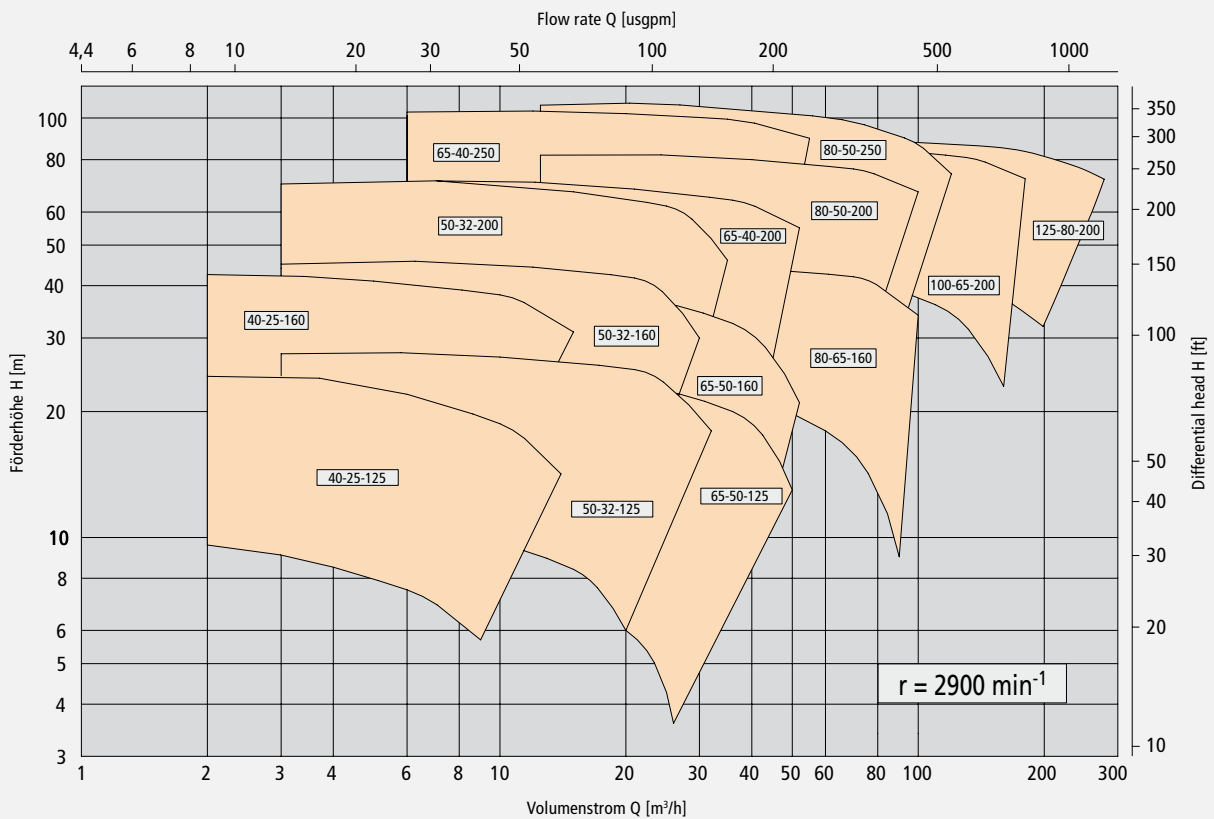
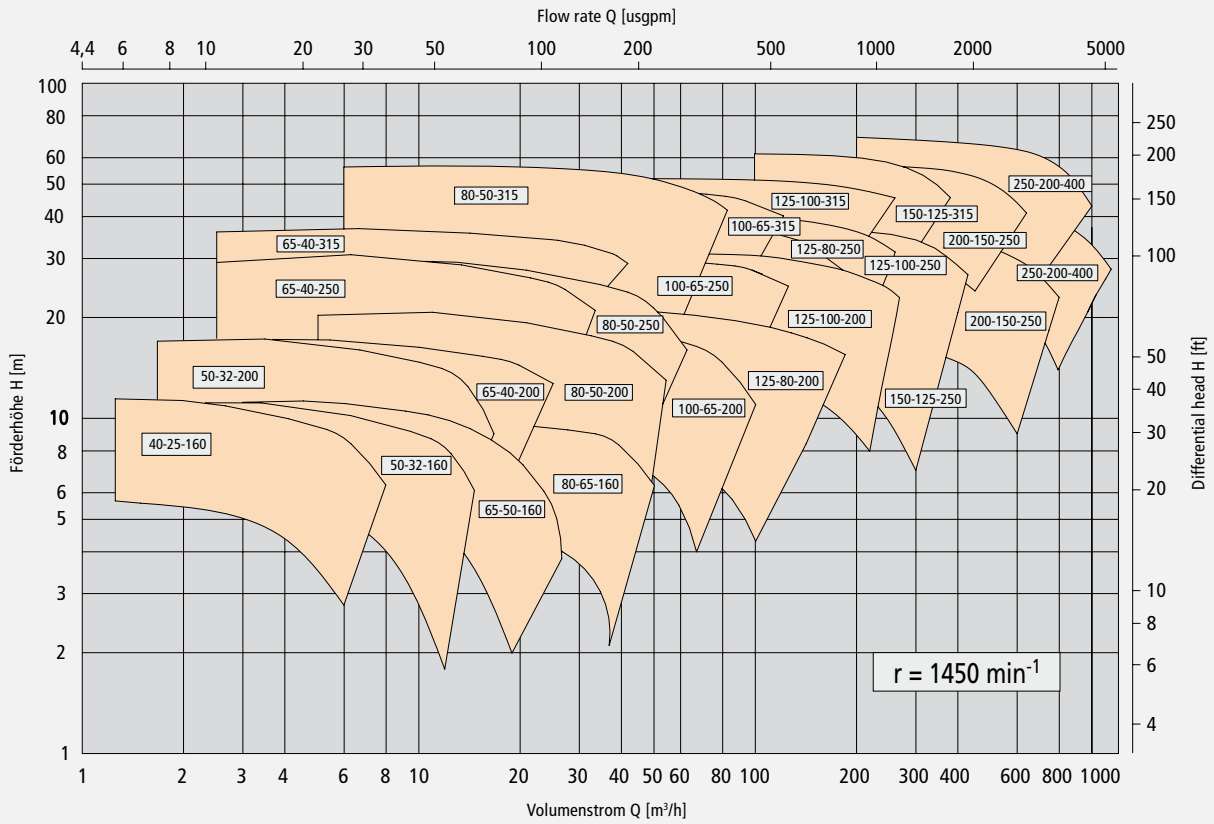

Standardized chemical pump NP

MKFB0005

Dimensions, weights and connections

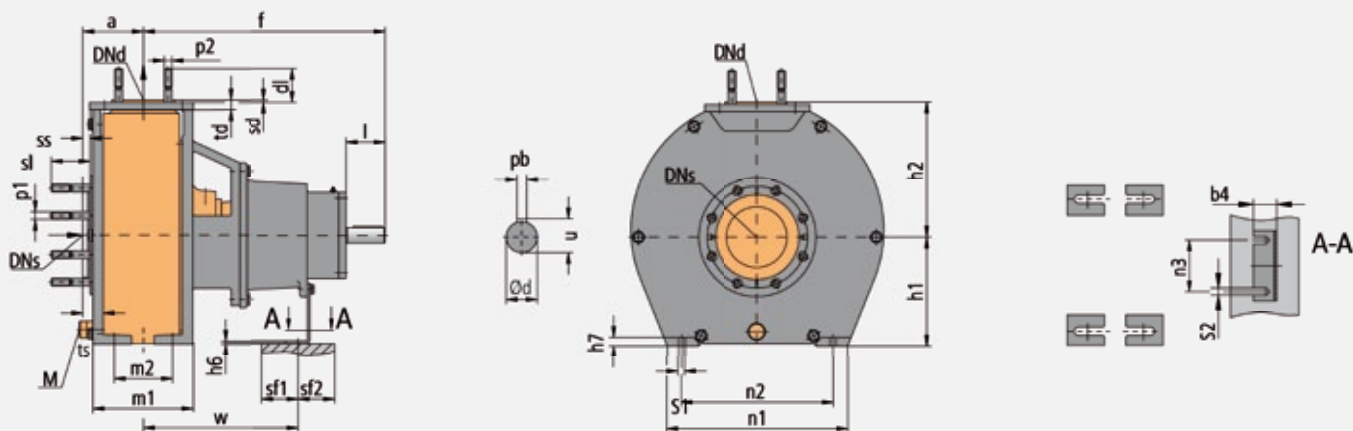

Pump size	Weights																													
	DNs ¹⁾	DNd ¹⁾	PP/PE	PVDF	a	f	h1	h2	m1	m2	n1	n2	n3	w	S1	S2	sf1	sf2	td	ts	h6	h7	b4	Ød	l	pb	u	M ²⁾		
40-25-160 ³⁾	40	25	55	66	80	385	132	160	145	70	240	190	110	285	14	15	75	75	20	32,5	6	15	50	24	50	8	27	-		
50-32-160	50	32	55	66	80	385	132	160	145	70	240	190	110	285	14	15	75	75	20	32,5	6	15	50	24	50	8	27	-		
50-32-200	50	32	66	80	80	385	160	180	155	70	265	212	110	285	14	15	75	75	20	34	6	15	50	24	50	8	27	•		
65-40-200	65	40	66	80	100	385	160	180	175	70	265	212	110	285	14	15	75	75	20	34	6	15	50	24	50	8	27	•		
65-40-250	65	40	106	125	100	500	180	225	180	95	335	280	110	370	14	15	75	75	20	42	6	17	50	32	80	10	35	•		
65-40-315	65	40	125	150	125	500	200	250	205	95	375	315	110	370	17	15	75	75	20	42	6	18	50	32	80	10	35	•		
65-50-160	65	50	55	66	80	385	132	160	145	70	240	190	110	285	14	15	75	75	20	32,5	6	15	50	24	50	8	27	-		
80-50-200	80	50	66	80	100	385	160	200	175	70	265	212	110	285	14	15	75	75	20	34	6	15	50	24	50	8	27	•		
80-50-250	80	50	110	130	125	500	180	225	205	95	335	280	110	370	14	15	75	75	20	42	6	17	50	32	80	10	35	•		
80-50-315	80	50	135	160	125	500	225	280	205	95	375	315	110	370	17	15	75	75	20	42	6	18	50	32	80	10	35	•		
80-65-160	80	65	66	80	100	385	160	180	175	70	265	212	110	285	14	15	75	75	20	34	6	15	50	24	50	8	27	•		
100-65-200	100	65	110	130	100	500	180	225	180	95	335	280	110	370	14	15	75	75	20	42	6	17	50	32	80	10	35	•		
100-65-250	100	65	125	150	125	500	200	250	205	120	375	315	110	370	17	15	75	75	20	42	6	18	50	32	80	10	35	•		
100-65-315	100	65	135	160	125	530	225	280	205	120	375	315	110	370	17	15	75	75	20	42	6	18	50	42	110	12	45	•		
125-80-200	125	80	110	130	125	500	180	250	205	95	335	280	110	370	14	15	75	75	20	42	6	17	50	32	80	10	35	•		
125-80-250	125	80	135	160	125	500	225	280	205	120	375	315	110	370	17	15	75	75	20	42	6	18	50	32	80	10	35	•		
125-100-200	125	100	125	150	125	500	200	280	205	120	375	315	110	370	17	15	75	75	20	42	6	18	50	32	80	10	35	•		
125-100-250	125	100	135	160	140	530	225	280	220	120	375	315	110	370	17	15	75	75	20	42	6	18	50	42	110	12	45	•		
125-100-315	125	100	165	-	140	530	250	315	230	120	415	315	110	370	18	15	75	75	25	45	6	20	65	42	80	12	45	•		
150-125-250	150	125	165	-	140	530	250	355	230	120	415	315	110	370	18	15	75	75	25	45	6	20	65	42	80	12	45	•		
150-125-315	150	125	210	250	140	530	280	355	245	150	500	400	110	370	22	15	75	75	25	45	6	20	65	42	80	12	45	•		
200-150-250	200	150	210	250	160	530	280	375	265	150	500	400	110	370	22	15	75	75	25	45	6	20	65	42	80	12	45	•		
250-200-400	250	200	425	-	200	670	315	450	350	200	595	540	140	500	24	22	75	75	40	60	6	32	140	48	90	14	51,5	•		

Dimensions in [mm]

Weights in [kg]

Pump sizes 125-80-315, 125-80-400, 125-100-400, 200-150-400 on request

1) Flanged connection to DIN 2501, PN 16

2) M = casing drain: • = available (option), - = not available

3) Not available in PE-UHMW

Pump size	DNs	p1	DNd	p2	sd	dl	ss	sl
40-25-160	40	M16	25	M12	5	60	11,5	70
50-32-160	50	M16	32	M16	5	60	11,5	70
50-32-200	50	M16	32	M16	5	60	12	70
65-40-200	65	M16	40	M16	5	60	12	70
65-40-250	65	M16	40	M16	5	60	15	80
65-40-315	65	M16	40	M16	5	60	15	80
65-50-160	65	M16	50	M16	5	60	11,5	70
80-65-160	80	M16	65	M16	5	70	12	80
80-50-200	80	M16	50	M16	5	70	12	80
80-50-250	80	M16	50	M16	5	70	15	80
80-50-315	80	M16	50	M16	5	70	15	80

Pump size	DNs	p1	DNd	p2	sd	dl	ss	sl
100-65-200	100	M16	65	M16	5	70	15	80
100-65-250	100	M16	65	M16	5	70	15	80
100-65-315	100	M16	65	M16	5	70	15	80
125-80-200	125	M16	80	M16	5	70	15	90
125-80-250	125	M16	80	M16	5	70	15	90
125-100-200	125	M16	100	M16	5	70	15	90
125-100-250	125	M16	100	M16	5	70	15	90
125-100-315	125	M16	100	M16	5	70	15	90
150-125-250	150	M20	125	M16	5	80	15	100
150-125-315	150	M20	125	M16	5	80	15	100
200-150-250	200	M20	150	M20	5	90	15	110
250-200-400	250	M24	200	M20	10	100	20	120

MUNSCH Chemie-Pumpen GmbH

Im Staudchen · D-56235 Ransbach-Baumbach

P. O. Box 1 42 · D-56221 Ransbach-Baumbach

Germany

Phone: +49 (0) 2623-8 98-90

Fax: +49 (0) 2623-8 98-95

Internet: <http://www.munsch.de>

E-Mail: munsch@munsch.de

Size h1 = 112 on request.